







## Bianca Care Shower Mixer 60mm Plate

### Finish & SKU

 <b>Chrome</b> NR321511eCH	 <b>Brushed Nickel</b> NR321511eBN
 <b>Matte Black</b> NR321511eMB	 <b>Brushed Gold</b> NR321511eBG
 <b>Brushed Bronze</b> NR321511eBZ	 <b>Gun Metal</b> NR321511eGM

### Specifications

#### Watermark License

WM-060073

#### Temperature Rating

Min 1°C-Max 75°C

#### Pressure Rating

Min 150kpa-Max 500kpa

### Warranty



### Features

- Large colour indicators – ideal for aged care applications 35mm ceramic cartridge can be adjusted to control water temperature and flow control setting, saving energy
- Metal wall plate construction for longevity
- Body inlets – ½ BSP female
- Suitable for mains pressure installation
- WELS rating not required
- Replaceable trim kits
- Packed Separately (Body and Trim Kits)

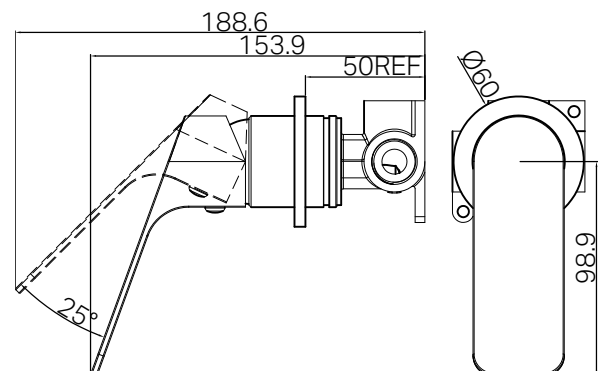

### Maintenance And Care

- Regularly check the mixer and connections for signs of wear or leaks.
- Clean the tap with mild soapy water to maintain its appearance, avoiding harsh chemicals and abrasive materials that may damage the finish.

- Dimensions are nominal measurements only.