







Mecca Care Make Your Own 32mm Grab Rail 90 Degree Bracket

Finish & SKU

 Chrome NR5390428CH	 Brushed Nickel NR5390428BN
 Matte Black NR5390428MB	 Brushed Gold NR5390428BG
 Brushed Bronze NR5390428BZ	 Gun Metal NR5390428GM



Specifications

Watermark License

#N/A

Temperature Rating

Min 1°C-Max 75°C

Pressure Rating

Min 150kpa-Max 500kpa

Warranty



Features

- This 90 degree bracket can be used to create a junction for a vertical and horizontal rail
- Suits 32mm Diameter Grab rails
- The ends of the rails slot into the brackets
- 150kg Capacity when installed correctly
- AS1428.1 Compliant for Grabrails
- Includes Mounting Bracket set with screws and wall plugs
- Can be added to existing Mecca Care Grab Rail sets to create new combinations

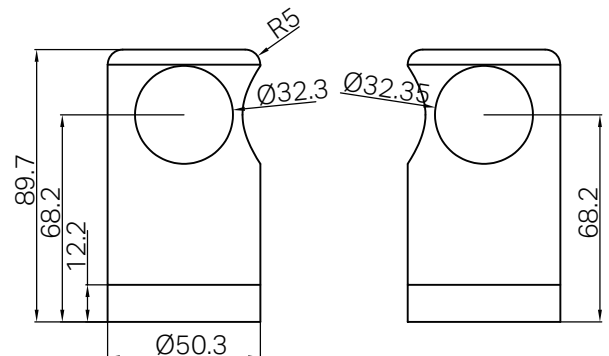

Maintenance And Care

- Regularly check the mixer and connections for signs of wear or leaks.
- Clean the tap with mild soapy water to maintain its appearance, avoiding harsh chemicals and abrasive materials that may damage the finish.

- Dimensions are nominal measurements only.