





## 100mm Square Tile Insert Floor Waste 50mm Outlet

### Finish & SKU

 <b>Matte Black</b> NRFW006MB	 <b>Brushed Nickel</b> NRFW006BN
 <b>Brushed Gold</b> NRFW006BG	 <b>Gun Metal</b> NRFW006GM
 <b>Brushed Bronze</b> NRFW006BZ	



### Specifications

#### Watermark License

WM-032203

#### Temperature Rating

Min 1°C-Max 75°C

#### Pressure Rating

Min 150kpa-Max 500kpa

### Warranty



### Features

- Manufactured from 304 stainless steel
- Slimline for easy installation
- 50mm outlet

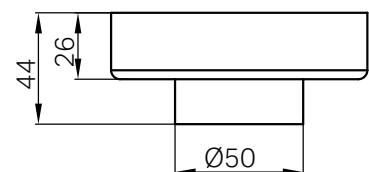
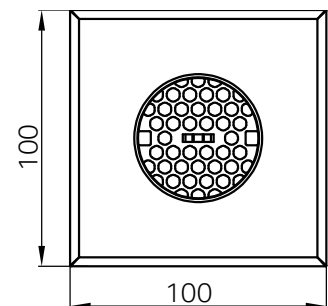

### Maintenance And Care

- Regularly check the mixer and connections for signs of wear or leaks.
- Clean the tap with mild soapy water to maintain its appearance, avoiding harsh chemicals and abrasive materials that may damage the finish.

- Dimensions are nominal measurements only.