

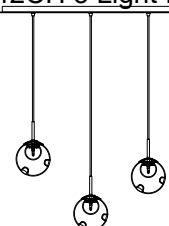

At Home In Any Environment

**Assembly & Installation Instructions for:
309542CH 3 Light Island**

Customer Service : (702)361-4345, (800)525-2655, customer.service@kalco.com



WARNING - TO REDUCE THE RISK OF FIRE OR INJURY:

1. If you are unfamiliar with electrical wiring, call a qualified electrician to install this unit. More than one person may be necessary to install fixture, make sure you have enough qualified help.
2. Turn off the power to the fixture's circuit at the service panel. Use a voltage detector to verify that the power is off.
3. DO NOT install bulb which exceeds the maximum wattage specified on the socket label.

Fixture Assembly

Step 1. Assemble the center pipe of the main fixture to the distributor as shown. Lock in place by twisting stem onto distributor.

Step 2. Fasten 2 8-32 screws to mounting plate so that they extend away from the wall when mounting plate is installed

Step 3. Attach mounting plate to electrical box using 2 8-32 machine screws

Step 4. Screw part Glass ball to part Steeve.

Step 5. Fix part Rolling plate to part Steeve by using part Safety screw.

Step 6. Screw part screw to part Rolling plate.

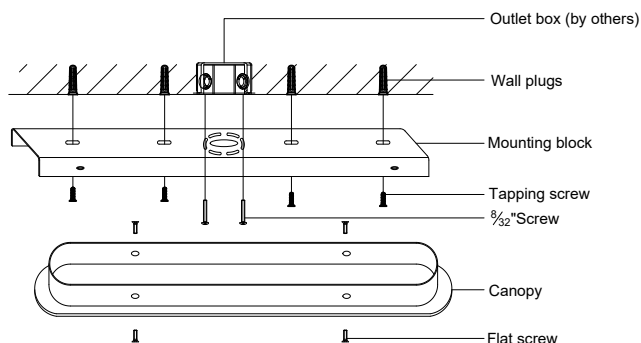
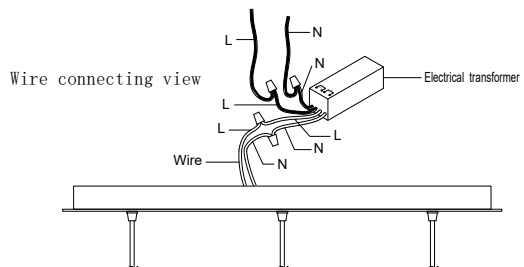
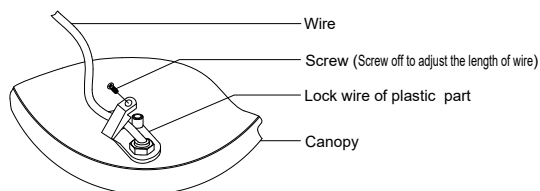
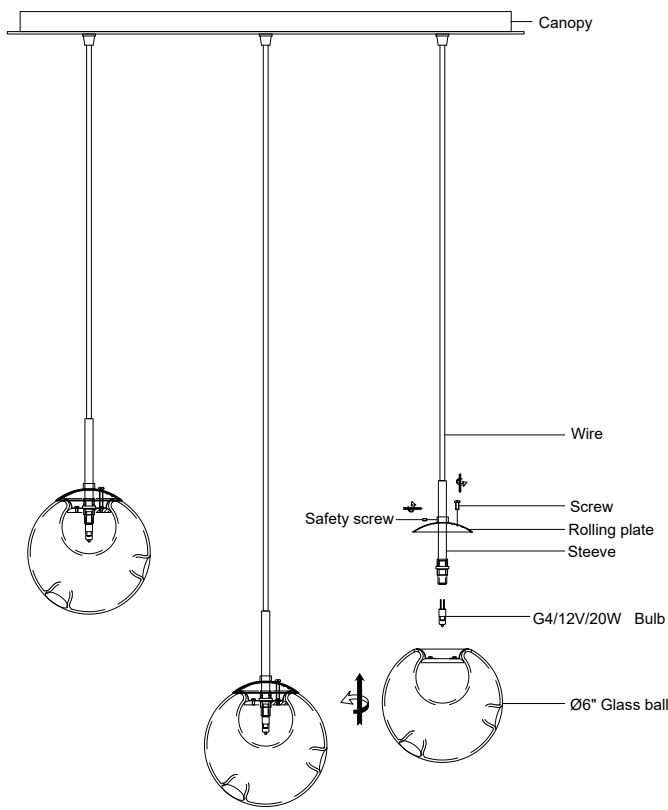



At Home In Any Environment

Assembly & Installation Instructions for:
309542CH 3 Light Island

Customer Service : (702)361-4345, (800)525-2655, customer.service@kalco.com

Fixture Assembly

Step 7. Refer to wiring diagram.

Splice the ribbed side of fixture cord to the white supply wire from outlet box with wire connector. Splice the smooth side of the fixture cord to black supply wire from outlet box with wire connector

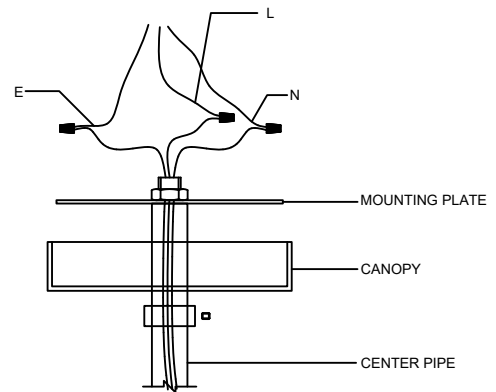

Step 8. Carefully tuck in all wires and raise the canopy to the outlet box . Secure canopy with nuts

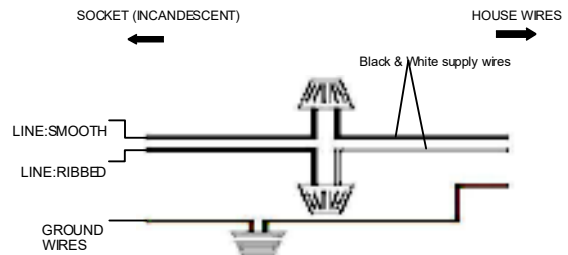

Step 9. Install G4 12V bulbs, do not use bulbs that exceeds 20W.

