



At Home In Any Environment

**Assembly & Installation Instructions for:
311353PN Pendant lamp**



Customer Service : (702)361-4345, (800)525-2655, customer.service@kalco.com

WARNING - TO REDUCE THE RISK OF FIRE OR INJURY:

1. If you are unfamiliar with electrical wiring, call a qualified electrician to install this unit. More than one person may be necessary to install fixture, make sure you have enough qualified help.
2. Turn off the power to the fixture's circuit at the service panel. Use a voltage detector to verify that the power is off.
3. DO NOT install bulb which exceeds the maximum wattage specified on the socket label.

Fixture Assembly

- Step 1. Assemble the center pipe of the main fixture to the distributor as shown. lock in place by twisting stem onto distributor
- Step 2. Fasten 2 8-32 screws to mounting plate so that they extend away from the wall when mounting plate is installed
- Step 3. Attach mounting plate to electrical box using 2 8-32 machine screws
- Step 4. Fix part glass shade, Rubber washer to part main body by using metal ring.
- Step 5. Screw bulb into lampholder.
- Step 6. Screw part stud to part Metal ball.
- Step 7. Fix part Metal frame to part Glass shade by using Stud, Metal ball.

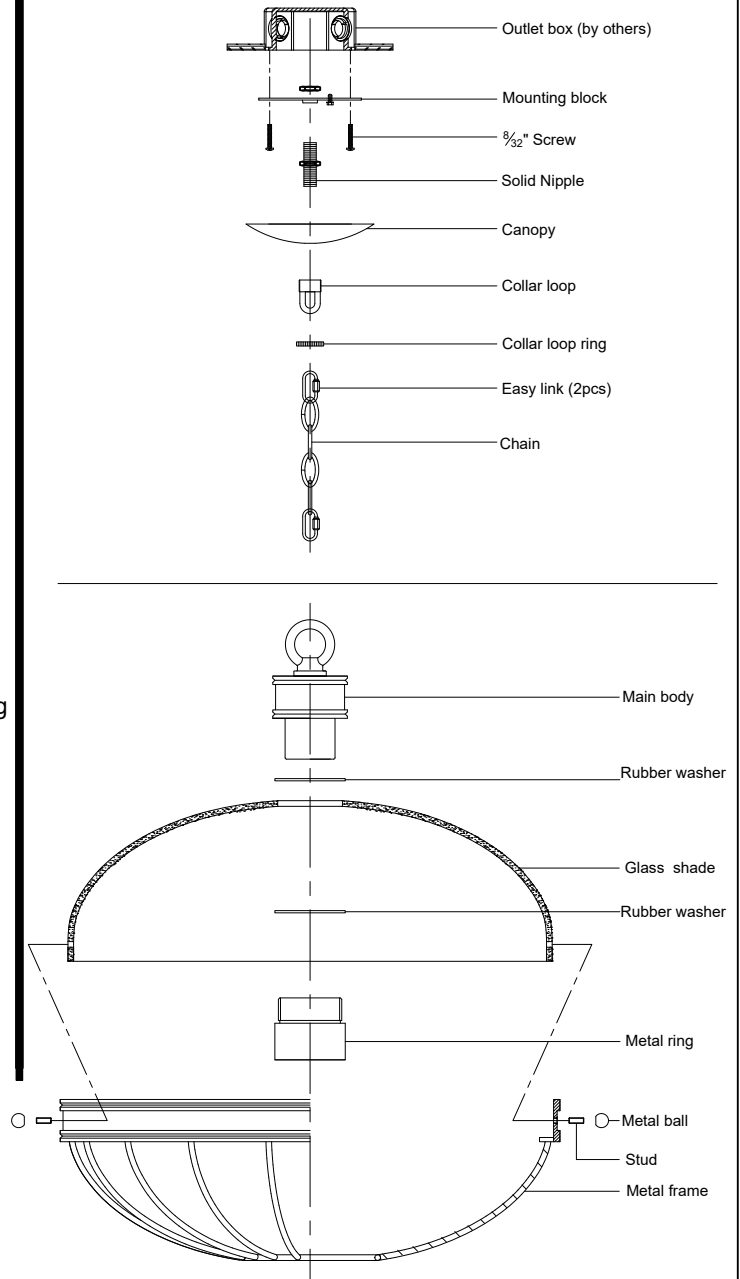



At Home In Any Environment

**Assembly & Installation Instructions for:
311353PN Pendant lamp**

Customer Service : (702)361-4345, (800)525-2655, customer.service@kalco.com

Fixture Assembly

Step 8. Refer to wiring diagram.
Splice the ribbed side of fixture cord to the white supply wire from outlet box with wire connector. Splice the smooth side of the fixture cord to black supply wire from outlet box with wire connector

Step 9. Carefully tuck in all wires and raise the canopy to the outlet box . Secure canopy with nuts

Step 10 Install E26 bulbs, do not use bulbs that exceeds 100W.

