

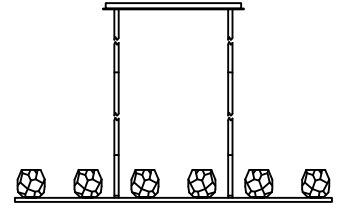

At Home In Any Environment

Assembly & Installation Instructions for:  
311760WB Pendant lamp

Customer Service :(702)361-4345,(800)525-2655,customer.service@kalco.com



**WARNING - TO REDUCE THE RISK OF FIRE OR INJURY:**

- 1.If you are unfamiliar with electrical wiring, call a qualified electrician to install this unit .More than one person may be necessary to install fixture ,make sure you have enough qualified help.
- 2.Turn off the power to the fixture's circuit at the service panel. Use a voltage detector to verify that the power is off.
- 3.DO NOT install bulb which exceeds the maximum wattage specified on the socket label.

**Fixture Assembly**

Step 1. Place mount mounting and wiring steps before crystal installation step

Step 2. Assemble crystal bowl to the lamp body as shown,Align holes in crystal bowl with holes in fixture and secure crystal bowl to fixture using headless screw

Step 3. Install G9 base bulb,do not use bulbs that exceeds 40W

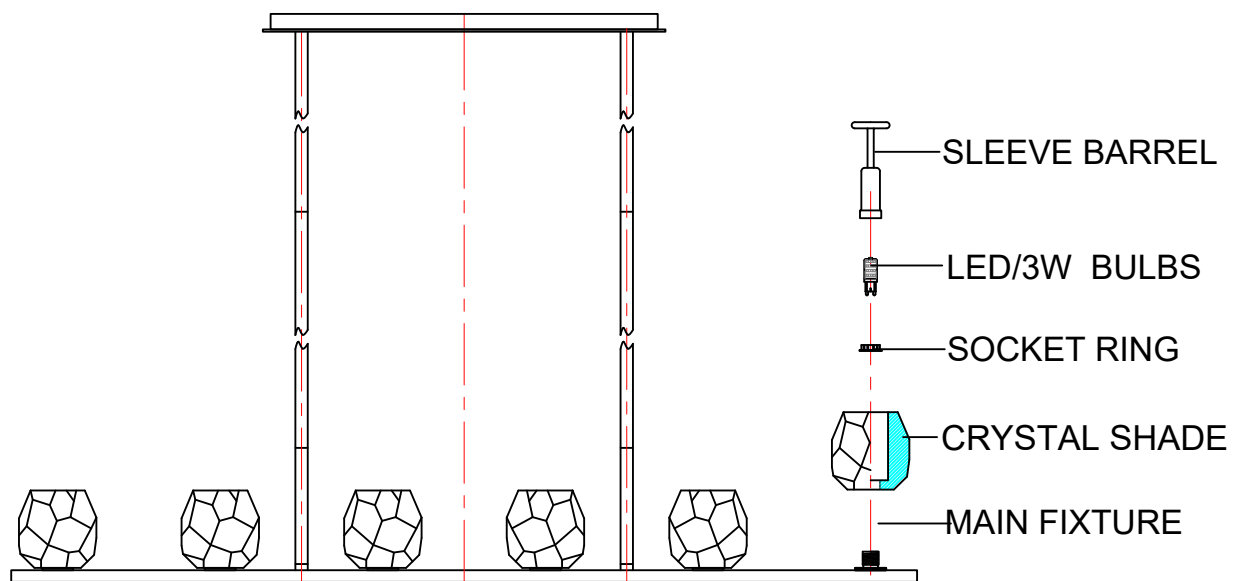
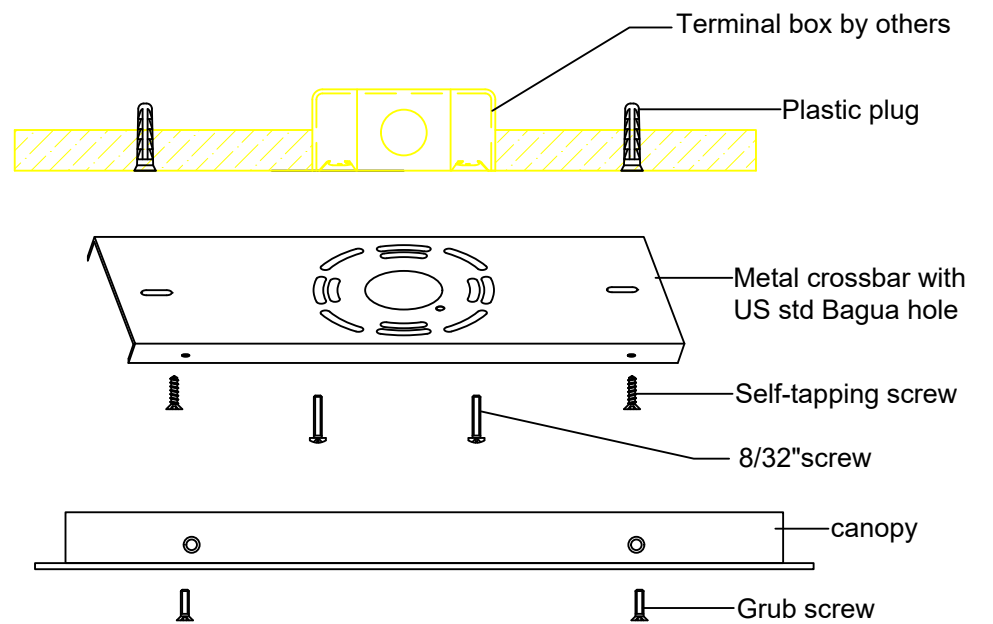



At Home In Any Environment

## Assembly & Installation Instructions for: 311760WB Pendant lamp

Customer Service :(702)361-4345,(800)525-2655,customer.service@kalco.com

### Fixture Assembly

Step 6. Fasten 2 (state specification of screw ) into mounting plate so that they extend away from wall when mounting plate is installed

Step 7. Attach the mounting plate to outlet box with screws

Step 8. Refer to wiring diagram.  
Splice the ribbed side of fixture cord to the white supply wire from outlet box with wire connector. Splice the smooth side of the fixture cord to black supply wire from outlet box with wire connector

Step 9. Carefully tuck in all wires Attach the back plate with the mounting screw on the crossbar. Secure fixture with shell knobs.

