

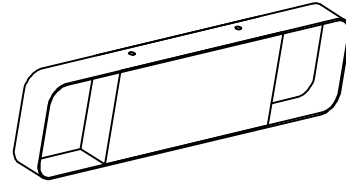

KALCO.
Handcrafted Since 1980™

Assembly & Installation Instructions for:
ITEM NO.: 316433BM



Customer Service :(702)361-4345,(800)525-2655,customer.service@kalco.com

WARNING - TO REDUCE THE RISK OF FIRE OR INJURY:

- 1.If you are unfamiliar with electrical wiring, call a qualified electrician to install this unit. More than one person may be necessary to install fixture, make sure you have enough qualified help.
- 2.Turn off the power to the fixture's circuit at the service panel. Use a voltage detector to verify that the power is off.
3. DO NOT install bulb which exceeds the maximum wattage specified on the socket label.

Fixture Assembly

- 1** Step 1. Attach mounting plate to junction box using 2 M4 screws.

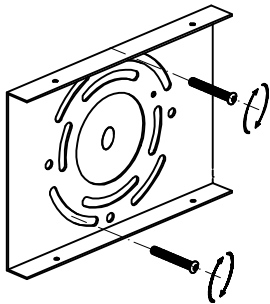

- 2** Step 2. Connect the wires from fixture to wires from junction box with wire connectors. Pls make sure it is grounded properly.

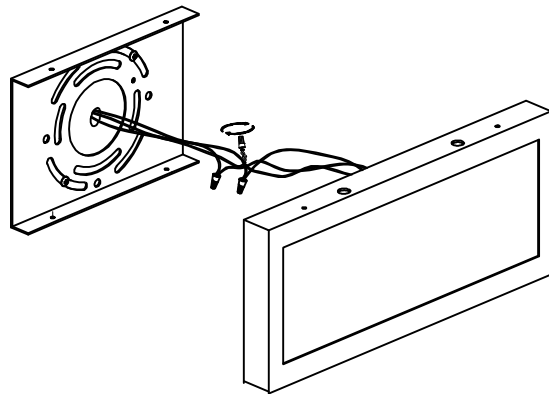

- 3** Step 3. Attach the fixture body over mounting plate and secure it with 4 supplied screws.

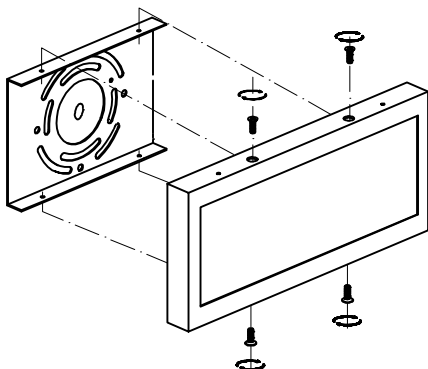

- 4** Step 4. Fit the glass diffuser to fixture body and then the outer frame over glass diffuser, secure them with 4 supplied screws on top and at bottom.

