

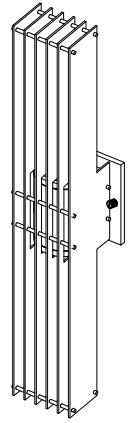

KALCO
Handcrafted Since 1980™
www.kalco.com

Assembly & Installation Instructions for :
ITEM NO.: 404924MB



Customer Service : (800)525-2655, customercare@kalco.com

WARNING - TO REDUCE THE RISK OF FIRE OR INJURY:

1. This product must be installed in accordance with the applicable installation code by a person familiar with the construction and operation of the product and the hazards involved.
2. If you are unfamiliar with electrical wiring, call a qualified electrician to install this unit. More than one person may be necessary to install fixture, make sure you have enough qualified help.
3. Turn off the power to the fixture's circuit at the service panel. Use a voltage detector to verify that the power is off.
4. This fixture includes integrated LED module.

Fixture Assembly

- 1** Step 1. Attach the crossbar to junction box using 2 M4 screws.

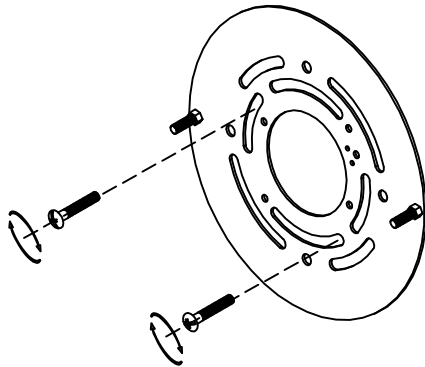

- 2** Step 2. Connect the wires from fixture to wires from junction box with wire connectors.

* Make sure the gasket is attached to the back of wall canopy.

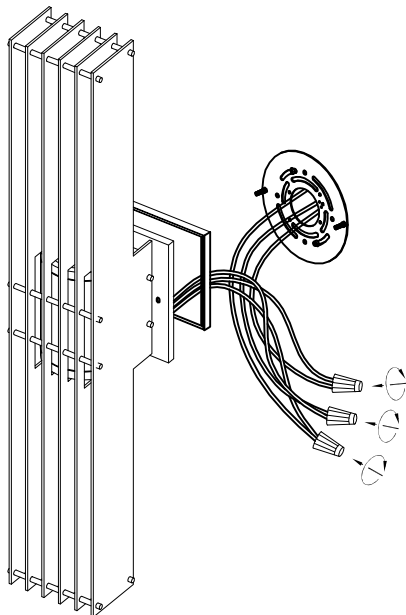

- 3** Step 3. Attach the fixture body over the crossbar and secure it with 2 supplied knobs tightly against the wall.

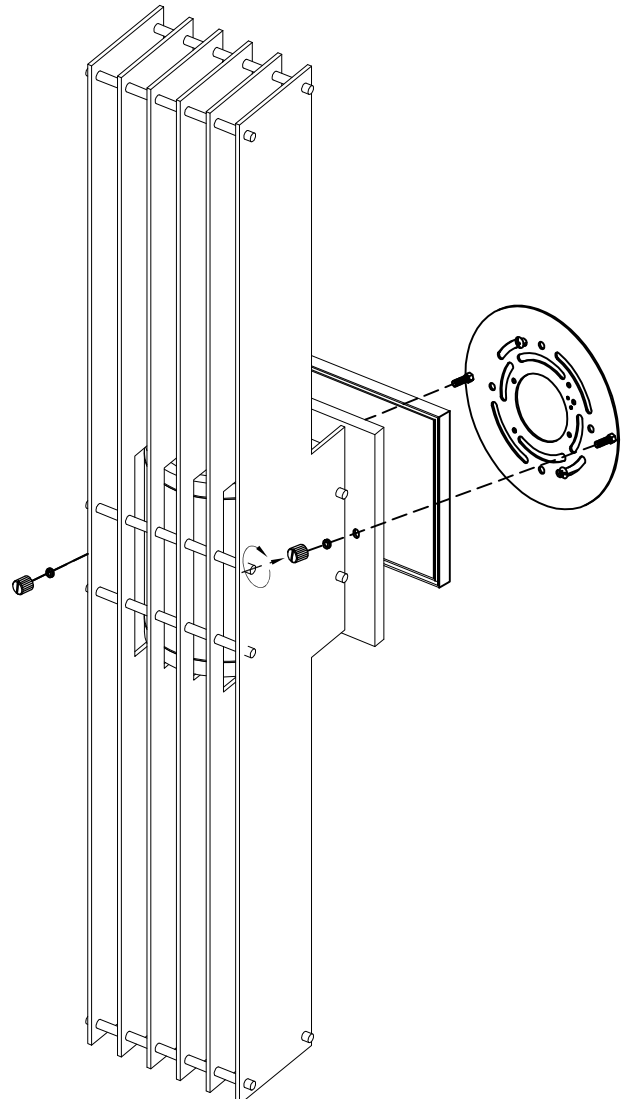



KALCO
Handcrafted Since 1980[™]
www.kalco.com

Customer Service : (800) 525-2655, customercare@kalco.com

WARNING:

To reduce risk of water entry into the fixture and prevent damages, please mount on a flat surface and apply caulking as indicated in the illustration below.

1 Wall must be flat and smooth by contractor.

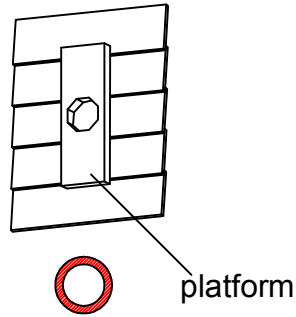
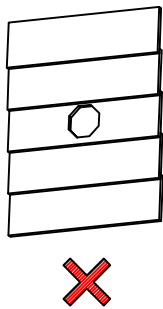

2 Make sure the silicone gasket is attached at the back of fixture canopy.
When the fixture assembly mounts on the wall, the gasket is located around J-box.

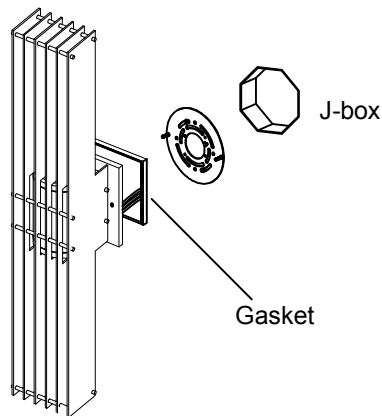

3 Continuous caulking must be applied between the wall and fixture canopy by contractor.

