



KALCO.
Handcrafted Since 1980

ASSEMBLY & INSTALLATION INSTRUCTIONS

MODEL: 506273MGM
STUYVESANT 28 LIGHT 2-TIER CHANDELIER

I M A G E



If you have any questions or problems assembling your fixture please call us for assistance.

Customer Service: (702) 361-4345 or (800) 525-2655
customer.services@kalco.com

WARNING! TO REDUCE THE RISK OF FIRE OR INJURY PLEASE TAKE PRECAUTION AND FOLLOW THE STEPS BELOW.

1. If you are unfamiliar with electrical wiring, call a qualified electrician to install this unit. More than one person may be necessary to install fixture, make sure you have enough qualified help.
2. Turn off the power to the fixture's circuit at the service panel. Use a voltage detector to verify that the power is off.
3. DO NOT install bulb which exceeds the maximum wattage specified on the socket label.

Si vous avez des questions ou des problèmes assemblage de votre dispositif s'il vous plait appel pour l'assistance.

Customer Service: (702) 361-4345 or (800) 525-2655
customer.services@kalco.com

AVERTISSEMENT! POUR RÉDUIRE LES RISQUES D'INCENDIE OU DE BLESSURES S'IL VOUS PLAÎT PRENDRE DES PRÉCAUTIONS ET SUIVEZ LES ÉTAPES CI-DESSOUS.

1. Si vous n'êtes pas familier avec le câblage électrique, appelez un électricien qualifié pour installer cet appareil. Plus d'une personne peut être nécessaire d'installer appareil, assurez vous que vous disposez de l'aide assez qualifié.
2. Coupez l'alimentation au circuit de l'appareil sur le tableau de service. Utiliser un détecteur de tension pour vérifier que l'alimentation est coupée
3. NE PAS installer l'ampoule qui excède la puissance maximale indiquée sur l'étiquette du socket.

WIRING DIAGRAM

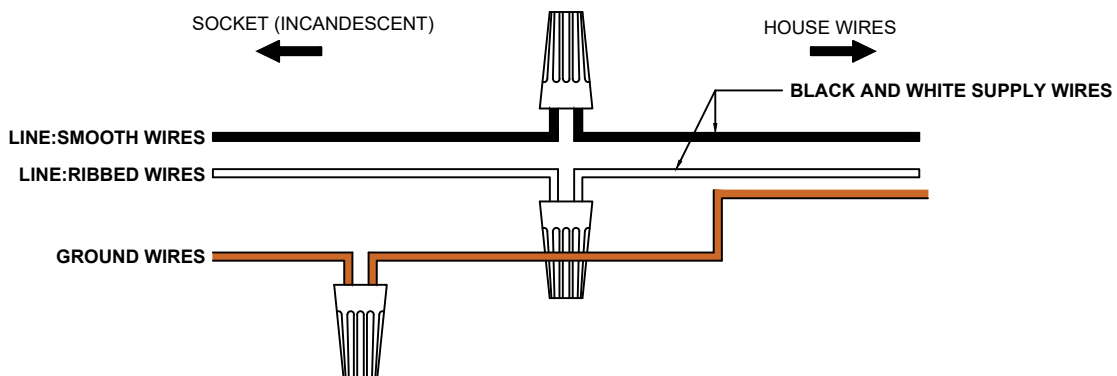



KALCO
Handcrafted Since 1980

ASSEMBLY & INSTALLATION INSTRUCTIONS

MODEL: 506273MGM
STUYVESANT 28 LIGHT 2-TIER CHANDELIER

CEILING BRACE OPTIONS

" METHOD A "

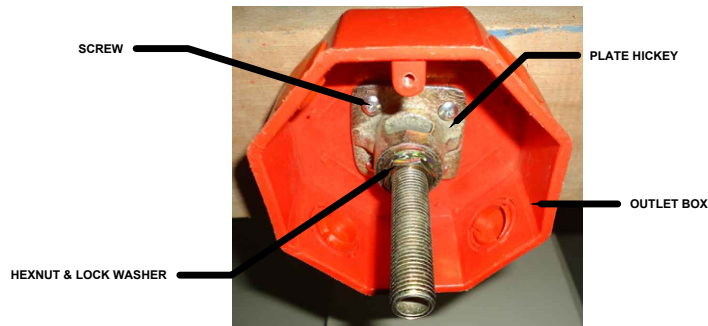

Brace is directly on top of the outlet box and not accessible).

Using a 1/8" drill bit, pre-drill (4) holes into the wood brace through the (4) hole pattern in the outlet box. (Outlet box is shown as a cutaway for Clarity). Secure the hickey to the brace with (4) #8 x 1-1/2" screws. The wire way opening should mount as shown, between the outlet box and 2 mounting flanges.

" METHOD B "

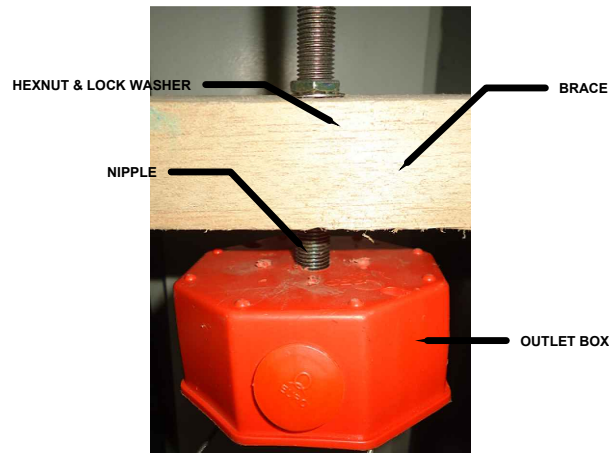

(Brace is above and not in contact with the outlet box and is accessible)

Remove center knockout from outlet box. In line with the center knockout, drill a 9/16" hole in the brace. (Brace should be fastened to the ceiling joist after pipe is installed). Assemble hickey to one end of a 1/4 pipe nipple. The pipe should be flush with inside of the hickey wire way. Insert pipe through back of outlet box and through the brace above. Secure pipe with a 1/4 pipe nut.



ASSEMBLY & INSTALLATION INSTRUCTIONS

MODEL: 506273MGM
STUYVESANT 28 LIGHT 2-TIER CHANDELIER

KALCO
Handcrafted Since 1980

KNOCK DOWN ASSEMBLY

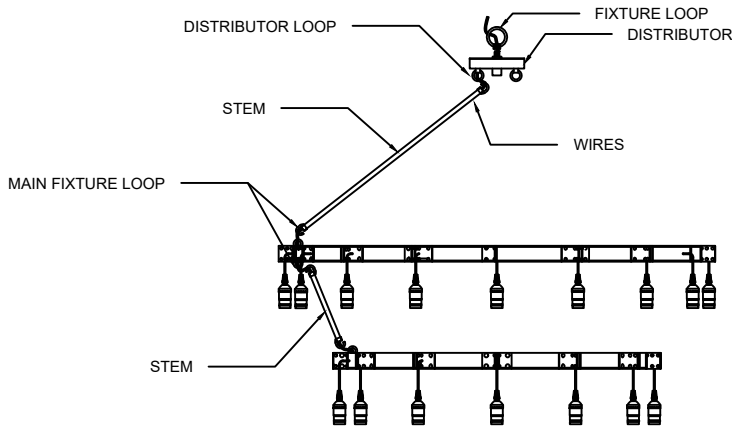

STEP 1: Attach the fixture loop to the distributor, then attach all stem with hook to the main fixture loop and distributor loop. (Make sure, wires are properly inserted on the distributor.)

ELECTRICAL / MOUNTING INSTALLATION

⚠ WARNING

REFER TO THE ILLUSTRATION FOR CORRECT AND SAFE INSTALLATION OF SAFETY CABLE. FAILURE TO FOLLOW THIS INSTRUCTION COULD RESULT HARM/DAMAGE TO THE FIXTURE, PROPERTY AND/OR PERSON(S)

- STEP 2:** Assemble nipple and collar loop to cast hickey.
- STEP 3:** Determine fixture height. Make adjustment if needed. Attach chain to fixture loop using open-able chain.
- STEP 4:** Pass the collar loop ring and canopy, over the chain.
- STEP 4.1:** Hook the open-able of the chain to collar loop.
- STEP 5:** Lace the wires through the chain (every other link) Pull ends of wire through center hole of collar loop and out the openings of the cast hickey.
- STEP 6:** Refer to wiring diagram. With wire carefully threaded thru canopy, connect the black supply wire to the smooth fixture wire with wire connector, connect the white supply wire to the ribbed fixture wire with wire connector. Connect ground wire from fixture with supply ground wire.
- STEP 7:** Carefully tuck in all wires and raise the canopy to the outlet box.
- STEP 8:** Secure canopy with collar loop ring.

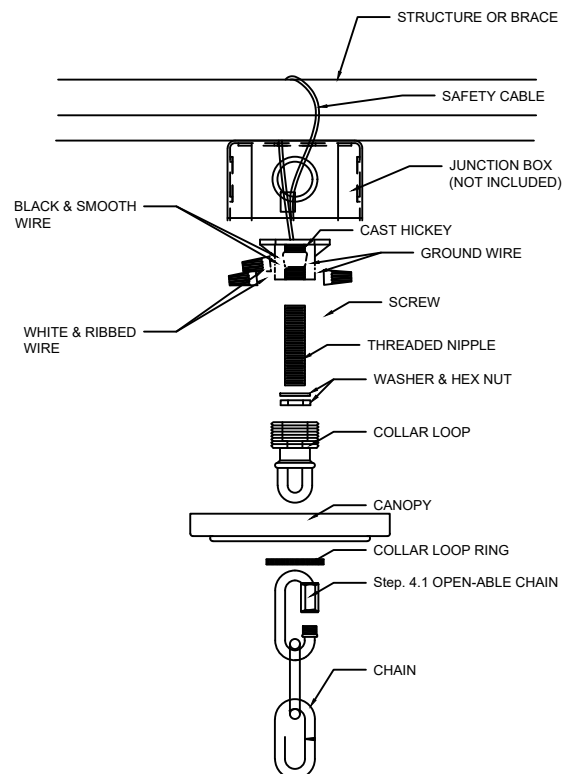



KALCO
Handcrafted Since 1980

ASSEMBLY & INSTALLATION INSTRUCTIONS

MODEL: 506273MGM
STUYVESANT 28 LIGHT 2-TIER CHANDELIER

COMPONENT ASSEMBLY

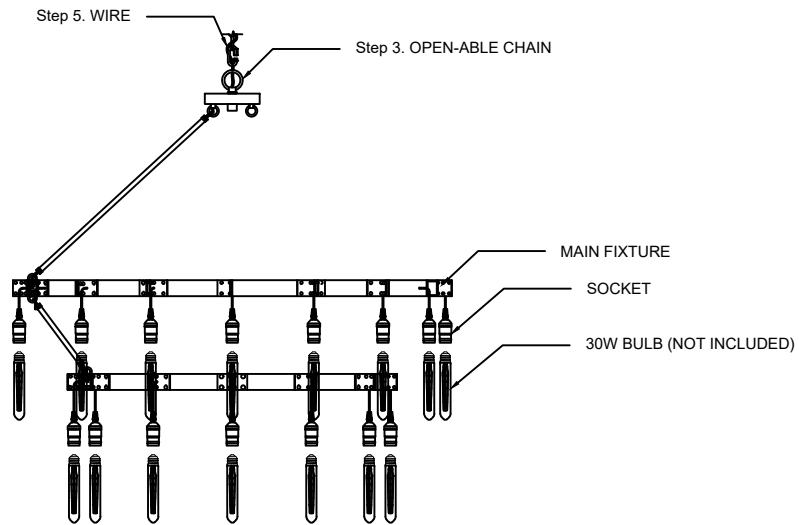

STEP 9: Install the bulb, do not use bulbs that exceed 30 Watts.

FOR LIGHTING MAINTENANCE:

- Regular cleaning of fixture with proper and gentle care using a soft duster, soft lint-free or damp cloth is recommended.
- Refrain from using harsh cleaning liquids that may cause chemical reaction on the hand painted finishes.
- Always refer to the Assembly Instruction before removing any components.
- **HANDLE WITH CARE.**







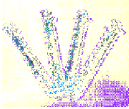
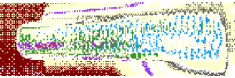

ASSEMBLY & INSTALLATION INSTRUCTIONS

MODEL: 506273MGM
STUYVESANT 28 LIGHT 2-TIER CHANDELIER

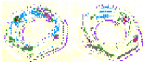
KALCO
Handcrafted Since 1980[®]

PARTS LIST

IMAGE	PARTS NAME	QTY .
	X-14 Parts Bag	1 PC
	Screw	4 PCs
	Threaded Nipple (Short)	1 PC
	Star Washer	2 PCs
	Hex Nut	2 PCs
	Threaded Nipple (Long)	1 PC
	Open-able Chain	2 PCs
	Chain (8ft.)	1 PC
	Canopy	1 PC