

ASSEMBLY & INSTALLATION INSTRUCTIONS

MODEL: 520272
GABARDINE 10LT CHAND 42 IN DIA

I M A G E



If you have any questions or problems assembling your fixture please call us for assistance.

Customer Service: (702) 361-4345 or (800) 525-2655
customer.services@kalco.com

WARNING! TO REDUCE THE RISK OF FIRE OR INJURY PLEASE TAKE PRECAUTION AND FOLLOW THE STEPS BELOW.

1. If you are unfamiliar with electrical wiring, call a qualified electrician to install this unit. More than one person may be necessary to install fixture, make sure you have enough qualified help.
2. Turn off the power to the fixture's circuit at the service panel. Use a voltage detector to verify that the power is off.
3. DO NOT install bulb which exceeds the maximum wattage specified on the socket label.

Si vous avez des questions ou des problèmes assemblage de votre dispositif s'il vous plait appel pour l'assistance.

Customer Service: (702) 361-4345 or (800) 525-2655
customer.services@kalco.com

AVERTISSEMENT! POUR RÉDUIRE LES RISQUES D'INCENDIE OU DE BLESSURES S'IL VOUS PLAÎT PRENDRE DES PRÉCAUTIONS ET SUIVEZ LES ÉTAPES CI-DESSOUS.

1. Si vous n'êtes pas familier avec le câblage électrique, appelez un électricien qualifié pour installer cet appareil. Plus d'une personne peut être nécessaire d'installer appareil, assurez vous que vous disposez de l'aide assez qualifié.
2. Coupez l'alimentation au circuit de l'appareil sur le tableau de service. Utiliser un détecteur de tension pour vérifier que l'alimentation est coupée
3. NE PAS installer l'ampoule qui excède la puissance maximale indiquée sur l'étiquette du socket.

WIRING DIAGRAM

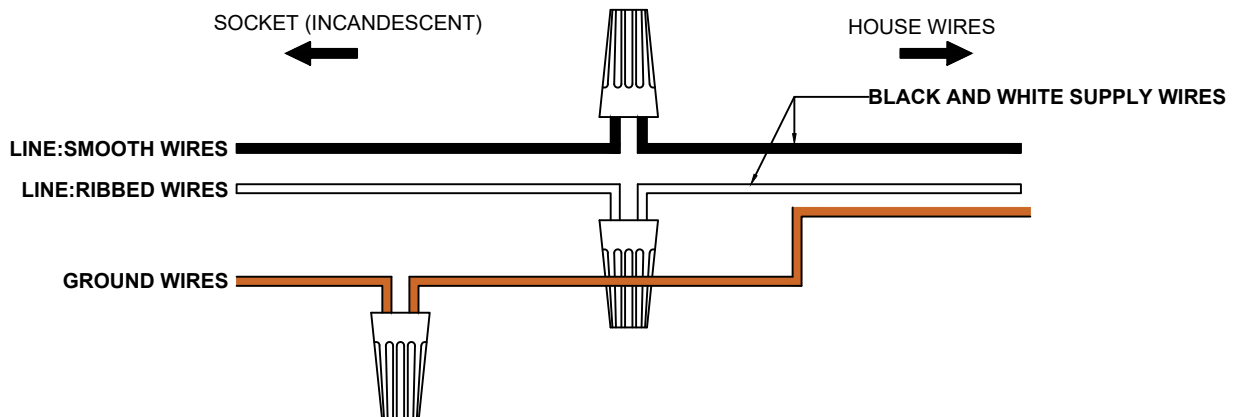

ASSEMBLY & INSTALLATION INSTRUCTIONS

MODEL: 520272
GABARDINE 10LT CHAND 42 IN DIA

COMPONENTS ASSEMBLY

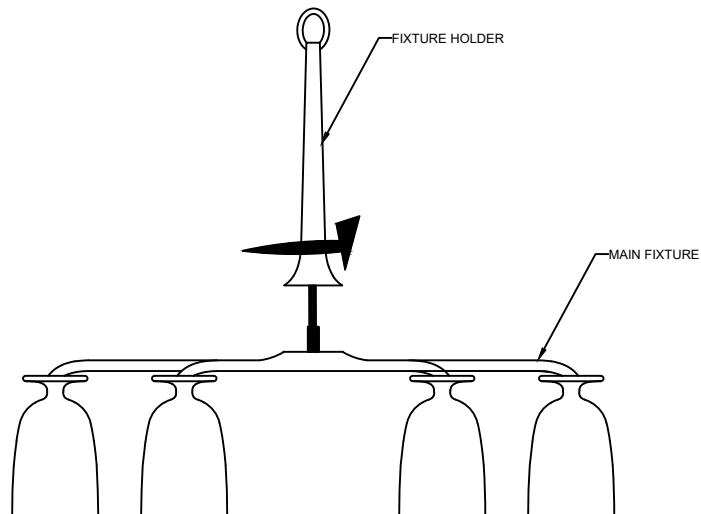

STEP 1: Attached the fixture holder to the main fixture

LIGHTING MAINTENANCE:

- Regular cleaning of fixture with proper and gentle care using a soft duster, soft lint-free or damp cloth is recommended.
- Refrain from using harsh cleaning liquids that may cause chemical reaction on the hand painted finishes.
- Always refer to the Assembly Instruction before removing any components.
- **HANDLE WITH CARE.**

ASSEMBLY & INSTALLATION INSTRUCTIONS

MODEL: 520272
GABARDINE 10LT CHAND 42 IN DIA

ELECTRICAL / MOUNTING INSTALLATION

STEP 2: Fasten nipple into mounting plate so that they extend away from the ceiling when the mounting plate is installed. Lock in place using the hex nut & washer provided.

STEP 3: Attach mounting plate to outlet box with the (2) 8-32 x 3/4" screws (provided by other).

STEP 4: Determine fixture height. Make adjustment if needed. Attach chain to fixture hook and canopy loop using open-able chain link.

STEP 5: Lace wires through the chain links (every other link).

STEP 6: Refer to wiring diagram. With wire carefully threaded thru canopy, connect the black supply wire to the smooth fixture wire with wire connector, connect the white supply wire to the ribbed fixture wire with wire connector. Connect ground wire from fixture with supply ground wire.

STEP 7: Carefully tuck all wires into outlet box ensuring that there are no wires pinched between the canopy and ceiling.

STEP 8: Lock in place the canopy using the collar loop ring.

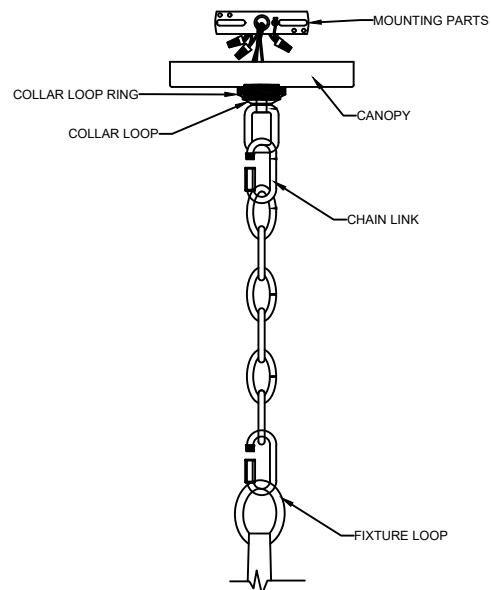
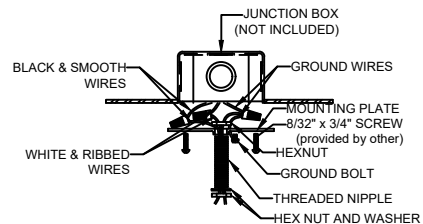



KALCO
Handcrafted Since 1980™

ASSEMBLY & INSTALLATION INSTRUCTIONS

MODEL: 520272
GABARDINE 10LT CHAND 42 IN DIA

COMPONENTS ASSEMBLY

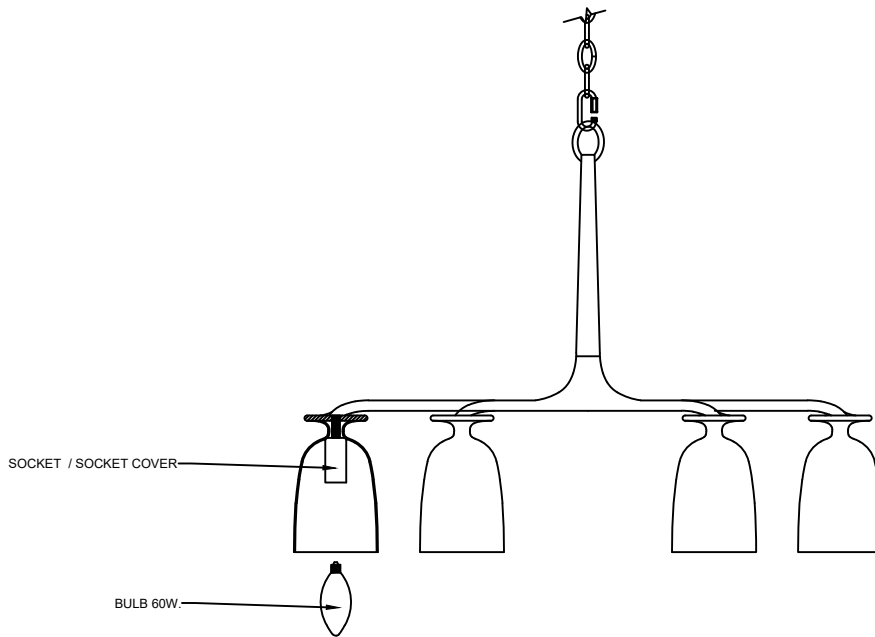

STEP 9: Insert bulbs. Do not put bulb that exceeds 40watts.

LIGHTING MAINTENANCE:

- Regular cleaning of fixture with proper and gentle care using a soft duster, soft lint-free or damp cloth is recommended.
- Refrain from using harsh cleaning liquids that may cause chemical reaction on the hand painted finishes.
- Always refer to the Assembly Instruction before removing any components.
- **HANDLE WITH CARE.**





KALCO
Handcrafted Since 1980™

ASSEMBLY & INSTALLATION INSTRUCTIONS

MODEL: 520272
GABARDINE 10LT CHAND 42 IN DIA

PARTS LIST

IMAGE	PARTS NAME	QTY
	X-9 Parts Bag	1 PC
	Threaded Nipple	1 PC
	Star Washer	1 PC
	Hex Nut	2 PCS
	Open-able Chain	2 PCS
	Chain (8ft.)	1 PC
	Canopy	1 PC