



KALCO.
Handcrafted Since 1980

ASSEMBLY & INSTALLATION INSTRUCTIONS

MODEL: 522866BGL
6 LIGHTS ISLAND LIGHT

I M A G E

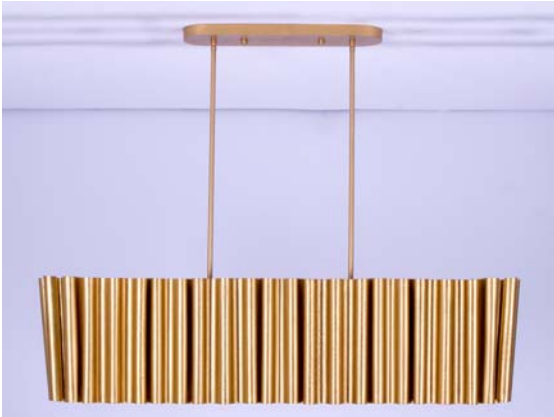

If you have any questions or problems assembling your fixture please call us for assistance.

Customer Service: (702) 361-4345 or (800) 525-2655
customer.services@kalco.com

WARNING! TO REDUCE THE RISK OF FIRE OR INJURY PLEASE TAKE PRECAUTION AND FOLLOW THE STEPS BELOW.

1. If you are unfamiliar with electrical wiring, call a qualified electrician to install this unit. More than one person may be necessary to install fixture, make sure you have enough qualified help.
2. Turn off the power to the fixture's circuit at the service panel. Use a voltage detector to verify that the power is off.
3. DO NOT install bulb which exceeds the maximum wattage specified on the socket label.

Si vous avez des questions ou des problèmes assemblage de votre dispositif s'il vous plait appel pour l'assistance.

Customer Service: (702) 361-4345 or (800) 525-2655
customer.services@kalco.com

AVERTISSEMENT! POUR RÉDUIRE LES RISQUES D'INCENDIE OU DE BLESSURES S'IL VOUS PLAÎT PRENDRE DES PRÉCAUTIONS ET SUIVEZ LES ÉTAPES CI-DESSOUS.

1. Si vous n'êtes pas familier avec le câblage électrique, appelez un électricien qualifié pour installer cet appareil. Plus d'une personne peut être nécessaire d'installer appareil, assurez vous que vous disposez de l'aide assez qualifié.
2. Coupez l'alimentation au circuit de l'appareil sur le tableau de service. Utiliser un détecteur de tension pour vérifier que l'alimentation est coupée
3. NE PAS installer l'ampoule qui excède la puissance maximale indiquée sur l'étiquette du socket.

WIRING DIAGRAM

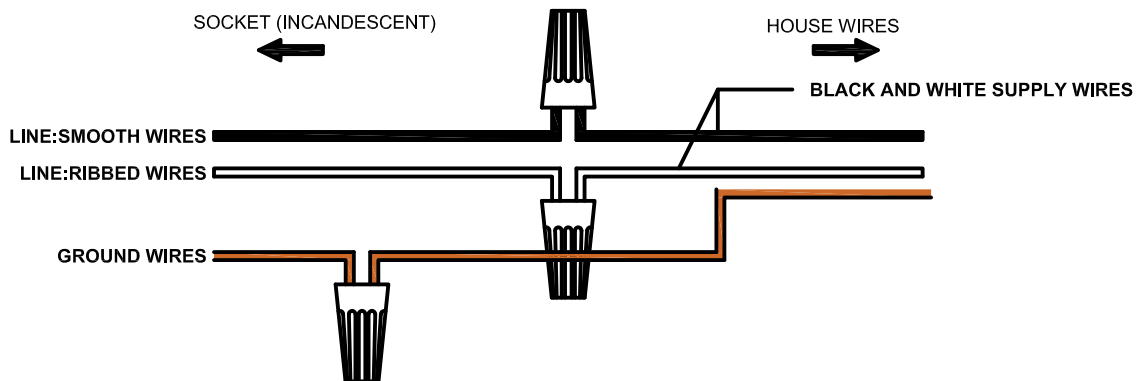



KALCO
Handcrafted Since 1980

ASSEMBLY & INSTALLATION INSTRUCTIONS

MODEL: 522866BGL
6 LIGHTS ISLAND LIGHT

KNOCK DOWN ASSEMBLY

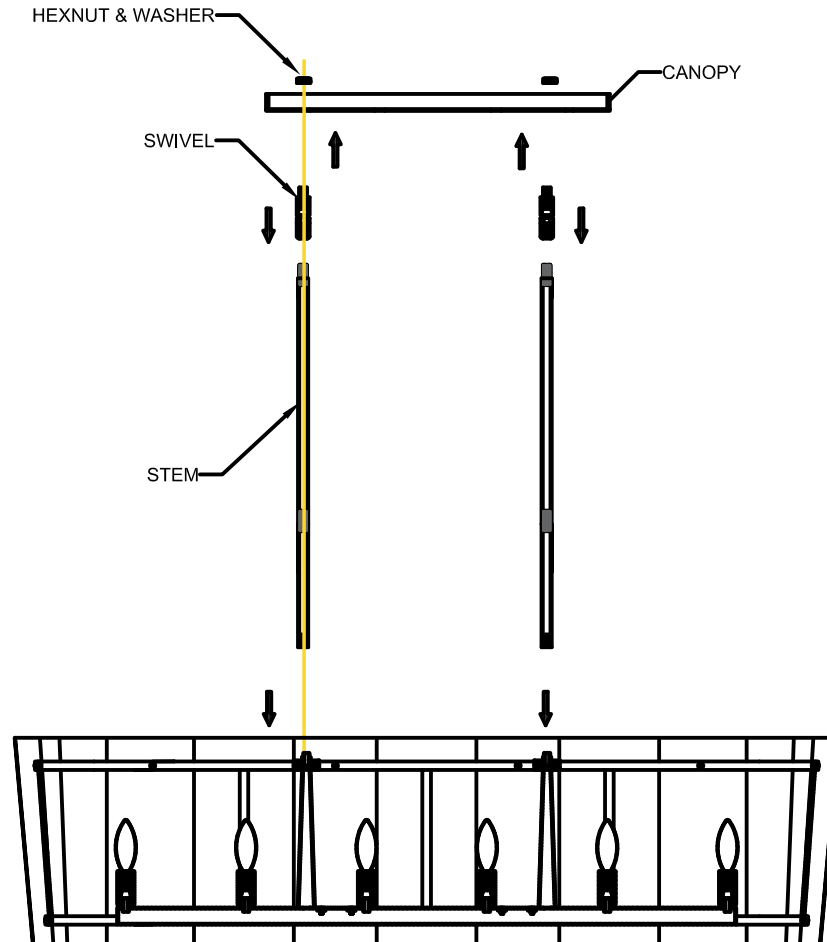

NOTE:

Shade may come pre-assembled to the main frame. To detach the shade unthread the screw

LIGHTING MAINTENANCE:

- Regular cleaning of fixture with proper and gentle care using a soft duster, soft lint-free or damp cloth is recommended.
- Refrain from using harsh cleaning liquids that may cause chemical reaction on the hand painted finishes.
- Always refer to the Assembly Instruction before removing any components.
- **HANDLE WITH CARE.**



KALCO
Handcrafted Since 1980

ASSEMBLY & INSTALLATION INSTRUCTIONS

MODEL: 522866BGL
6 LIGHTS ISLAND LIGHT

ELECTRICAL / MOUNTING INSTALLATION

STEP 1: Carefully insert the wire through the first stem and attach the stem to the main frame as shown.

STEP 2: Determine the required height and adjust the stems accordingly. Attach the swivel at the top end of the stem, affix the canopy with hexnut.

STEP 3: Fasten (2) 8-32 x 1 1/2" studs into mounting plate so that they extend away from the ceiling when the mounting plate is installed.

STEP 4: Attach mounting plate to outlet box with the (2) 8-32 x 3/4" screws(provided by other).

STEP 5: Connect bare ground wire from the outlet box (if supplied) with connectors.

STEP 6: Refer to wiring diagram. With wire carefully threaded thru the swivel, connect the black supply wire to the black fixture wire with wire connector, connect the white supply wire to the white fixture wire with wire connector.

STEP 7: Carefully tuck all wires into outlet box ensuring that there are no wires pinched between the canopy and ceiling.

STEP 8: Cap the canopy to the mounting plate, make sure that it rest firmly on the ceiling then lock using the swivel ring.

STEP 9: Insert bulbs. Do not put bulb that exceeds 60watts.

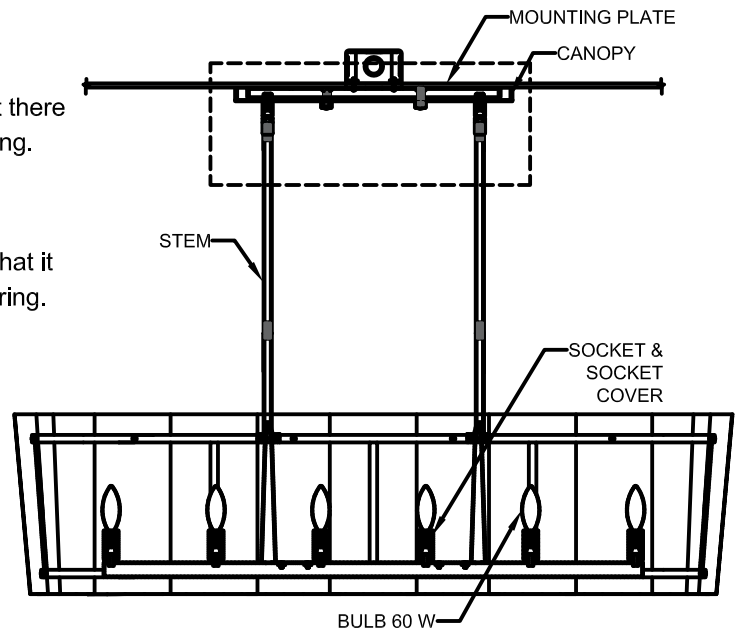
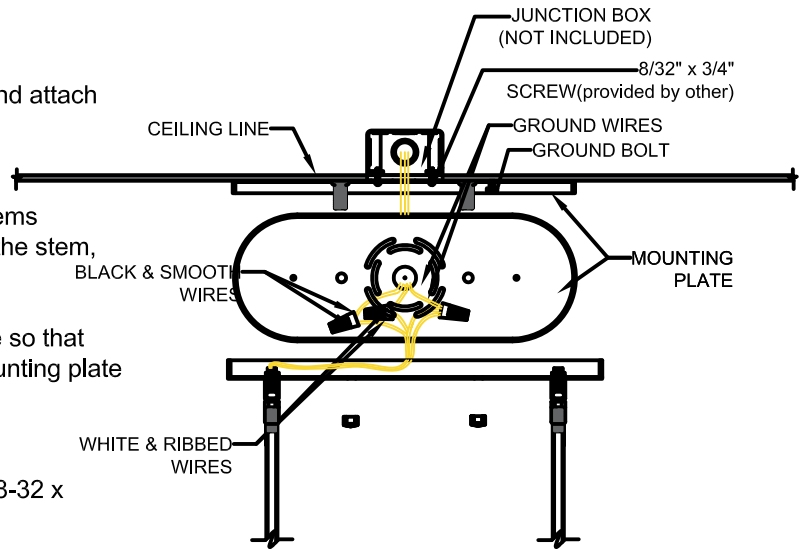







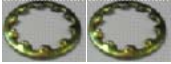

KALCO
Handcrafted Since 1980

ASSEMBLY & INSTALLATION INSTRUCTIONS

MODEL: 522866BGL
6 LIGHTS ISLAND LIGHT

PARTS LIST

IMAGE	PARTS NAME	QTY
	Modified Mounting Plate	1 PC
	Star Washer	2 PC
	Hex Nut	2 PCS
	Canopy	1 PC
	RS cap	2 PC
	STEM	2 SETS
	SWIVEL	2 PCS