



ASSEMBLY & INSTALLATION INSTRUCTIONS

MODEL: 523157OL
39" DIAMETER 2 TIER PENDANT

I M A G E

If you have any questions or problems assembling your fixture please call us for assistance.

Customer Service: (702) 361-4345 or (800) 525-2655

customer.services@kalco.com

WARNING! TO REDUCE THE RISK OF FIRE OR INJURY PLEASE TAKE PRECAUTION AND FOLLOW THE STEPS BELOW.

1. If you are unfamiliar with electrical wiring, call a qualified electrician to install this unit. More than one person may be necessary to install fixture, make sure you have enough qualified help.
2. Turn off the power to the fixture's circuit at the service panel. Use a voltage detector to verify that the power is off.
3. DO NOT install bulb which exceeds the maximum wattage specified on the socket label.

Si vous avez des questions ou des problèmes assemblage de votre dispositif s'il vous plait appel pour l'assistance.

Customer Service: (702) 361-4345 or (800) 525-2655

customer.services@kalco.com

AVERTISSEMENT! POUR RÉDUIRE LES RISQUES D'INCENDIE OU DE BLESSURES S'IL VOUS PLAÎT PRENDRE DES PRÉCAUTIONS ET SUIVEZ LES ÉTAPES CI-DESSOUS.

1. Si vous n'êtes pas familier avec le câblage électrique, appelez un électricien qualifié pour installer cet appareil. Plus d'une personne peut être nécessaire d'installer appareil, assurez vous que vous disposez de l'aide assez qualifié.
2. Coupez l'alimentation au circuit de l'appareil sur le tableau de service. Utiliser un détecteur de tension pour vérifier que l'alimentation est coupée
3. NE PAS installer l'ampoule qui excède la puissance maximale indiquée sur l'étiquette du socket.



WIRING DIAGRAM

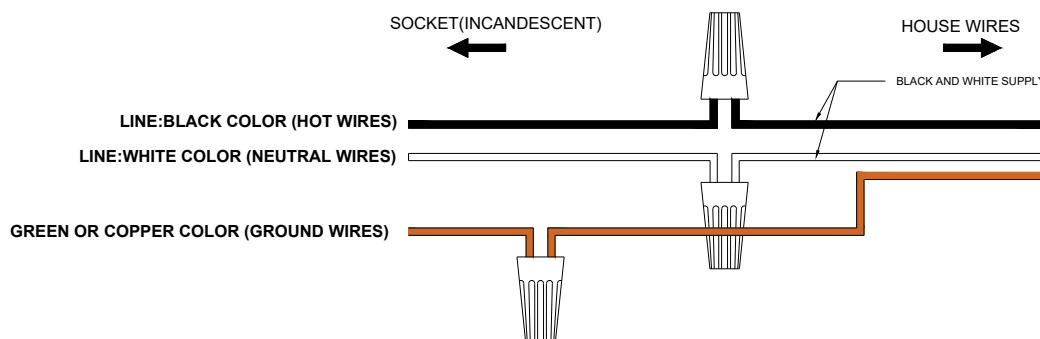

ASSEMBLY & INSTALLATION INSTRUCTIONS

MODEL: 523157OL
39" DIAMETER 2 TIER PENDANT

KNOCK DOWN ASSEMBLY

STEP 1: Carefully insert the wire through the center column.

STEP 2: Connect the top and bottom frame of wire by clipping the wire connector attached on the both wire end.

Note: Carefully bend the wire to have a good clearance for wire connector to go inside the center column.

Do not pull the wire of the bottom frame to prevent to much exposed of wire.

STEP 3: Align the center column to the 1st tier and 2nd tier shade cluster then secure it with 1/4 IN. flat head bolt (4PCS).

Note: It's recommend to assemble the top frame first for better installation.

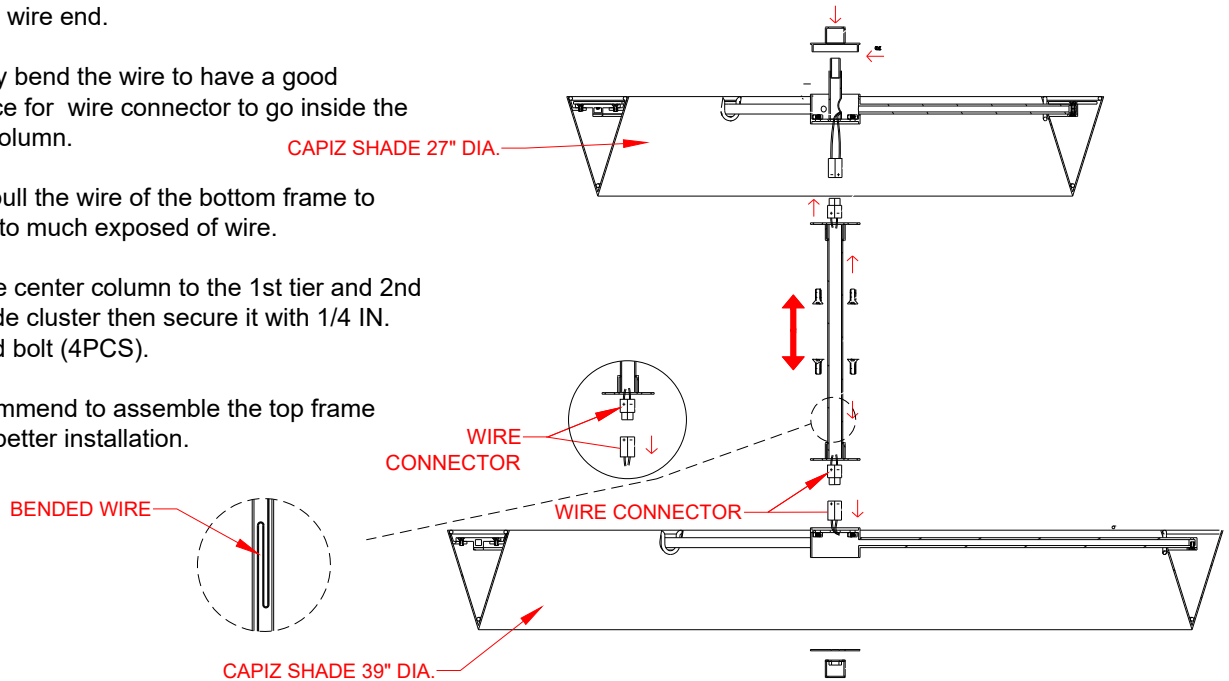

ELECTRICAL / MOUNTING INSTALLATION

STEP 4: Attach mounting plate to outlet box with the (2) 8-32 x 3/4" screws(provided by other).

STEP 5: Connect bare ground wire from the outlet box (if supplied) with connectors.

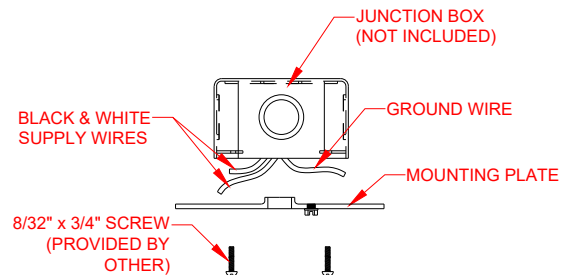

ASSEMBLY & INSTALLATION INSTRUCTIONS

MODEL: 523157OL
39" DIAMETER 2 TIER PENDANT

ELECTRICAL / MOUNTING INSTALLATION

STEP 6: Refer to wiring diagram, insert wire carefully threaded through the swivel, connect LED wire to the LED driver.

STEP 7: Refer to wiring diagram, connect the black color supply wire to the black color led driver wire with wire connector, connect the white color supply wire to the white led driver wire with wire connector.

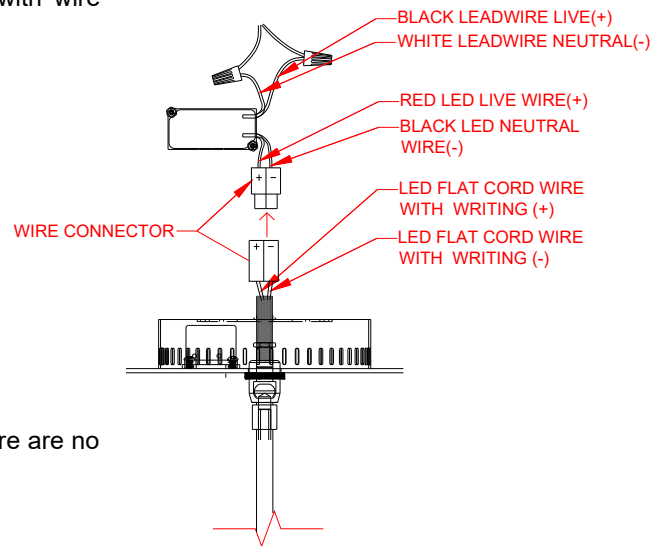
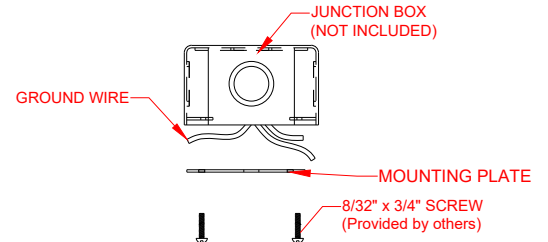
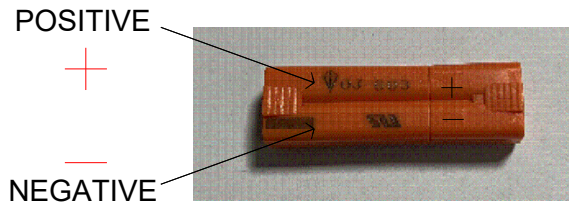

STEP 8: Carefully tuck all wires into outlet box ensuring that there are no wires pinched between the canopy and ceiling.

STEP 9: Cap the canopy to the mounting plate, make sure that it rest firmly on the ceiling then lock using the swivel ring.

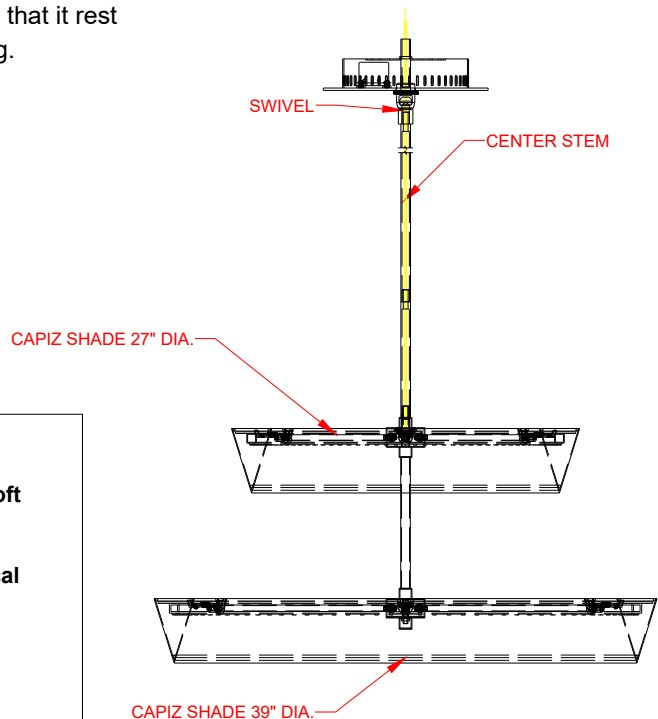

FOR LIGHTING MAINTENANCE:

- Regular cleaning of fixture with proper and gentle care using a soft duster, soft lint-free or damp cloth is recommended.
- Refrain from using harsh cleaning liquids that may cause chemical reaction on the hand painted finishes.
- Always refer to the Assembly Instruction before removing any components.
- **HANDLE WITH CARE.**

ASSEMBLY & INSTALLATION INSTRUCTIONS

MODEL: 523157OL
39" DIAMETER 2 TIER PENDANT

PARTS LIST

| IMAGE | PARTS NAME | QTY |
|---|-----------------|-------|
|  | Mounting Plate | 1 PC |
|  | Hex Nut | 6 PCS |
|  | Star Washer | 1 PC |
|  | Connecting wire | 1PC |
|  | Center Column | 1PC |
|  | Canopy | 1 PC |
|  | Swivel | 1 PC |
|  | Stem | 1 SET |
|  | Threaded Nipple | 1 PC |
|  | Allen wrench | 1 PC |