

ASSEMBLY AND INSTALLATION INSTRUCTIONS

WARNING: TO AVOID RISK OF ELECTRICAL SHOCK, BE SURE TO SHUT OFF POWER PRIOR TO INSTALLING OR SERVICING THIS FIXTURE.

NOTE: Before installing, consult local electrical codes for wiring and grounding requirements.

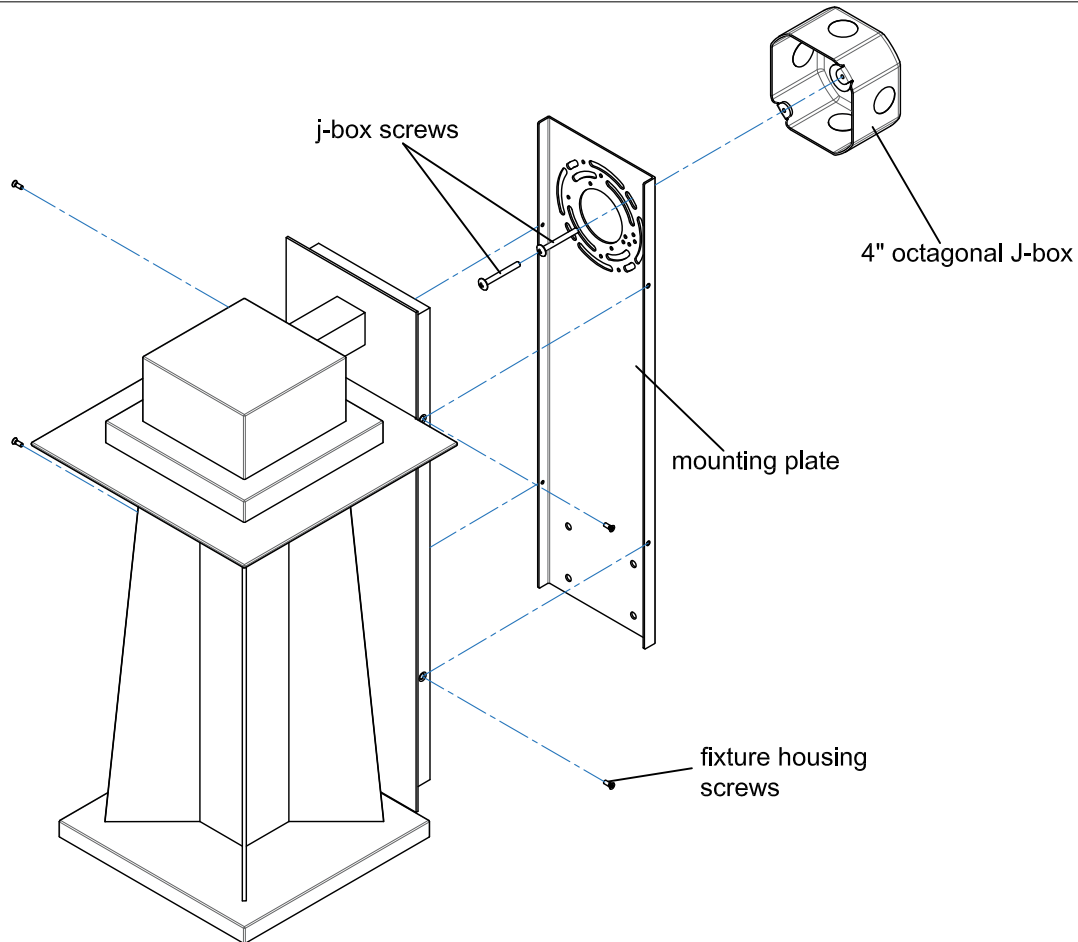

Installation Steps

1. Carefully unpack your new fixture and lay out all the parts on a clean surface. Take care not to lose any small parts necessary for installation. Remove fixture screws to release mounting plate.
2. Install the mounting plate to the j-box with j-box screws. If needed, use the extra mounting holes in the mounting plate to secure it to the building structure.
3. Make wire connections. Refer to driver label for wire identification. Attach ground wire to building ground wire using a wire nut.
 - **FOR DIMMING:** If using a dimmer (not included), follow wiring instructions enclosed with dimmer. Double check wiring. Tuck the wire connections neatly into the junction box.
 - **FOR NON-DIMMING:** If not using a dimming switch, with wire nuts, cap off purple and gray wires individually. Connect neutral wire (white) with neutral wire, hot wire (black) with hot wire. Double check wiring.
4. Carefully tuck wire connections neatly into the junction box. Install the mounting plate to the j-box.
5. Install fixture body to mounting plate and secure it with fixture screws. Fixture should be secure against wall.
6. Caulk around the top, bottom and sides of the back plate to avoid water ingress with suitable RTV or silicone compound.
7. Turn power back on at fuse or circuit box.

ARTÉ outdoor
3-760-xx

OXYGEN LIGHTING ©

oxygen

OXYGEN LIGHTING
201 RAILHEAD RD, FORT WORTH, TX 76106
TEL. (877) 607-0202 FAX (877) 607-0203
WWW.OXYGENLIGHTING.COM

ASSEMBLY INSTRUCTIONS