

ASSEMBLY AND INSTALLATION INSTRUCTIONS

WARNING: TO AVOID RISK OF ELECTRICAL SHOCK, BE SURE TO SHUT OFF POWER PRIOR TO INSTALLING OR SERVICING THIS FIXTURE.

NOTE: Before installing, consult local electrical codes for wiring and grounding requirements.

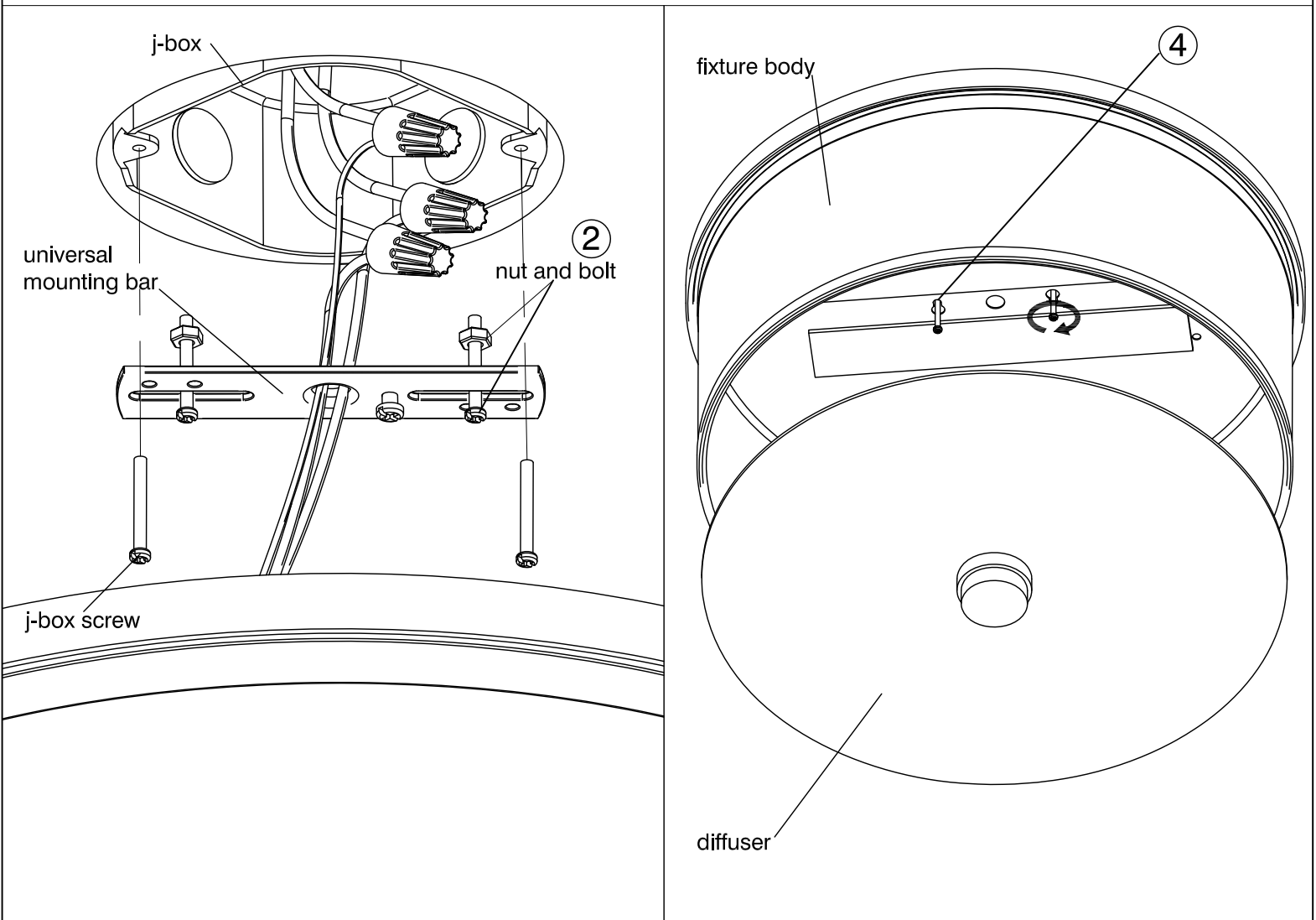

Installation Steps

1. Carefully unpack your new fixture and lay out all the parts on a clean surface. Take care not to lose any small parts necessary for installation.
2. Install a nut and bolt to each slot of the universal mounting bar loose like shown. Install mounting bar to j-box securely.
3. Make wire connections: Attach ground wire to building ground wire using a wire nut or attach them to the mounting plate with a green ground screw.
 - **FOR DIMMING:** If using a dimmer, follow wiring instructions enclosed with dimmer. Double check wiring.
 - **FOR NON-DIMMING:** If not using a dimming switch, with wire nuts, cap off purple and gray wires individually. Wire positive wire with positive wire, negative wire with negative wire. Double check wiring.
4. Install fixture body to mounting bar by guiding fixture key slot holes over the two screws from step two. Turn the fixture to lock in the screw heads to keep the fixture from falling while the screws are tightened. Tighten screws until the fixture is secure against the ceiling and cannot be turned easily.
5. Install diffuser by inserting it at an angle into the fixture until it is completely inside. Carefully lower the diffuser until it sits flat and level against inside the lower ring.
6. Turn power back on at fuse or circuit box.

ECHO Sconce
120v **3-695-xx**
277v **37-695-xx**

OXYGEN LIGHTING ©

oxygen

OXYGEN LIGHTING
201 RAILHEAD RD, FORT WORTH, TX 76106
TEL. (877) 607-0202 FAX (877) 607-0203
WWW.OXYGENLIGHTING.COM

ASSEMBLY INSTRUCTIONS