

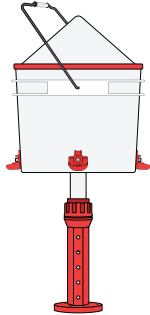

USER MANUAL

Bucket Stand Waterer

5-Gallon | 10-Gallon
Center and Corner Models



2-Gallon [center model]

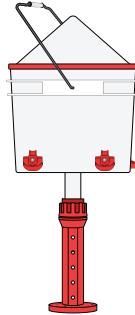

2-Gallon [corner model]

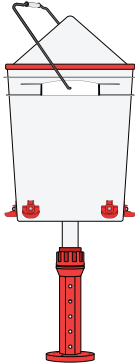

5-Gallon [center model]

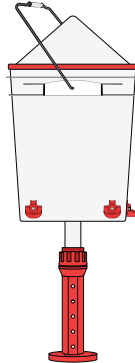

5-Gallon [corner model]

WR-2GAL-CNTR
8F-815H-2MS3
PL-2GAL-SET









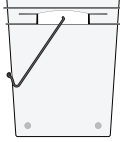
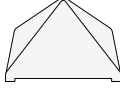

F1-JFX1-I7Y55
GL-NPWT-CRNR
PL-FDWA-CNTR

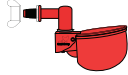
TABLE OF CONTENTS

Package Contents	3
Waterer Height & Drinker Attachment Information	4
Adjustable Bucket Stand Parts	6
How to Assemble Bucket Stand	7-8
Waterer Parts	9
How to Assemble Waterer	10-13
Maintenance	14
How to Clean Auto-Fill Cup	14-15
Contact Information	BACK COVER

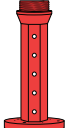
NOTE: *These instructions are the same for both 2-Gallon and 5-Gallon buckets, even if the product shown differs slightly from your model.*

PACKAGE CONTENTS

	1x Bucket Waterer
	1x Anti-Roost Cone
	1x Waterer Lid with Cap Plug
	4x Auto-Fill Cups* <i>*The 5-Gallon [center model only] Waterer comes with 6x Auto-Fill Cups</i>
	4x Horizontal Nipples with Dribble Dishes <i>*The 5-Gallon [center model only] Waterer comes with 6x Horizontal Nipples</i>
	1x Locking Nut
	1x Post End Seal
	1x Post
	1x Adjustable Stand Base
	4x Grounding Stakes with Washers
	4x Wood Screws
	1x Magnetic Driver [13mm]

WATERER HEIGHT & DRINKER ATTACHMENT INFORMATION

When introducing a new type of waterer to your animals, completely remove the previous water source and replace it with the new waterer in the same location.

We recommend using only one type of drinking attachment per bucket as chickens will first go for the visible water source.

The position of the drinker depends on the height of your animal. We do not provide an exact measurement as all animal sizes vary. Please use your best judgement.

Auto-Fill Cup with Removable Cup Inserts

The Auto-Fill Cup can be used with chickens at any age.

BENEFITS

- Perfect for use in warm weather and non-freezing temperatures
- Chickens can dip their wattles in the cups to cool off on hot days
- Suitable for cross-beaks
- Water is visible to chickens
- Requires absolutely no training

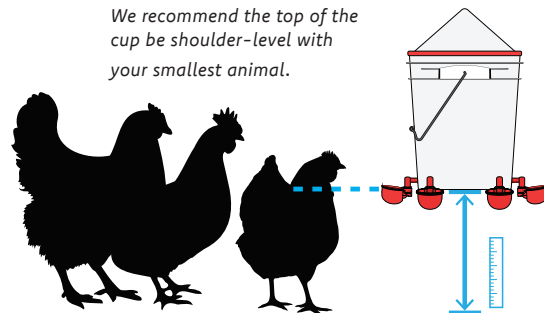

4

Horizontal Nipple with Dribble Dish

Horizontal Nipple is intended for chicks seven days and older.

BENEFITS

- Perfect for use in freezing temperatures when paired with **RentACoop's Thermo Bucket Belt**. *Heating source not included and is sold separately. For safety, please follow the directions that come with your heating source/waterer deicer
- Low-maintenance — no dirty water bowls to clean
- Training your chickens to use the nipples is easy
- *TIP FOR WINTER-USE: We recommend removing the Dribble Dish from horizontal nipple so that water doesn't pool and freeze in it. The dribble dish snaps on and off.*

TRAINING

Mimic pecking by tapping on the nipple multiple times in front of your chickens so that they can see where to get the water.

Leave a drop of water on the protruding ledge of the horizontal nipple for your chickens to notice!

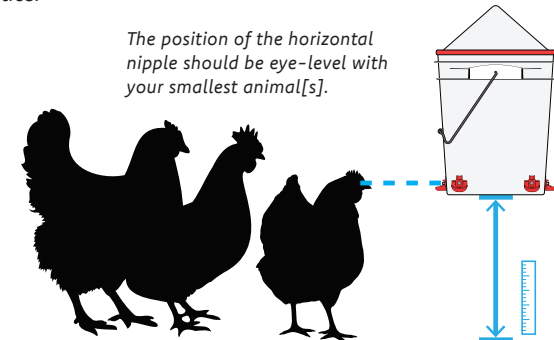

5

ADJUSTABLE BUCKET STAND PARTS

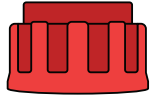

1x Locking Nut



1x Post End Seal



1x Post

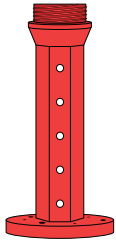

1x Adjustable Stand Base



4x Grounding Stakes with Washers



4x Wood Screws



1x Magnetic Driver [13mm]

HOW TO ASSEMBLE ADJUSTABLE BUCKET STAND

1. Determine waterer placement and anchor adjustable stand base into the desired foundation.

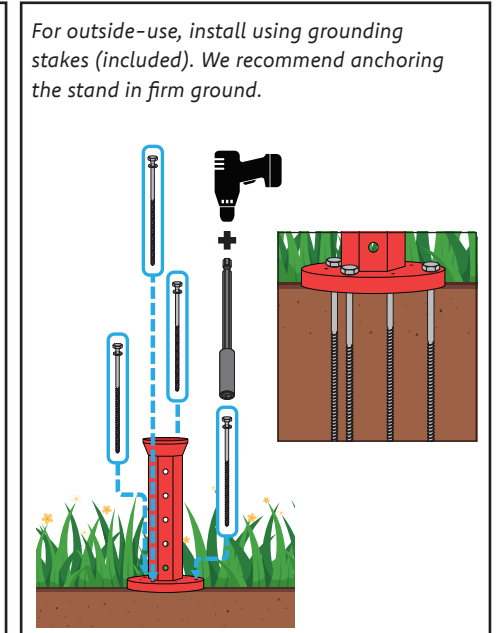
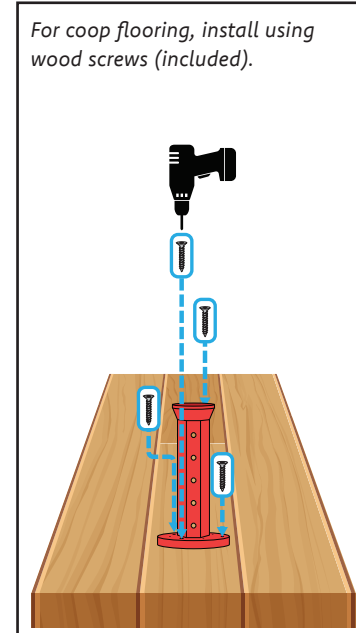

2. Slide post end seal onto post. The position of the seal determines how low or high you want waterer to sit. Adjust accordingly.

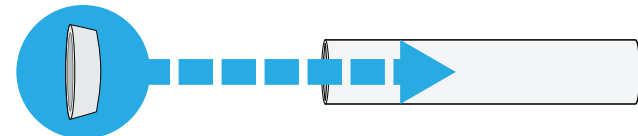

3. Insert post with seal into base stand and adjust to desirable height. Move the seal up to have the waterer positioned lower or move the seal down to have the waterer positioned higher. See pages 4 and 5 for waterer height information.

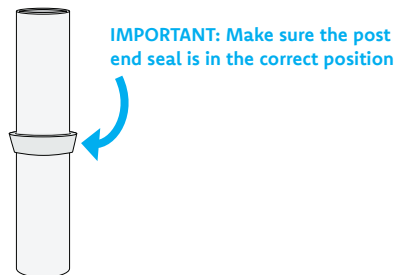

4. Twist locking nut onto post.

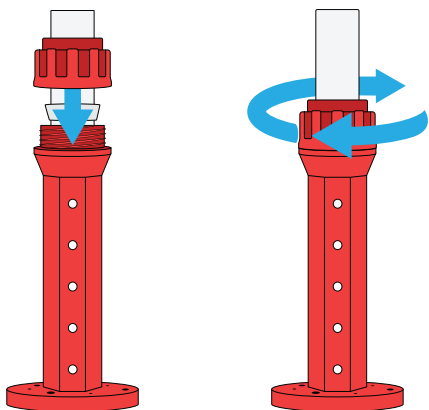

WATERER PARTS

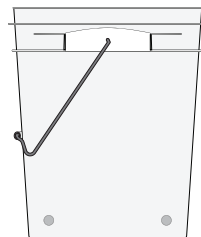

1x Bucket Waterer

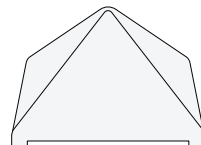

1x Anti-Roost Cone



1x Waterer Lid with Cap Plug

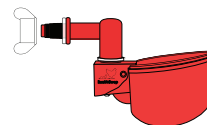

4x Auto-Fill Cups and wingnuts*

*The 5-Gallon **[center model only]** Waterer comes with 6x Auto-Fill Cups

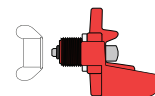

4x Horizontal Nipples with Dribble Dishes

*The 5-Gallon **[center model only]** Waterer comes with 6x Horizontal Nipples

HOW TO ASSEMBLE WATERER

1. Install horizontal nipples OR auto-fill cups.

IMPORTANT: Make sure the gasket stays on the outside of the bucket.

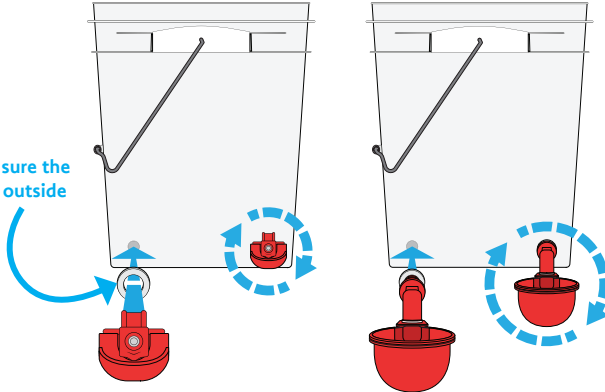

2. Secure the wingnut onto the threads of the drinking attachments from the inside of the bucket and twist until tight.

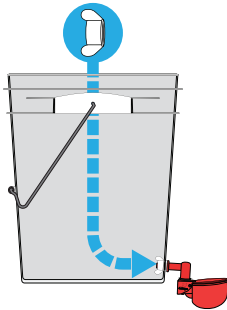

3. Place the bucket onto the adjustable stand and align the inner post with the circular guide molded into the bottom of the bucket. Apply weight and push down the bucket onto the post to secure.

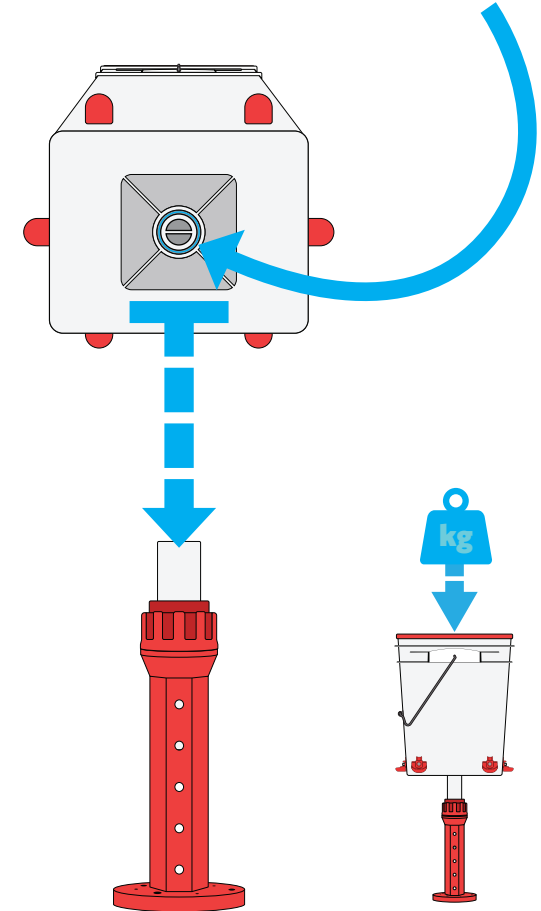

4. Cover with waterer lid and press firmly to secure.

Remove cap plug and fill with water. Replace cap plug and place anti-roost cone on top.

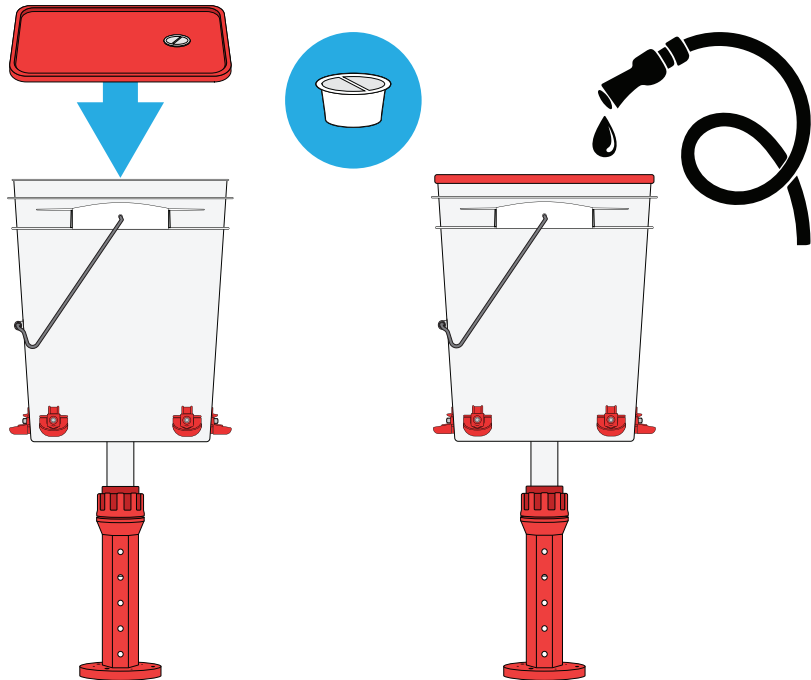

5. Place anti-roost cone on top.

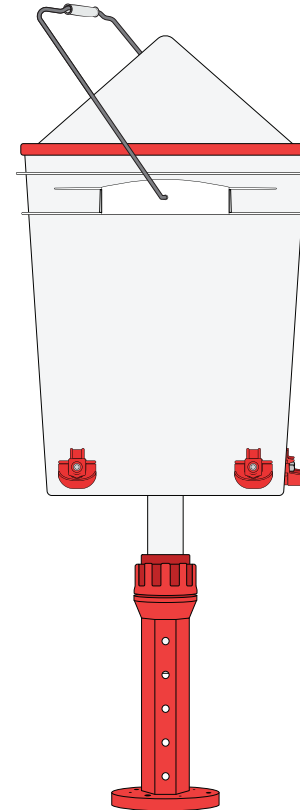

MAINTENANCE

- **Check water level daily** and refill with clean, fresh water.
- **Clean the bucket regularly** to prevent algae, bacteria, and debris buildup.
- **Wash using warm water and mild dish soap**, then rinse thoroughly before refilling.
- **Do not use bleach, harsh chemicals, or abrasive cleaners**, as they may damage the bucket and leave residues harmful to poultry.
- **Inspect the bucket, post, and adjustable stand** for proper alignment, stability, cracks, or wear.
- **Disassemble and deep clean periodically**, especially during warm weather or heavy use.

HOW TO CLEAN AUTO-FILL CUP

1. Clean and wipe any dirt or debris from the cup.

2. Pry one side of the tabs on the base to release the small plastic nodule out of its tab. Be careful not to break the nodule off.

There is a load-spring so make sure to take the base off slowly. Once you release the first nodule, the second tab will come off easy.

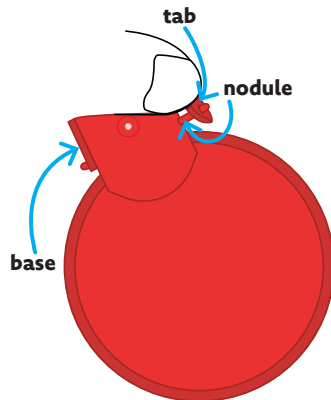

3. Check that all **water spouts** are clean of debris.

You can use a toothpick if clogged.

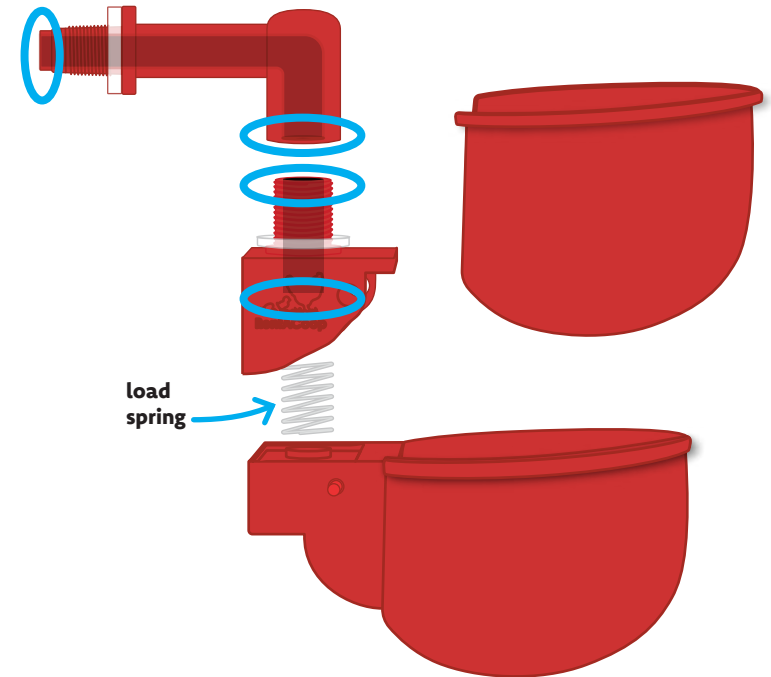



RentACoop®

QUESTIONS?

CONTACT OUR
E G G - S P E R T S

info@rentacoop.com

1 800-642-3571

M-F 9-5 EST



@rentacoop
#rentacoop