

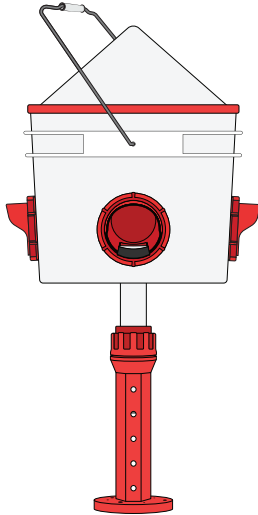

USER MANUAL

Bucket Stand Feeder

10LB | 20LB-Capacity



10LB-Capacity

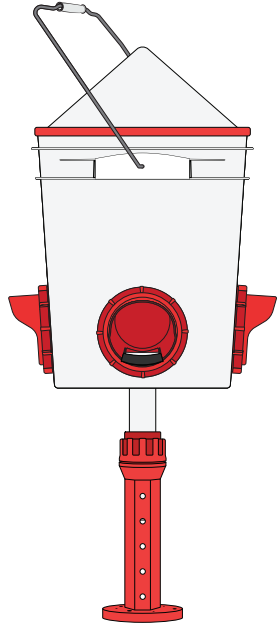









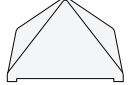

20LB-Capacity

TABLE OF CONTENTS

Package Contents	3
Adjustable Bucket Stand Parts	4-5
How to Assemble Adjustable Bucket Stand	6
Feed-Port Information	7
Feeder Parts	8
How to Assemble Feeder	9-11
Contact Information	BACK COVER

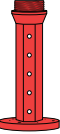
NOTE: *These instructions are the same for both 10LB and 20LB-capacity buckets, even if the product shown differs slightly from your model.*

PACKAGE CONTENTS

	1x Bucket Feeder
	1x Anti-Roost Cone
	1x Feeder Lid
	4x Feed Port Locking Nuts
	4x Feed Ports with gasket
	1x Locking Nut
	1x Post End Seal
	1x Post
	1x Adjustable Stand Base
	4x Grounding Stakes with Washers
	4x Wood Screws
	1x Magnetic Driver [13mm]

ADJUSTABLE BUCKET STAND PARTS

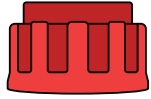

1x Locking Nut



1x Post End Seal



1x Post

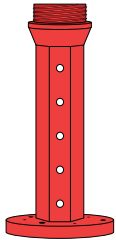

1x Adjustable Stand Base



4x Grounding Stakes with Washers



4x Wood Screws



1x Magnetic Driver [13mm]

HOW TO ASSEMBLE ADJUSTABLE BUCKET STAND

1. Determine feeder placement and anchor adjustable stand base into the desired foundation.

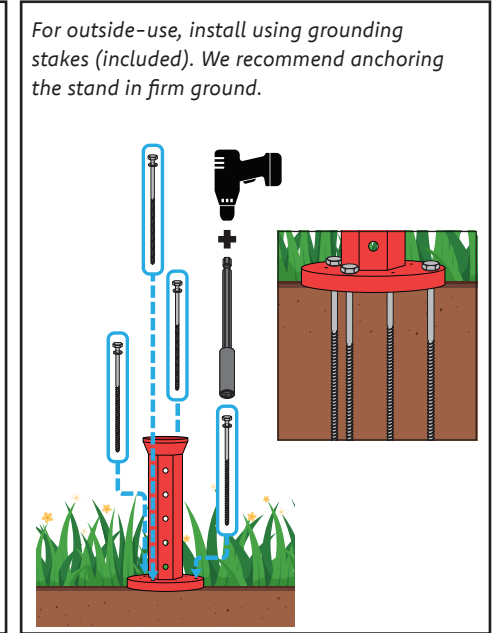
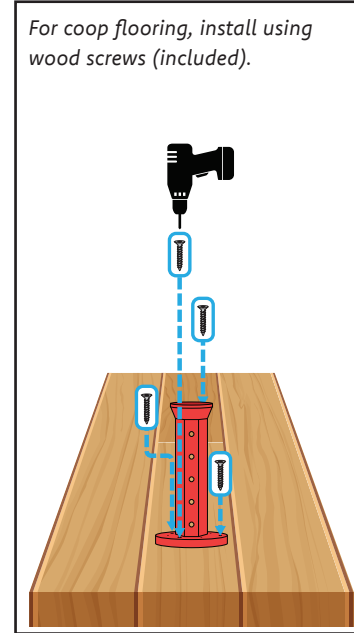

2. Slide post end seal onto post. The position of the seal determines how low or high you want the feeder to sit. Adjust accordingly.

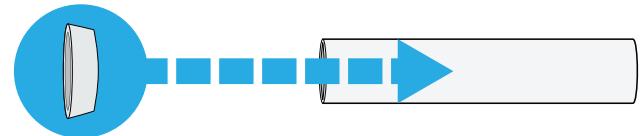

FEED-PORT INFORMATION

3. Insert post with seal into base stand and adjust to desirable height. Move the seal up to have the feeder positioned lower or move the seal down to have the feeder positioned higher. See following page for feeder height information.

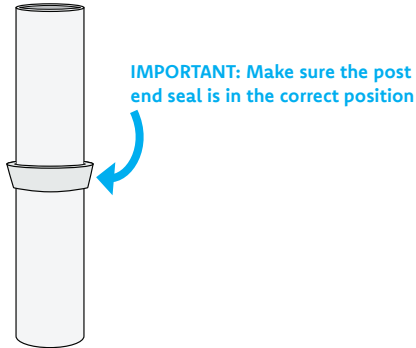

4. Twist locking nut onto post.

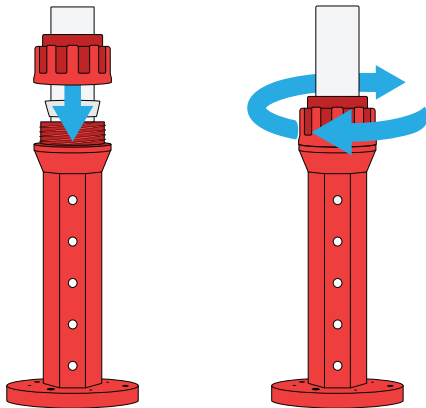

Appropriate feeder height —

For 20LB-capacity Feeders:

The 20LB-capacity buckets come with large feed ports that are appropriate for chickens 12-weeks and older.

The bottom of the port opening should be at shoulder-level of your smallest poultry.

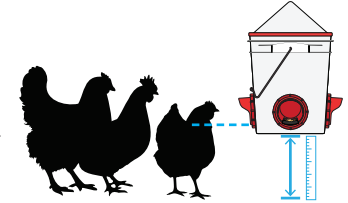

For 10LB-Capacity Feeders:

The 10LB-capacity buckets use the Chick2Chicken ports, a smaller port than the 20L-capacity buckets. These ports are appropriate for chickens three days and older up to adult chickens.

The bottom of the port opening should be at shoulder-level of your smallest chick[en]. For chicks, place feeder directly on the ground and do not use the adjustable stand until they are older.

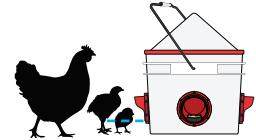

Slide Covers

Keep slide covers in the closed position to restrict access to feed.

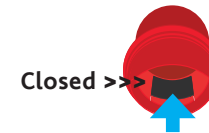

Push the slider into the closed position until it clicks in place to restrict access to feed.

We recommend closing it at night to prevent unwanted guest.

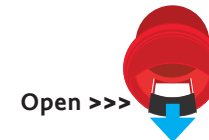

Push the slider into the open position to allow access to feed.

FEEDER PARTS

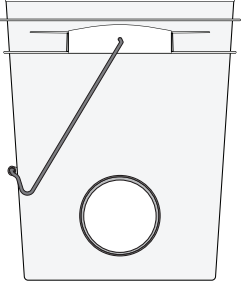

1x Bucket Feeder

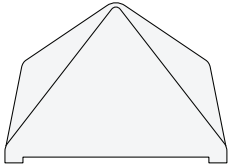

1x Anti-Roost Cone



1x Feeder Lid

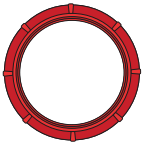

4x Feed Port Locking Nuts

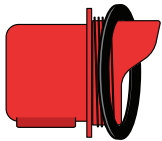

4x Feed Ports with gasket

HOW TO ASSEMBLE FEEDER

1. Place the port inside the bucket and push the front of the port through the pre-cut holes.

IMPORTANT: Make sure the gasket stays on the inside of the bucket.

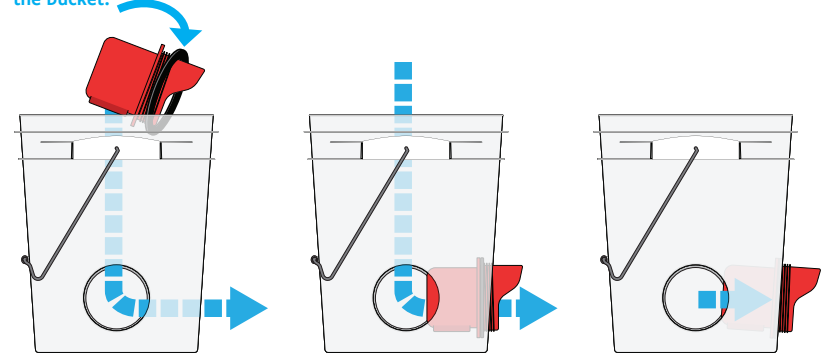

2. Place the locknut around the threads at the base of the rainhood and twist until tight.

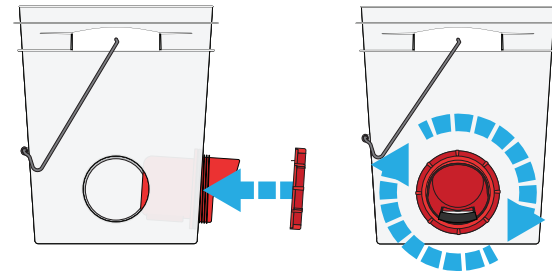

3. Place the bucket onto the adjustable stand and align the inner post with the circular guide molded into the bottom of the bucket. Apply weight and push down the bucket onto the post to secure.

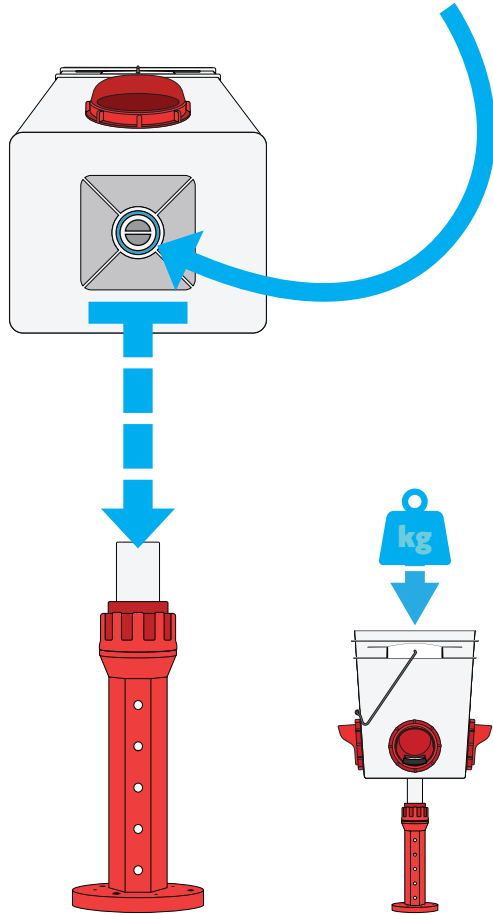

4. Fill with feed and cover with feeder lid. Place anti-roost cone on top.

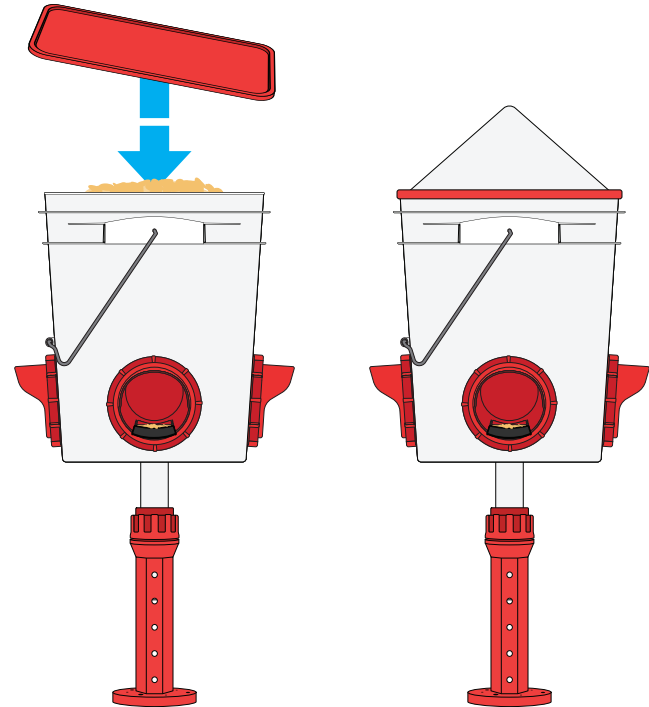



RentACoop®

QUESTIONS?

CONTACT OUR
E G G - S P E R T S

info@rentacoop.com

1 800-642-3571

M-F 9-5 EST



@rentacoop
#rentacoop