

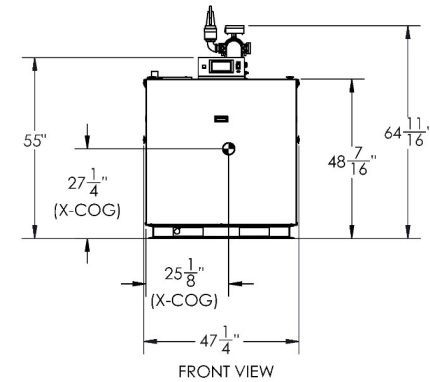

# Water Heater (DHW) SUBMITTAL DATA SHEET

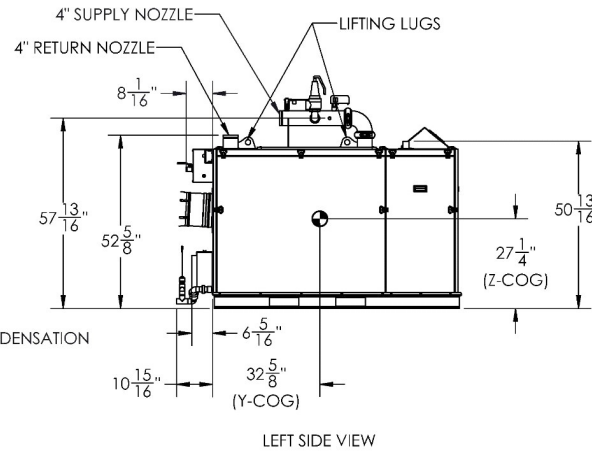
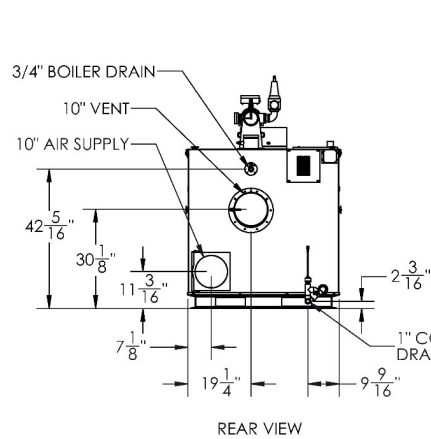
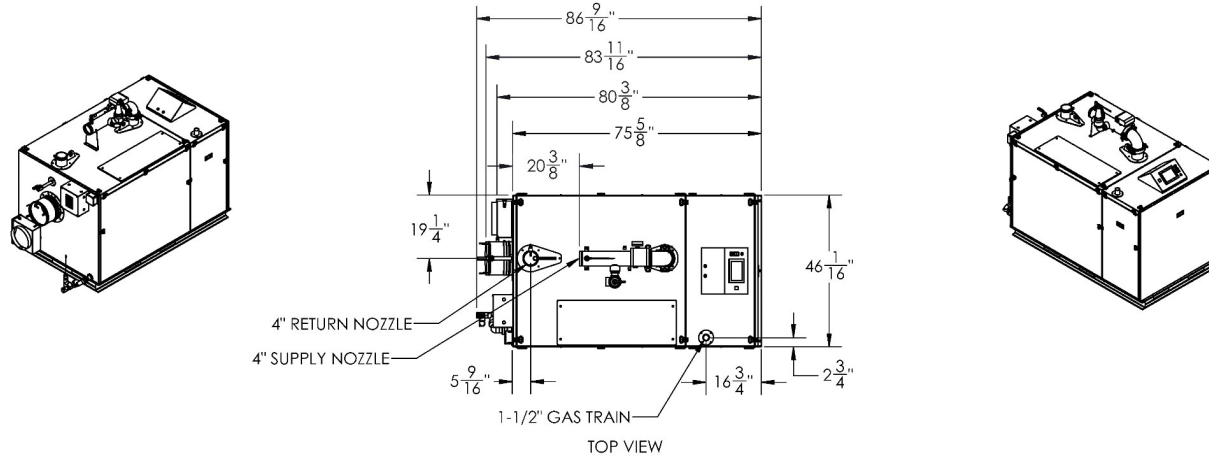

PO BOX 3244 | LANCASTER, PA 17601

## AMPW-2500

INNOVATIVE EQUIPMENT FOR  
HOT WATER SYSTEMS

WWW.THERMALSOLUTIONS.COM

Updated 2/24/26

ABC260201



# Water Heater (DHW) SUBMITTAL DATA SHEET

RATINGS AND CAPACITIES		
Input - Low fire:	<b>500,000</b>	BTU/HR
Input - High Fire:	<b>1,999,000</b>	BTU/HR
Output - High Fire:	<b>2,425,000</b>	BTU/HR
Recovery Rate(per 100°F Temp Rise):	<b>2,970</b>	Gallons Per Hour (GPH)
Thermal Efficiency %:	<b>97</b>	
Heating Surface:	<b>300</b>	Sq.Ft.
Water Vol. (gal)	<b>36</b>	Gallons
Fuel	<b>Natural Gas or LP</b>	
Firing Rate:	<b>Full Modulation</b>	
Burner Turndown:	<b>5:1</b>	
Low NOx Emissions:	<b>&lt;10 ppm</b>	
Inlet Gas Pressure (NG):	<b>4" (Min.) / 14" (Max.)</b>	
Inlet Gas Pressure (LP):	<b>8" (Min.) / 14" (Max.)</b>	
Approx. Shipping Weight (lb)	<b>2,038</b>	lbs
ASME Section IV (Max 160 PSIG / 210°F) Setpoint range is 60-185°F Adjustable, manual reset high limit setting of ≤ 200°F. ASME HLW stamp MAWT is 210°F for the vessel. (For max setpoint, see Setpoint range.) ETL Certified to ANSI Z21.13 / CSA 4.9 ETL Certified to UL 795 / CSA 3.1		



FLOWS AND PRESSURE DROPS			
Delta T	Flow (GPM)	Head Loss (ft)	Water Hardness (GPG)*
25°	<b>245</b>	<b>15.7</b>	<b>12-15</b>
25°	<b>196</b>	<b>11.5</b>	<b>4-12</b>

Electrical Requirements: (Appliance Only)				
Model	Voltage	Phase	Hz	Max. Amp Draw
2000-2500	120	1	60	13.5
	208			8.2
	240			7.7
	208	3	60	11
	240			9.9
	480			6.4
3000	208	1	60	14.1
	240			12.6
	208	3	60	9.9
	480			6.4
3500-4000	208	3	60	11
	240			9.9
	480			6.4

DIMENSIONS / CONNECTIONS		
Height:	<b>55</b>	(Note 1)
Width:	<b>46</b>	(Note 2)
Length:	<b>75-5/8</b>	(Note 3)
Water Outlet Pipe (FNPT):	<b>4</b>	
Water Inlet Pipe (MNPT):	<b>4</b>	
Vent Connection:	<b>10</b>	
Air Intake Connection:	<b>10</b>	
Condensate Drain (PVC):	<b>1</b>	
Drain Line Connection:	<b>3/4</b>	
Gas Inlet Connection (FPT):	<b>2</b>	

NOTES:
1. Height dimension is from floor to top of jacket.
2. Length is from jacket front to jacket rear.
3. Dimensions shown are for reference only
4. Refer to manual for gas supply piping charts



# Water Heater (DHW) SUBMITTAL DATA SHEET

## STANDARD EQUIPMENT

### PRESSURE VESSEL DESIGN

Stainless Steel Heat Exchanger  
 ASME Section IV Certified, "HLW" Stamp  
 MAWP 160 PSIG & Max Temp 210°F  
 Setpoint range is 60-185°F  
 Adjustable, manual reset high limit setting of ≤ 200°F.  
 ASME H stamp MAWT is 210°F for the vessel. (For max setpoint, see Setpoint range.)  
 Ten Year Limited Pressure Vessel Warranty

### COMBUSTION DESIGN

Stainless Steel Pre-Mix Burner	Zero governor gas valve
Low NOx Emissions (< 10 ppm)	Variable Speed Combustion Blower
Full Modulation, 5:1 Turndown	Air Proving Switch
Natural Gas, Propane or Dual Fuel (Gas/Gas)	Blocked Vent Switch
4" wc (8" wc Propane) to 14" wc inlet gas pressure	Manual fuel changeover switch (Dual Fuel Only)
High/Low gas pressure switches, manual reset	Direct Spark Ignition System with UV Scanner

### VENTING

Category II or IV Venting  
 Individual or Common (Engineered) Vent System  
 Vertical or Horizontal  
 CPVC, PP or SS Venting \*Materials Acceptable  
 Combustion Air Intake - Sealed or Room

### APPLIANCE EQUIPMENT

Concert™ Control (24 Vac)	Water Flow Switch
High Limit Temp Control, Manual Reset	Condensate trap
Low water cutoff, manual reset	Blocked Condensate Switch
Supply, Return & DHW Water Temperature Sensors	Pressure & Temperature Gauge
AMSE 150 PSE Relief Valve Standard	Flue Gas Temperature Sensor

### ELECTRICAL DESIGN

#### Models 2000-2500:

- 120-208-230VAC/60HZ/1PH - High Voltage  
 (2000 to 2500 - Optional 208-230-460VAC/60HZ/3PH)

#### Models 3000:

- 208-230-240VAC/60HZ/1PH - High Voltage  
 - 208-230-240-460VAC/60HZ/3PH - High Voltage

#### Models 3500-4000:

- 208-230-240-460VAC/60HZ/3PH - High Voltage  
 - PCB (Printed Circuit Board) Fused Connections  
24VAC/5VDC - Low Voltage PCB

- EMS Communications  
 (Dual RJ45 Jacks for Peer-To-Peer or ModBus)  
 - Boiler Options (Sensors)  
 - Pumps (Boiler, DHW, System) & Auxiliary Devices

\* Flue system material shall be capable of continuous operation at 210°F or higher and shall be certified to UL 1738 – venting system for gas-burning appliances cat II, III and IV.



# Water Heater (DHW) SUBMITTAL DATA SHEET

## OPTIONAL EQUIPMENT

- External High Limit Temperature Control, Manual Reset
- Condensate Neutralizer
- Supply Header Temperature Sensor:  Direct Immersion  Well Immersion (with Well)
- Outdoor Air Temperature Sensor (Wired)
- EMS Signal Converter Kit (Converts Energy or Building Management System 0-10v signal to 4-20mA)
- Motorized Isolation Valves
- Alarm Buzzer with Silencing Switch
- Gas Valve Proving Switch
- Vent Adapter - CPVC
- Universal Communications Gateway (BACnet, Metasys, Modbus or Lonworks)
- Stackable Rack
- Conductor Sequencing Panel

The Conductor manages multiple condensing & non-condensing, small & large heat output, new and/or existing boilers (full modulation or on-off), and steam or hot water applications. It helps improve system efficiency by selecting and modulating the right boiler to match operating conditions. The Conductor offers a single point boiler plant Energy Management System (EMS) interface including Modbus TCP/IP, Modbus RTU RS485, BACnet/IP and BACnet MSTP standard. If Lonworks needed, add for the separate Lonworks gateway.

## EXTENDED WARRANTY

- 3-Year Parts
- 5-Year Parts
- 10-Year Parts
- 5-Year Parts/Labor
- 10-Year Parts/Labor



# Water Heater (DHW) SUBMITTAL DATA SHEET

## CONCERT CONTROL FEATURES

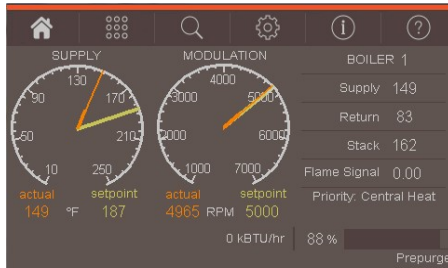

### Dashboard - Color Touchscreen Display, 4"

- Intuitive Icon Navigation
- "Quick" Setup Menus
- \*Real Time BTU/H Display

### Two (2) Temperature Demand Inputs

- Outdoor Air Reset Curve for Each Input
- Time of Day Setback Capability  
(Envirocom Thermostat must be installed)

### Three (3) Pump Control

- Boiler Pump With On/Off or Variable Speed Control
- Domestic Hot Water (DHW) Pump
- System Pump
- Alternative Control to Combustion
  - Air Damper or Standby Loss Damper
- Pump Overrun for Heat Dissipation
- Pump Exercise
- Pump Rotor Seizing Protection

### Peer-to-Peer Boiler Communications

- Multiple Size Boiler Sequencing Up to 8 Units
- \*Two (2) Boiler Start/Stop Trigger
- Lead Boiler Automatic Rotation

### Energy Management System (EMS) Interface

- \*Firing Rate and Water Temperature Based Algorithms for Multiple Boilers; loss of EMS signal defaults to local boiler settings
- 420mAdc Input/Output (010Vdc Optional Converter)
- ModBus Input/Output (BACnet or LonWorks Optional Gateway)
- Simultaneous Interface with Peer-to-Peer

### USB Data Port Transfer

- Upload Settings Between Boilers
- Download Parameters for Troubleshooting
- Import Data into .CRV Formatted Files for Performance Analysis

\* Unique to Concert



### Energy Efficiency Enhancer

- AntiCycling Technology
- Multiplier boiler base load common rate
- Outdoor Air Temperature Reset Curve
- Warm Weather Shutdown
- Boost Temperature & Time
- Ramp Delay
- OverTemperature Safeguarding

### Self-Guiding Diagnostics

- Identifies Fault
- Describes Possible Problems
- Provides Corrective Actions
- Time/Date Stamp on Alarms and Lockouts

### Unmatched Archives

- Historical Trends Collects Up to 4 months Data
- Event History Up to 3000 Alarms, Lockouts and Cycle & Run Times
- Alarm Limit String Faults, Holds, Lockouts and Others
- Cycle & Run Time Boilers & Pumps
- Resettable (Lockouts/Alarms/Cycles & Run Time)

### Domestic Hot Water Priority

- DHW Tank Piped With Priority in the Boiler Loop
- DHW Tank Piped as a Zone in the System With the Pumps Controlled by the Concert Control
- DHW Modulation Limiting
- Status Screens
- Sensor Monitoring and Control

### Other Features

- Factory Default Settings
  - Three Level Password Security
  - Frost Protection
- Contractor Contacts (Up to 3)
- Low Water Flow Safety Control & Indication
- Proportional Integral Derivative (PID) Parameters for Central Heat, DHS, Sequencer and Fan

### Boiler Connect Compatible \*

\* Models 2000-4000 require Service Tool PCB14 Kit (PN#113430-01) and one (1) Boiler Connect Bluetooth Adapter Kit (PN#113329-01) per install or cascade.



# Water Heater (DHW) SUBMITTAL DATA SHEET

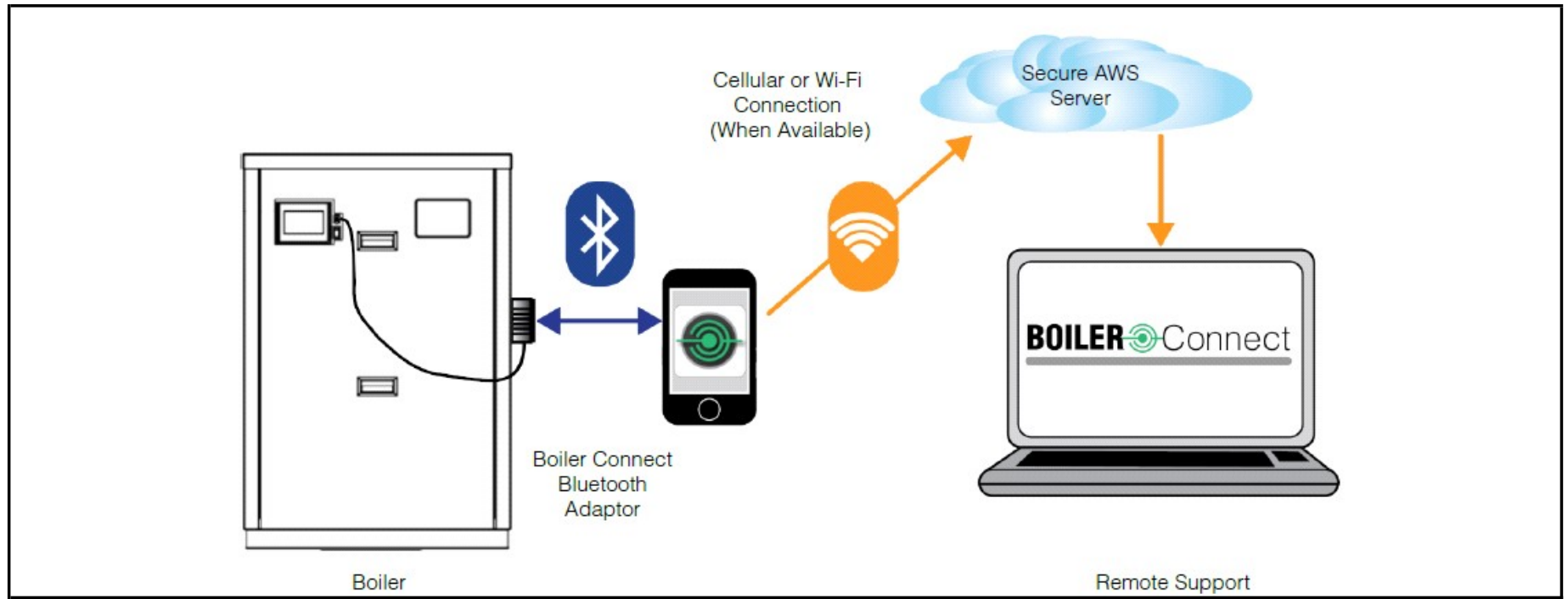

## BOILER Connect

### BOILER CONNECT FEATURES

- Bluetooth adapter connects to the Boiler Connect App
- English or Spanish language
- Start-up, Troubleshooting Tips and Service Wizards
- Data logs, Service and Status Reports sent to the cloud
- Live Data Sharing (Cellular Service Required) with Technical Service Representative