



SPECIFICATION SUBMITTAL

25D K-CP

X - CLOSURE

FIRE-RATED PVC DIRECT WASTE & OVERFLOW KIT

JOB:
CONTRACTOR:
ARCHITECT/ENGINEER:

DATE:
QTY:
PO#:
TAG:

SPECIFICATION

Features a Bell SlideOn™ faceplate, spin-on tie plate, angle adapter, and large strainer. Kit comes with elbow, less 1-1/2" pipe.

CERTIFICATION

 ASME A112.18.2/CSA-B125.2
The "cCSAus" Meets UPC & IPC
Code" mark means the product
conforms to the requirements of
the NPC, UPC, IPC, and IRC.

 CAN/ULC S102.2
Flame Spread Rating 0
Smoke Developed Rating 40

CLOSURES AVAILABLE

Fill X - CLOSURE

CS



PLUG & CHAIN

L

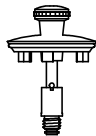

LIFT & TURN
BRASS

LZ

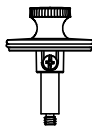

LIFT & TURN
ZINC

Q

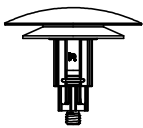

CLICKER®

TIP

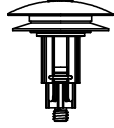

TIP-TOE

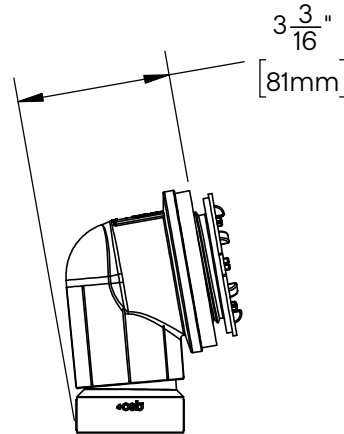

25DQK-CP
SHOWN

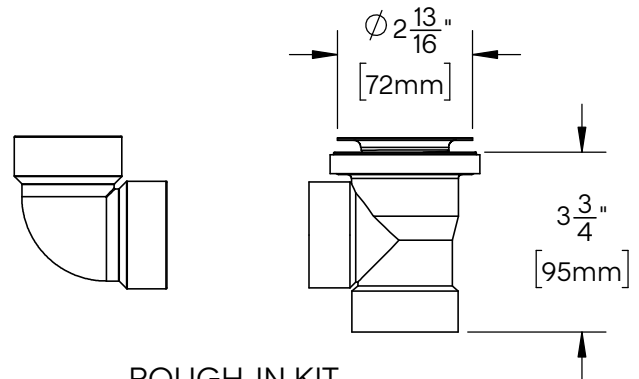

ROUGH-IN KIT
SHOWN

Oakville Stamping and Bending Ltd.

T. 905.827.0320 or toll free 1.877.314.6040 F. 905.827.6375 or toll free 1.877.827.6040

All rights reserved. +osb™ reserves the right to change product specifications and material or discontinue models without notice.

www.osb.ca (Canada) www.osbplumbing.com (USA)

06/26/26

