

LED Flush Mount

FM0723316

INSTALLATION SHEET

START FROM HERE

- Make sure **POWER** is **COMPLETELY OFF** at the fuse box
- Have your fixture installed by a qualified licensed electrician
- Prepare everything in a clear area
- Wear gloves at all time during this installation
- Read instructions carefully before you start assembly
- Keep this installation sheet for future reference

Please Note:

- This LED fixture comes with pre-wired LED module(s)
- Unless instructed, Do Not touch any part of the LED module(s) as any unnecessary contact with the module could cause permanent damage
- For dimming, an ELV (Electronic Low Voltage) type of dimmer is required
- 120V input

- 1.** Remove fixture from its original package
- 2.** Separate mounting plate (**1c**) from fixture (**2a**) by removing decorative nuts (**2c**)
- 3.** Align mounting plate screws (**1d**) to desired orientation, and then attach mounting plate (**1c**) to electrical junction box (**1a**) using junction box screws provided (**1e**) in hardware package
- 4.** Make proper electrical connections (**black** to **hot "L"**, **white** to **neutral "N"**, **ground** to **"GND"**) with wire nuts (**1b**) provided in hardware package
- 5.** Align and insert mounting plate screws (**1d**) through holes on fixture (**2a**), secure with decorative nuts (**2c**)
- 6.** Secure diffuser (**2b**) to fixture (**2a**) by threading clockwise

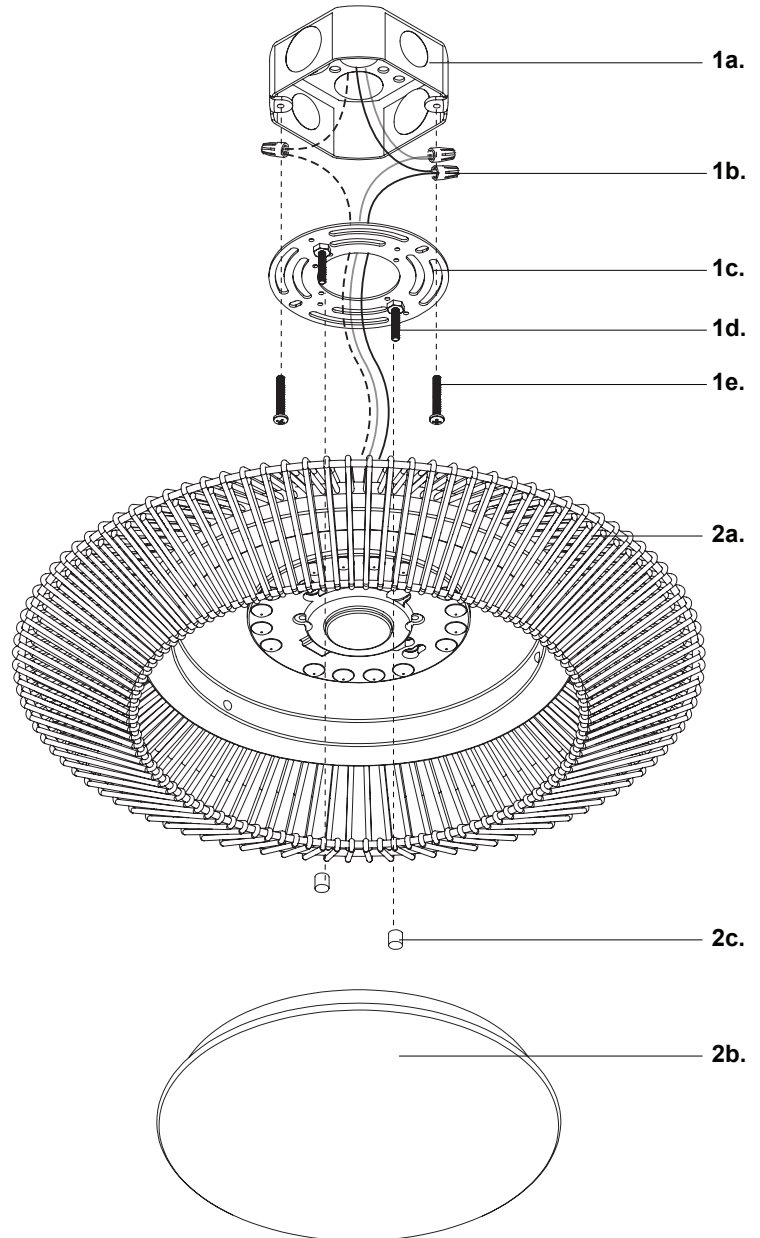

SoModern

T: 1.833.8SO.MDRN (76.6376)

W: www.somodernlighting.com

E: info@somodernlighting.com