

MP316406-UNV

Multi Pendant

TECHNICAL SUPPORT

1.855.855.8926

technicalsupport@aloralighting.com

⚠ WARNINGS AND CAUTIONS

- Make sure **POWER** is **COMPLETELY OFF** at the fuse box
- Have your fixture installed by a qualified licensed electrician
- Prepare everything in a clear area
- Wear gloves at all times during this installation
- Read instructions carefully before you start assembly
- Keep this installation sheet for future reference

Please Note:

- This Alora LED fixture comes with pre-wired LED module(s)
- Unless instructed, Do Not touch any part of the LED module(s) as any unnecessary contact with the module could cause permanent damage
- For dimming, an ELV (Electronic Low Voltage) or TRIAC type of dimmer is required
- 120-277V input

NOTICE

- The important safeguards and instructions outlined in this sheet cannot cover all possible conditions and situations that may occur. It must be understood that caution and certain care factors must be followed. These instructions are provided for your safety and we highly recommend that a licensed, trained electrician install this unit.
- This fixture is designed to be mounted on a correctly installed standard round or octagon box OR through a wiring box with a plaster frame. The box must be securely mounted to the structure of the building. The crossbar and hardware supplied should be used, directly mounting the fixture to the outlet box may make it impossible to correctly align the fixture.

ASSEMBLY INSTRUCTIONS

Step 1

Remove fixture from its original package.

Step 2

Separate mounting plate (1c) from canopy (2a) by removing canopy screws (2b).

Step 3

Attach mounting plate (1c) to electrical junction box (1a) using screws provided (1e) in hardware package.

Step 4

Determine hanging height of fixture by securing rods (2d) to canopy pivot (2e) and pendant body (5a) after feeding fixture wires (LED+ and LED-) through rods.

Step 5

Make proper electrical connections between LED and DC driver, LED- Negative, LED+ Positive using quick connector provided (See Illustration 1 and refer to diagram on driver).

Step 6

Make proper electrical connections (**black to hot "L", white to neutral "N", ground to "GND"**) with wire nuts (1b) provided in hardware package and place driver (4a) inside canopy (2a).

Step 7

Attach shade (3c) to fixture arm (3a) and secure with filament (3b), followed by nut (3d) by threading clockwise.

Step 8

Attach canopy (2a) to mounting plate (1c) with canopy screws (2b).

You are now ready to enjoy your fixture.

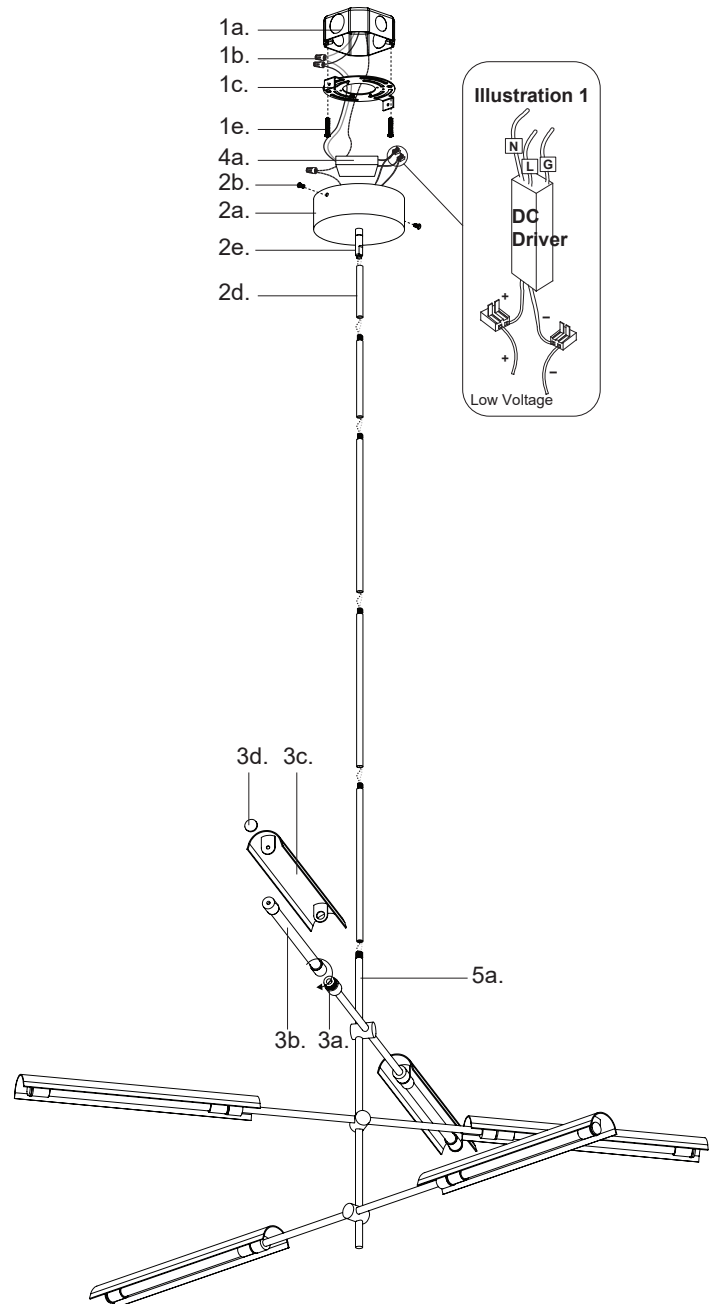

alora

P: 1.855.855.8926

CANADA: 19054 28th Avenue Surrey - BC V3Z 6M3

USA: 3035 E. Lone Mountain Rd - Las Vegas, NV, 89081

www.aloralighting.com

20240820