

# Ceiling LED Pendant

# PD0737705

INSTALLATION SHEET

## START FROM HERE

- Make sure **POWER** is **COMPLETELY OFF** at the fuse box
- Have your fixture installed by a qualified licensed electrician
- Prepare everything in a clear area
- Wear gloves at all time during this installation
- Read instructions carefully before you start assembly
- Keep this installation sheet for future reference

## Please Note:

- This LED fixture comes with pre-wired LED module(s)
- Unless instructed, Do Not touch any part of the LED module(s) as any unnecessary contact with the module could cause permanent damage
- Use ELV (Electronic Low Voltage) or TRIAC type of dimmer for dimming application
- 120-277V input

- 1.** Remove fixture from its original package
- 2.** Separate mounting plate (**1c**) from canopy (**2a**) by removing canopy screws (**2b**)
- 3.** Attach mounting plate (**1c**) to electrical junction box (**1a**) using junction box screws provided (**1e**) in hardware package
- 4.** To change fixture height, push and hold wire gripper (**2g**), slide wire to desired length and then release wire gripper (**2g**) to secure
- 5.** Make proper electrical connections (**black** to **hot "L"**, **white** to **neutral "N"**, **ground** to **"GND"**) with wire nuts (**1b**) provided in hardware package
- 6.** Attach canopy (**2a**) to mounting plate (**1c**) with canopy screws (**2b**)

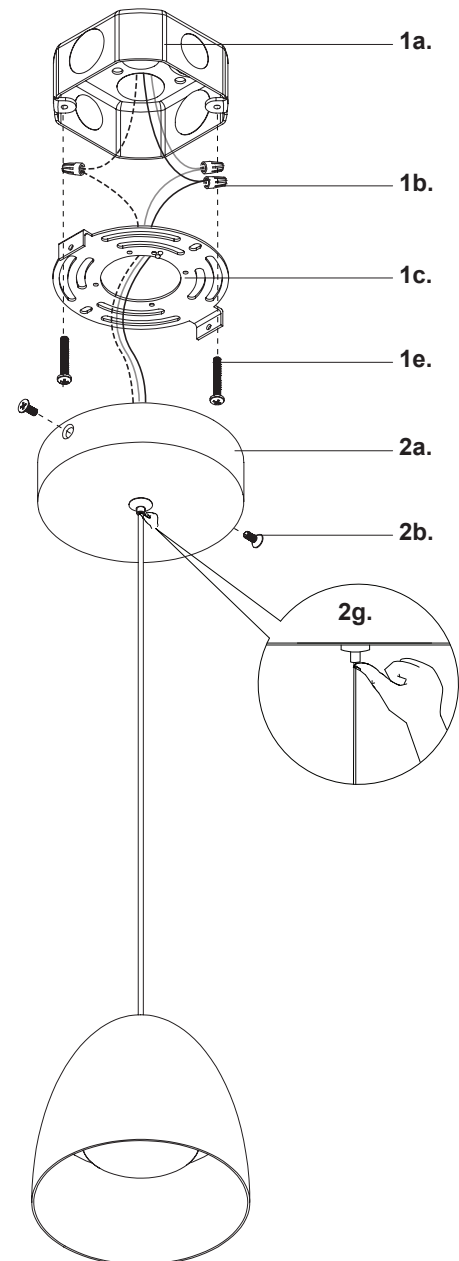

## SoModern

T: 1.833.8SO.MDRN (76.6376)

W: [www.somodernlighting.com](http://www.somodernlighting.com)

E: [info@somodernlighting.com](mailto:info@somodernlighting.com)