

NOTE:

- 1) MATERIAL : NYLON66, UL94-V0, GLOW WIRE COMPATIBLE.
- 2) FOR USE WITH AFCI RECEPTACLE HOUSING 10153466 & 10153467.
- 3) FOR USE WITH AFCI PLUG HOUSING 10153592
- 4) USE TWO TPA ALIGNERS FOR DUAL ROW HOUSING AND ONE TPA ALIGNER FOR SINGLE ROW HOUSING

PART NUMBER SCHEME:

10153465-XX X LE

POSITION CODE      COLOUR:

02 → 2 POSITION      B → Black

03 → 3 POSITION

04 → 4 POSITION

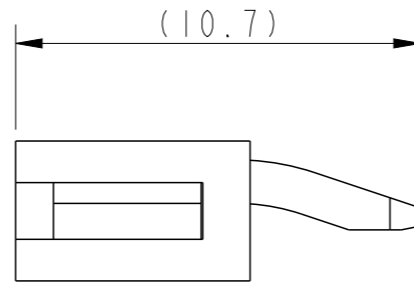
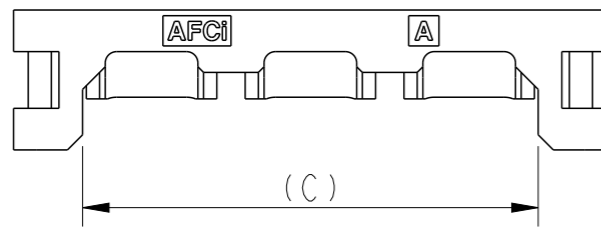

PART NO.	A	B	C
10153465-02XLF	9.5	4.2	7.85
10153465-03XLF	13.7	8.4	12.05
10153465-04XLF	17.9	12.6	16.25

spec ref	dr	Akhil Rajan	2020/06/29	projection	MM	size	A3	scale	5:1
tolerance std	eng	Paul Mithun	2020/06/29			ecn no	-	rel level	Released
ISO 406 ISO 1101	chr	-	-						
surface	linear	0.X	±0.30	<b>Amphenol FCI</b>	TPA ALIGNER Minitek Power 4.2	dwg no	10153465	rev	A
		0.XX	±0.25						
		0.XXX	±						
ISO 1302	angular	0°	±2°	cat. no.	Product - Customer Drw	sheet 1 of 2			

1

2

3

4

A

B

C

D

A

B

C

D

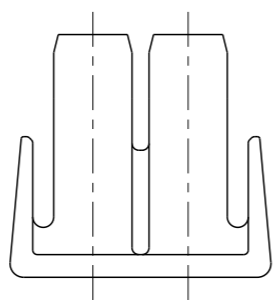

02 Pos.

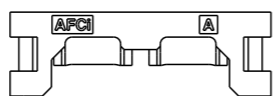
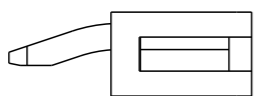

03 Pos.

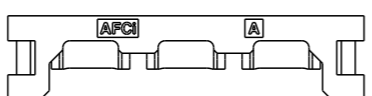

04 Pos.

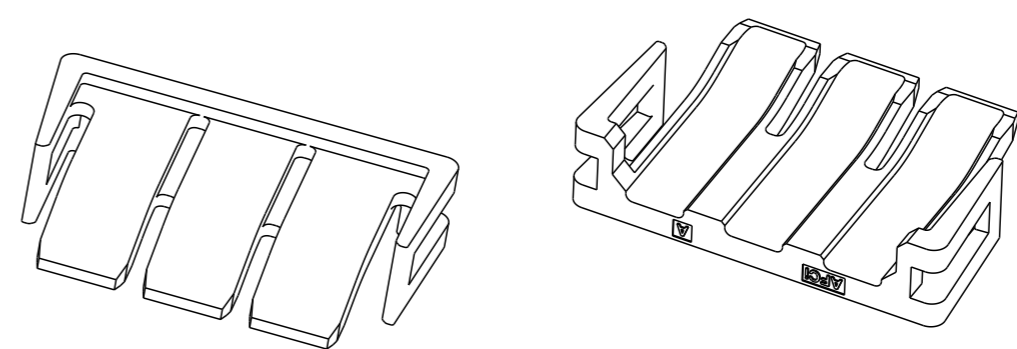
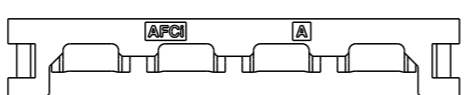
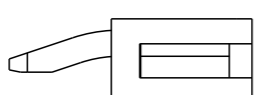

10153465-03XLF

Amphenol  
FCi

© 2016 APCI

spec ref		dr	Akhil Rajan	2020/06/29	projection	MM	size	A3	scale	5:1	
tolerance std		eng	Paul Mithun	2020/06/29			ecn no		-		
ISO 406 ISO 1101		chr	-	-			rel level		Released		
surface		appr	Kuriakose, San	2020/06/29	product family			rel level		Released	
ISO 1302		linear		0.X	±0.30			TPA ALIGNER Minitek Power 4.2		dwg no 10153465	rev A
		linear		0.XX	±0.25	cat. no.		Product - Customer Drw		sheet 2 of 2	
		angular		0°	±2°	PDS: Rev :A		STATUS:Released		Printed: Jun 29, 2020	

2

3

4