

## QDD-400GB-FR4-10-C-C

Cisco® Compatible TAA 400GBase-FR4 QSFP-DD Transceiver (SMF, 1310nm, 10km, LC, DOM, 0 to 70C)

### Features:

- INF-8628 Compliance
- Duplex LC Connector
- Single-mode Fiber
- Commercial Temperature 0 to 70 Celsius
- Hot Pluggable
- Metal with Lower EMI
- Excellent ESD Protection
- RoHS Compliant and Lead Free

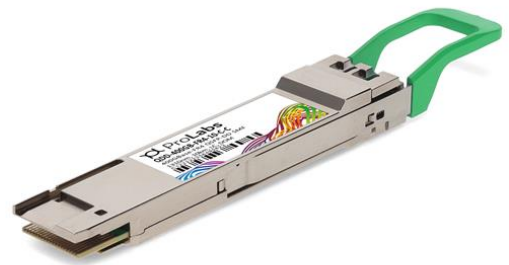

### Applications:

- 400GBase Ethernet
- Access and Enterprise

### Product Description

This Cisco® compatible QSFP-DD transceiver provides 400GBase-FR4 throughput up to 10km over single-mode fiber (SMF) using a wavelength of 1310nm via an LC connector. It can operate at temperatures between 0 and 70C. Our transceiver is built to meet or exceed OEM specifications and is guaranteed to be 100% compatible with Cisco®. It has been programmed, uniquely serialized, and tested for data-traffic and application to ensure that it will initialize and perform identically. All of our transceivers comply with Multi-Source Agreement (MSA) standards to provide seamless network integration. Additional product features include Digital Optical Monitoring (DOM) support which allows access to real-time operating parameters. This transceiver is Trade Agreements Act (TAA) compliant. We stand behind the quality of our products and proudly offer a limited lifetime warranty.

ProLabs' transceivers are RoHS compliant and lead-free.

TAA refers to the Trade Agreements Act (19 U.S.C. & 2501-2581), which is intended to foster fair and open international trade. TAA requires that the U.S. Government may acquire only "U.S.-made or designated country end products."



### Absolute Maximum Ratings

Parameter	Symbol	Min.	Max.	Unit
Power Supply Voltage	Vcc	-0.5	3.6	V
Storage Temperature	Tstg	-40	85	°C
Operating Case Temperature	Tc	0	70	°C
Relative Humidity (Non-Condensing)	RH	0	85	%

### Recommended Operating Conditions

Parameter	Symbol	Min.	Typ.	Max.	Unit	Notes
Operating Case Temperature	Tc	0		70	°C	
Power Supply Voltage	Vcc	3.135	3.3	3.465	V	
Data Rate Per Lane			26.5625		GBd	PAM4
Data Rate Accuracy		-100		100	ppm	
Pre-FEC Bit Error Ratio				$2.4 \times 10^{-4}$		
Post-FEC Bit Error Ratio				$1 \times 10^{-12}$		1
Link Distance	D	0.5		10	km	2

#### Notes:

1. FEC provided by host system.
2. FEC required on host system to support maximum distance.

## Electrical Characteristics

Parameter	Symbol	Min.	Typ.	Max.	Unit	Notes
Power Consumption				12	W	
Supply Current	I <sub>cc</sub>			3.64	A	
<b>Transmitter (Per Lane)</b>						
Signaling Rate Per Lane	TP1	26.5625 ± 100 ppm			GBd	
Differential pk-pk Input Voltage Tolerance	TP1a	900			mVp-p	1
Differential Termination Mismatch	TP1			10	%	
Differential Input Return Loss	TP1	IEEE 802.3-2015 Equation (83E-5)			dB	
Differential to Common-Mode Input Return Loss	TP1	IEEE 802.3-2015 Equation (83E-6)			dB	
Module Stressed Input Test	TP1a	See IEEE 802.3bs 120E.3.4.1				2
Single-Ended Voltage Tolerance Range (Minimum)	TP1a	-0.4 to 3.3			V	
DC Common-Mode Input Voltage	TP1	-350		2850	mV	3
<b>Receiver (each lane)</b>						
Signaling Rate Per Lane	TP4	26.5625 ± 100 ppm			GBd	
Differential pk-pk Output Voltage	TP4			900	mVp-p	
AC Common-Mode Output Voltage, RMS	TP4			17.5	mV	
Differential Termination Mismatch	TP4			10	%	
Differential Output Return Loss	TP4	IEEE 802.3-2015 Equation (83E-2)				
Common to Differential-Mode Conversion Return Loss	TP4	IEEE 802.3-2015 Equation (83E-3)				
Transition Time (20% to 80%)	TP4	9.5			ps	
Near-end Eye Symmetry Mask Width (ESMW)	TP4		0.265		UI	
Near-End Eye Height (Differential)	TP4	70			mV	
Far-End Eye Symmetry Mask Width (ESMW)	TP4		0.2		UI	
Far-End Eye Height (Differential)	TP4	30			mV	
Far-End Precursor ISI Ratio	TP4	-4.5		2.5	%	
Common-Mode Output Voltage (V <sub>cm</sub> )	TP4	-350		2850	mV	3

### Notes:

1. With the exception to IEEE 802.3bs 120E.3.1.2 that the pattern is PRBS31Q or scrambled idle.
2. Meets BER specified in IEEE 802.3bs 120E.1.1.
3. DC common-mode voltage generated by the host. Specification includes the effects of ground offset voltage.

## Optical Characteristics

Parameter	Symbol	Min.	Typ.	Max.	Unit	Notes
Lane Wavelength	L0	1264.5	1271	1277.5	nm	
	L1	1284.5	1291	1297.5		
	L2	1304.5	1311	1317.5		
	L3	1324.5	1331	1337.5		
<b>Transmitter</b>						
Data Rate Per Lane		53.125 ± 100 ppm			GBd	
Modulation Format		PAM4				
Side-Mode Suppression Ratio	SMSR	30			dB	Modulated
Total Average Launch Power	PT			10	dBm	
Average Launch Power Per Lane	PAVG	-1.4		4.5	dBm	1
Outer Optical Modulation Amplitude (OMA <sub>outer</sub> ) Per Lane	POMA	0.7		4.7	dBm	2
Launch Power in OMA <sub>outer</sub> Minus TDECQ, Per Lane		-0.7			dB	For ER ≥4.5dB
Launch Power in OMA <sub>outer</sub> Minus TDECQ, Per Lane		-0.6			dB	For ER <4.5dB
Transmitter and Dispersion Eye Closer for PAM4 Per Lane	TDECQ			3.4	dB	
Extinction Ratio	ER	3.5			dB	
Difference in Launch Power Between Any Two Lanes (OMA <sub>outer</sub> )				4	dB	
RIN <sub>15,6OMA</sub>	RIN			-136	dB/Hz	
Optical Return Loss Tolerance	TOL			15.6	dB	
Transmitter Reflectance	TR			-26	dB	
Average Launch Power of OFF Transmitter Per Lane	P <sub>off</sub>			-20	dBm	
<b>Receiver</b>						
Data Rate Per Lane		53.125 ± 100 ppm			GBd	
Modulation Format		PAM4				
Damage Threshold Per Lane	THd	5.5			dBm	3
Average Receive Power Per Lane		-7.7		4.5	dBm	4
Receive Power (OMA <sub>outer</sub> ) Per Lane				4.7	dBm	
Difference in Receiver Power Between Any Two Lanes (OMA <sub>outer</sub> )				4.1	dB	
Receiver Sensitivity (OMA <sub>outer</sub> ) Per Lane	SEN			-6.6	dBm	For BER of 2.4E-4
Stressed Receiver Sensitivity (OMA <sub>outer</sub> ) Per Lane	SRS	See Figure Below			dBm	5
Receiver Reflectance				-26	dB	
LOS Assert	LOSA	-30			dBm	
LOS De-Assert	LOSD			-12	dBm	
LOS Hysteresis	LOSH	0.5			dB	

Stressed Conditions for Stress Receiver Sensitivity (Note 6)						
Stressed Eye Closure for PAM4 (SECQ) Per Lane Under Test		0.9		3.4	dB	
OMA <sub>outer</sub> of Each Aggressor Lane			1.5		dBm	

**Notes:**

1. Average launch power, each lane (minimum), is informative and not the principal indicator of signal strength. A transmitter with launch power below this value cannot be compliant; however, a value above this does not ensure compliance.
2. Even if the TDECQ<1.4 dB for an extinction ratio of ≥4.5 dB or TDECQ<1.3 dB for an extinction ratio of <4.5 dB, the OMA<sub>outer</sub> (minimum) must exceed the minimum value specified here.
3. The receiver shall be able to tolerate, without damage, continuous exposure to an optical input signal having this average power level.
4. Average receive power, each lane (minimum), is informative and not the principal indicator of signal strength. A received power below this value cannot be compliant; however, a value above this does not ensure compliance.
5. Measured with conformance test signal for BER=2.4x10<sup>-4</sup>. A compliant receiver shall have stressed receiver sensitivity (OMA<sub>outer</sub>), each lane values below the mask of the figure below, for SECQ values between 0.9 and 3.4 dB.
6. These test conditions are for measuring stressed receiver sensitivity. They are not characteristics of the receiver.

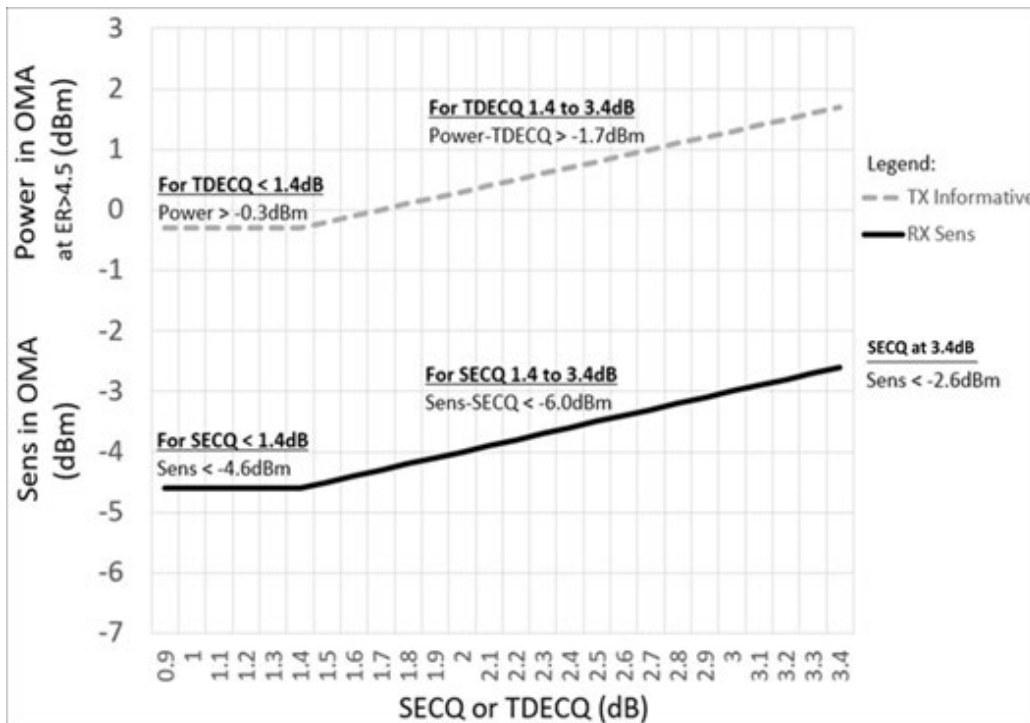

## Pin Descriptions

Pin	Logic	Symbol	Name/Descriptions	Plug Sequence
1		GND	Module Ground.	1B
2	CML-I	Tx2-	Transmitter Inverted Data Input.	3B
3	CML-I	Tx2+	Transmitter Non-Inverted Data Input.	3B
4		GND	Module Ground.	1B
5	CML-I	Tx4-	Transmitter Inverted Data Input.	3B
6	CML-I	Tx4+	Transmitter Non-Inverted Data Input.	3B
7		GND	Module Ground.	1B
8	LVTTTL-I	ModSelL	Module Select.	3B
9	LVTTTL-I	ResetL	Module Reset.	3B
10		VccRx	+3.3V Power Supply Receiver.	2B
11	LVCNOS-I/O	SCL	2-Wire serial Interface Clock.	3B
12	LVCNOS-I/O	SDA	2-wire serial Interface Data.	3B
13		GND	Module Ground.	1B
14	CML-O	Rx3+	Receiver Non-Inverted Data Output.	3B
15	CML-O	Rx3-	Receiver Inverted Data Output.	3B
16	GND	Ground	Module Ground.	
17	CML-O	Rx1+	Receiver Non-Inverted Data Output.	3B
18	CML-O	Rx1-	Receiver Inverted Data Output.	3B
19		GND	Module Ground.	1B
20		GND	Module Ground.	1B
21	CML-O	Rx2-	Receiver Inverted Data Output.	3B
22	CML-O	Rx2+	Receiver Non-Inverted Data Output.	3B
23		GND	Module Ground.	1B
24	CML-O	Rx4-	Receiver Inverted Data Output.	3B
25	CML-O	Rx4+	Receiver Non-Inverted Data Output.	3B
26		GND	Module Ground.	1B
27	LVTTTL-O	ModPrsL	Module Present.	3B
28	LVTTTL-O	IntL	Interrupt.	3B
29		VccTx	+3.3V Power Supply Transmitter.	2B
30		Vcc1	+3.3V Power Supply.	2B
31	LVTTTL-I	InitMode	Initialization Mode. In legacy QSFP applications, the "InitMode" pad is called LPMODE.	3B
32		GND	Module Ground.	1B
33	CML-I	Tx3+	Transmitter Non-Inverted Data Input.	3B
34	CML-I	Tx3-	Transmitter Inverted Data Input.	3B
35		GND	Module Ground.	1B
36	CML-I	Tx1+	Transmitter Non-Inverted Data Input.	3B
37	CML-I	Tx1-	Transmitter Inverted Data Input.	3B
38		GND	Module Ground.	1B
39		GND	Module Ground.	1A
40	CML-I	Tx6-	Transmitter Inverted Data Input.	3A

41	CML-I	Tx6+	Transmitter Non-Inverted Data Input.	3A
42		GND	Module Ground.	1A
43	CML-I	Tx8-	Transmitter Inverted Data Input.	3A
44	CML-I	Tx8+	Transmitter Non-Inverted Data Input.	3A
45		GND	Module Ground.	1A
46		Reserved	For Future Use.	3A
47		VS1	Module Vendor-Specific 1.	3A
48		VccRx1	+3.3V Power Supply.	2A
49		VS2	Module Vendor-Specific 2.	3A
50		VS3	Module Vendor-Specific 3.	3A
51		GND	Module Ground.	1A
52	CML-O	Rx7+	Receiver Non-Inverted Data Output.	3A
53	CML-O	Rx7-	Receiver Inverted Data Output.	3A
54		GND	Module Ground.	1A
55	CML-O	Rx5+	Receiver Non-Inverted Data Output.	3A
56	CML-O	Rx5-	Receiver Inverted Data Output.	3A
57		GND	Module Ground.	1A
58		GND	Module Ground.	1A
59	CML-O	Rx6-	Receiver Inverted Data Output.	3A
60	CML-O	Rx6+	Receiver Non-Inverted Data Output.	3A
61		GND	Module Ground.	1A
62	CML-O	Rx8-	Receiver Inverted Data Output.	3A
63	CML-O	Rx8+	Receiver Non-Inverted Data Output.	3A
64		GND	Module Ground.	1A
65		NC	No Connected.	3A
66		Reserved	For Future Use.	3A
67		VccTx1	+3.3V Power Supply Transmitter.	2A
68		Vcc2	+3.3V Power Supply.	2A
69		Reserved	For Future Use.	3A
70		GND	Module Ground.	1A
71	CML-I	Tx7+	Transmitter Non-Inverted Data Input.	3A
72	CML-I	Tx7-	Transmitter Inverted Data Input.	3A
73		GND	Module Ground.	1A
74	CML-I	Tx5+	Transmitter Non-Inverted Data Input.	3A
75	CML-I	Tx5-	Transmitter Inverted Data Input.	3A
76		GND	Module Ground.	1A

# MSA Compliant Connector

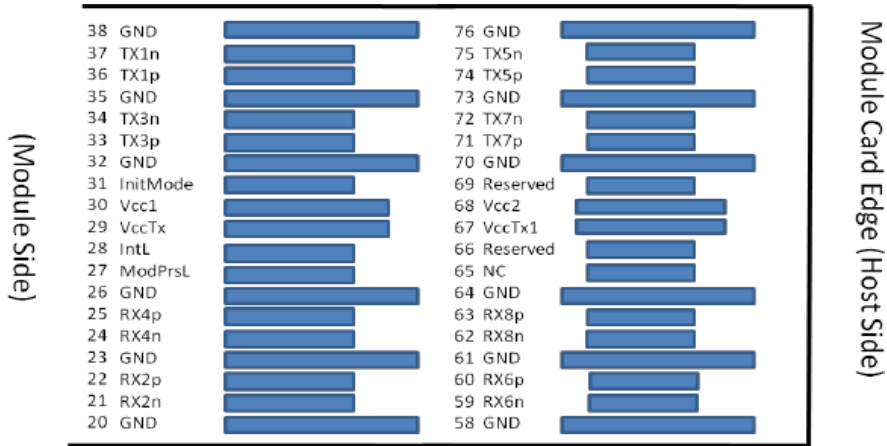

Top side viewed from top

Legacy QSFP28 Pads      Additional QSFP-DD Pads

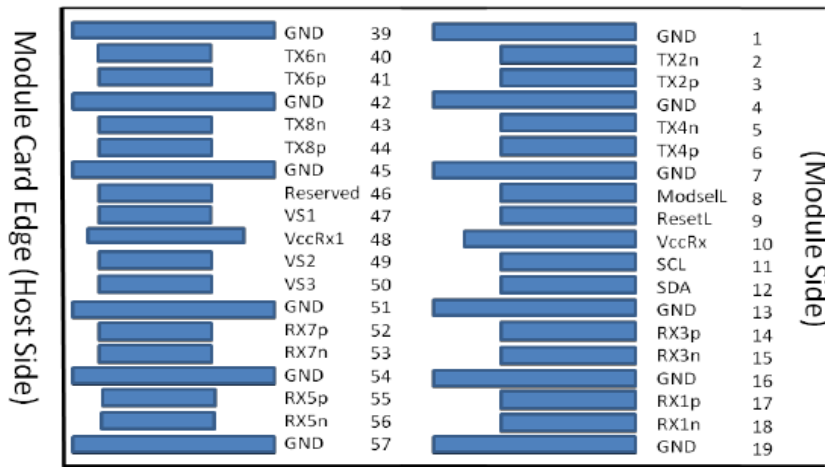

Bottom side viewed from bottom

Additional QSFP-DD Pads      Legacy QSFP28 Pads

## Recommended Power Supply Filter

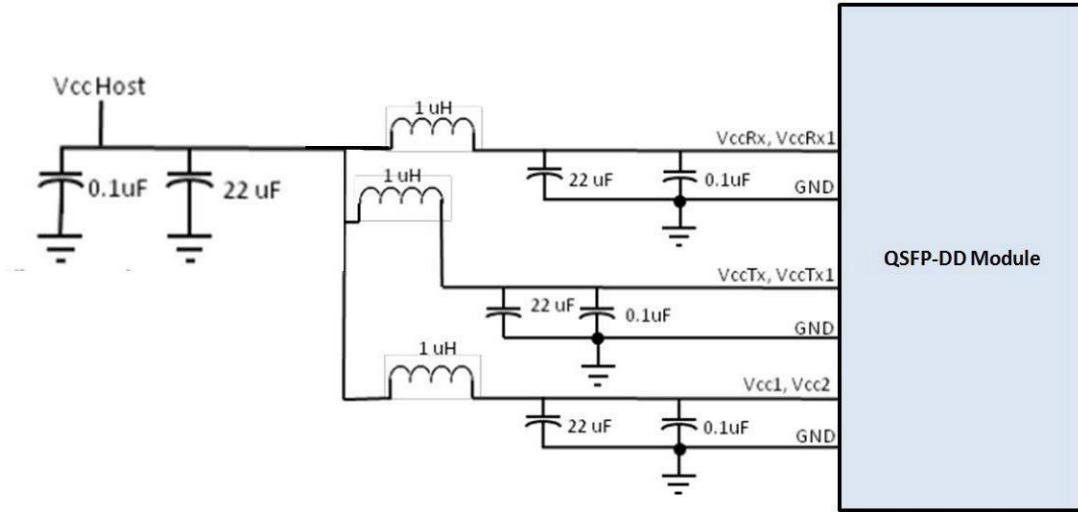

## Digital Diagnostic Functions

The following digital diagnostic characteristics are defined over the normal operating conditions unless otherwise specified.

Parameter	Symbol	Min	Max	Units	Notes
Temperature Monitor Absolute Error	DMI_Temp	-3	3	degC	Over Operating Temperature Range
Supply Voltage Monitor Absolute Error	DMI_Vcc	-0.1	0.1	V	Over Full Operating Range
Channel Rx Power Monitor Absolute Error	DMI_RX_Ch	-2	2	dB	1
Channel Bias Current Monitor	DMI_Ibias_Ch	-10%	10%	mA	
Channel TX power Monitor Absolute Error	DMI_TX_Ch	-2	2	dB	1

### Notes:

1. Due to measurement accuracy of different single-mode fibers, there could be an additional +/-1 dB fluctuation, or a +/- 3 dB total accuracy.

**Mechanical Specifications**

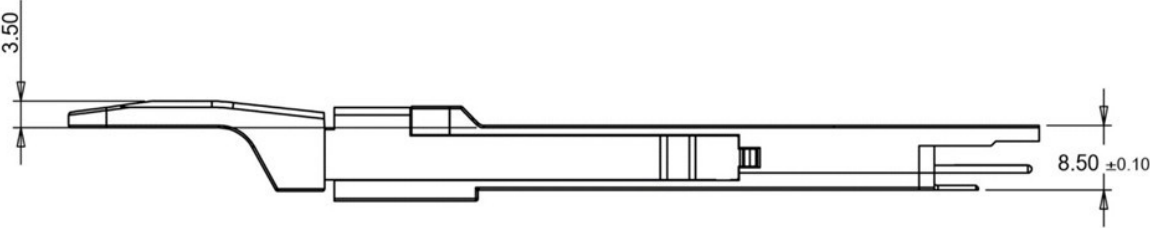
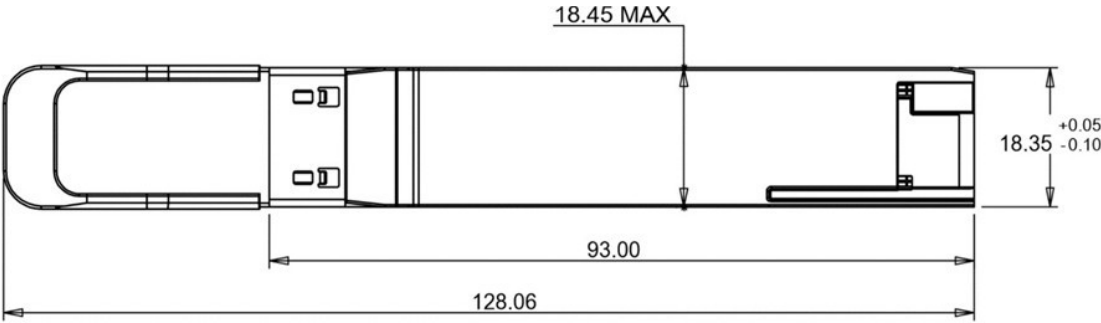

## About ProLabs

Our extensive experience comes as standard. For over 20 years ProLabs has delivered optical connectivity solutions that give our customers freedom and choice through our ability to provide seamless interoperability. At the heart of our company is the ability to provide state-of-the-art optical transport and connectivity solutions that are compatible with more than 100 optical switching and transport platforms.

## A Complete Portfolio of Network Solutions

ProLabs is focused on innovations in optical transport and connectivity. The combination of our knowledge of optics and networking equipment enables ProLabs to be your single source for optical transport and connectivity solutions from 100Mb to 1.6T while providing innovative solutions that increase network efficiency. We provide the optical connectivity expertise that is compatible with and enhances your switching and transport equipment.

## The Trusted Partner

Customer service is our number one value. ProLabs has invested in people, labs and manufacturing capacity to ensure compatible products, and immediate answers to your questions. With Engineering and Manufacturing offices in the U.K. and U.S. augmented by field offices throughout the U.S., U.K. and Asia, ProLabs is able to be our customers best advocate 24 hours a day.



## Contact Information

ProLabs US

Email: [sales@prolabs.com](mailto:sales@prolabs.com)

Telephone: 952-852-0252

ProLabs UK

Email: [salessupport@prolabs.com](mailto:salessupport@prolabs.com)

Telephone: +44 1285 719 600