

QSFPDD4-400GB-AOC6MLP-C-C

Cisco® Compatible TAA 400GBase-AOC QSFP-DD to QSFP-DD Low Power Active Optical Cable (850nm, MMF, 6m)

Features:

- QSFP-DD MSA HW Rev. 5.0 compliant
- CMIS 4.0 compliant
- 8x26.56GBaud optical links with integrated CDR
- OM3 multi-mode fiber
- CML compatible electrical I/O
- PAM4 & NRZ compatible
- OFNP jacket
- Operating Temperature 0 to 70 Celsius
- Hot pluggable
- RoHS compliant and lead-free



Applications:

- 400GBase Ethernet

Product Description

This is a Cisco® compatible 400GBase-AOC QSFP28 to QSFP28 active optical cable that operates over active fiber with a maximum reach of 6.0m (19.7ft). At a wavelength of 850nm, it has been programmed, uniquely serialized, and data-traffic and application tested to ensure it is 100% compliant and functional. This active optical cable is TAA (Trade Agreements Act) compliant, and is built to comply with MSA (Multi-Source Agreement) standards. We stand behind the quality of our products and proudly offer a limited lifetime warranty.

ProLabs' transceivers are RoHS compliant and lead-free.

TAA refers to the Trade Agreements Act (19 U.S.C. & 2501-2581), which is intended to foster fair and open international trade. TAA requires that the U.S. Government may acquire only "U.S.-made or designated country end products.")



Absolute Maximum Ratings

Parameter	Symbol	Min.	Typ.	Max.	Unit	Notes
Storage Ambient Temperature	Tstg	-40		85	°C	
Operating Case Temperature	Tc	0	25	70	°C	1
Module Supply Voltage	Vcc	3.14	3.3	3.46	V	
Power Consumption	Pd		7	7.27	W	
Single Module Supply Current	I _{IN}		2100		mA	
Relative Humidity – Storage	RH _{stg}	0		95	%	2
Relative Humidity – Operating	RH _{op}	0		85	%	2
Signaling Speed Per Channel	S		26.56		GBaud	

Notes:

1. Commercial temperature range.
2. RH is a non-condensing condition.
3. Exceeding the Absolute Maximum Ratings may cause irreversible damage to the device. The device is not intended to be operated under the conditions of simultaneous Absolute Maximum Ratings, a condition which may cause irreversible damage to the device.

Cable Specifications

Parameter	Value	Unit
Cable Diameter	3.0 ± 0.15	mm
Minimum Bend Radius	30	mm

Electrical Characteristics

Parameter	Symbol	Min.	Typ.	Max.	Unit	Notes
Power Supply Voltage	Vcc	3.14	3.3	3.46	V	
Transmitter						
Tx_Data Differential Input Voltage	V _{IN}	400		900	mV	
Tx_Data Differential Input Impedance	Z _{IN}		100		Ω	
Receiver						
Rx_Data Differential Output Voltage	V _{OUT}			900	mV	
Rx_Data Differential Output Impedance	Z _{OUT}	90	100	110	Ω	
Link BER	BER			2.4E ⁻⁴		1

Notes:

1. Better than 2.4E⁻⁴ @26.56GBaud PRBS31.

Pin Descriptions

Pin	Symbol	Name/Description	Notes
1	GND	Module Ground.	
2	Tx2-	Transmitter Inverted Data Input.	
3	Tx2+	Transmitter Non-Inverted Data Input.	
4	GND	Module Ground.	
5	Tx4-	Transmitter Inverted Data Input.	
6	Tx4+	Transmitter Non-Inverted Data Input.	
7	GND	Module Ground.	
8	ModSelL	Module Select.	
9	ResetL	Module Reset.	
10	VccRx	+3.3V Receiver DC Power Supply.	
11	SCL	I ² C Serial Clock.	
12	SDA	I ² C Serial Data.	
13	GND	Module Ground.	
14	Rx3+	Receiver Non-Inverted Differential Output.	
15	Rx3-	Receiver Inverted Differential Output.	
16	GND	Module Ground.	
17	Rx1+	Receiver Non-Inverted Differential Output.	
18	Rx1-	Receiver Inverted Differential Output.	
19	GND	Module Ground.	
20	GND	Module Ground.	
21	Rx2-	Receiver Inverted Differential Output.	
22	Rx2+	Receiver Non-Inverted Differential Output.	
23	GND	Module Ground.	
24	Rx4-	Receiver Inverted Differential Output.	
25	Rx4+	Receiver Non-Inverted Differential Output.	
26	GND	Module Ground.	
27	ModPrsL	Module Present.	
28	IntL	Interrupt.	
29	VccTx	+3.3V Transmitter DC Power Supply.	
30	Vcc1	+3.3V DC Power Supply.	
31	Init Mode	Initialization Mode.	
32	GND	Module Ground.	
33	Tx3+	Transmitter Non-Inverted Data Input.	
34	Tx3-	Transmitter Inverted Data Input.	
35	GND	Module Ground.	

36	Tx1+	Transmitter Non-Inverted Data Input.	
37	Tx1-	Transmitter Inverted Data Input.	
38	GND	Module Ground.	
39	GND	Module Ground.	
40	Tx6-	Transmitter Inverted Data Input.	
41	Tx6+	Transmitter Non-Inverted Data Input.	
42	GND	Module Ground.	
43	Tx8-	Transmitter Inverted Data Input.	
44	Tx8+	Transmitter Non-Inverted Data Input.	
45	GND	Module Ground.	
46	Reserved.	Not Connected.	
47	NC	Not Connected.	
48	VccRx1	+3.3V DC Power Supply.	
49	NC	Not Connected.	
50	NC	Not Connected.	
51	GND	Module Ground.	
52	Rx7+	Receiver Non-Inverted Differential Output.	
53	Rx7-	Receiver Inverted Differential Output.	
54	GND	Module Ground.	
55	Rx5+	Receiver Non-Inverted Differential Output.	
56	Rx5-	Receiver Inverted Differential Output.	
57	GND	Module Ground.	
58	GND	Module Ground.	
59	Rx6-	Receiver Inverted Differential Output.	
60	Rx6+	Receiver Non-Inverted Differential Output.	
61	GND	Module Ground.	
62	Rx8-	Receiver Inverted Differential Output.	
63	Rx8+	Receiver Non-Inverted Differential Output.	
64	GND	Module Ground.	
65	NC	Not Connected.	
66	Reserved.	Not Connected.	
67	VccTx1	+3.3V DC Power Supply.	
68	Vcc2	+3.3V DC Power Supply.	
69	Reserved	Not Connected.	
70	GND	Module Ground.	
71	Tx7+	Transmitter Non-Inverted Data Input.	
72	Tx7-	Transmitter Inverted Data Input.	

73	GND	Module Ground.	
74	Tx5+	Transmitter Non-Inverted Data Input.	
75	Tx5-	Transmitter Inverted Data Input.	
76	GND	Module Ground.	

Electrical Pin-Out Details



Block Diagram



Electrical Interface

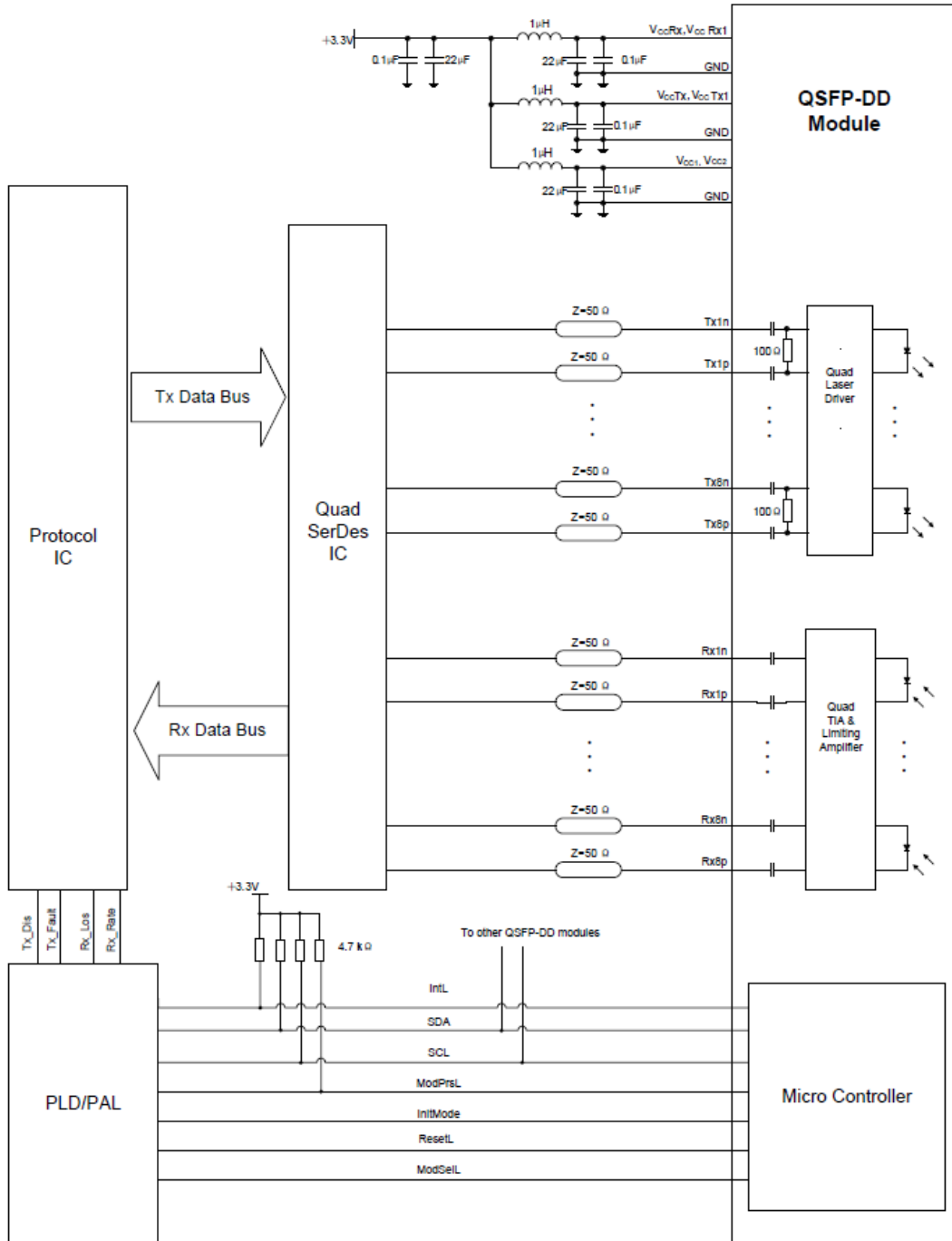

Mechanical Specifications



Notes:

1. Tolerance +/-0.1mm.
2. Others according with QSFP-DD MSA or customer specifications.
3. Light Port according with fiber connector specifications.
4. For cable lengths greater than 5m, the cable length tolerance is +4%/-0%.

About ProLabs

Our extensive experience comes as standard. For over 20 years ProLabs has delivered optical connectivity solutions that give our customers freedom and choice through our ability to provide seamless interoperability. At the heart of our company is the ability to provide state-of-the-art optical transport and connectivity solutions that are compatible with more than 100 optical switching and transport platforms.

A Complete Portfolio of Network Solutions

ProLabs is focused on innovations in optical transport and connectivity. The combination of our knowledge of optics and networking equipment enables ProLabs to be your single source for optical transport and connectivity solutions from 100Mb to 1.6T while providing innovative solutions that increase network efficiency. We provide the optical connectivity expertise that is compatible with and enhances your switching and transport equipment.

The Trusted Partner

Customer service is our number one value. ProLabs has invested in people, labs and manufacturing capacity to ensure compatible products, and immediate answers to your questions. With Engineering and Manufacturing offices in the U.K. and U.S. augmented by field offices throughout the U.S., U.K. and Asia, ProLabs is able to be our customers best advocate 24 hours a day.



Contact Information

ProLabs US

Email: sales@prolabs.com

Telephone: 952-852-0252

ProLabs UK

Email: salessupport@prolabs.com

Telephone: +44 1285 719 600