

SFP-2-5GB-DW45-160-C-OPC

Cisco® Compatible TAA 2.5GBase-DWDM SFP Transceiver C-Band 100GHz (SMF, 1541.35nm, 160km, LC, DOM)

Features

- INF-8074 and SFF-8472 Compliance
- Duplex LC Connector
- Single-mode Fiber
- Commercial Temperature 0 to 70 Celsius
- Hot Pluggable
- Metal with Lower EMI
- Excellent ESD Protection
- RoHS Compliant and Lead Free



Applications:

- Gigabit Ethernet over DWDM
- 1x Fibre Channel
- Access, Metro and Enterprise

Product Description

This Cisco® compatible SFP transceiver provides 2.5GBase-DWDM throughput up to 160km over single-mode fiber (SMF) using a wavelength of 1541.35nm via an LC connector. Our transceiver is built to meet or exceed OEM specifications and is guaranteed to be 100% compatible with Cisco®. It has been programmed, uniquely serialized, and tested for data-traffic and application to ensure that it will initialize and perform identically. All of our transceivers comply with Multi-Source Agreement (MSA) standards to provide seamless network integration. Additional product features include Digital Optical Monitoring (DOM) support which allows access to real-time operating parameters. This transceiver is Trade Agreements Act (TAA) compliant. We stand behind the quality of our products and proudly offer a limited lifetime warranty.

OptioConnect's transceivers are RoHS compliant and lead-free.

SFP+ Channel Number and Wavelength

Channel	Frequency	Center Wavelength (nm)	Channel	Frequency (THz)	Center Wavelength (nm)
0	190.0	1577.86	50	195.0	1537.40
1	190.1	1577.03	51	195.1	1536.61
2	190.2	1576.20	52	195.2	1535.82
3	190.3	1575.37	53	195.3	1535.04
4	190.4	1574.54	54	195.4	1534.25
5	190.5	1573.71	55	195.5	1533.47
6	190.6	1572.89	56	195.6	1532.68
7	190.7	1572.06	57	195.7	1531.90
8	190.8	1571.24	58	195.8	1531.12
9	190.9	1570.42	59	195.9	1530.33
10	191.0	1569.59	60	196.0	1529.55
11	191.1	1568.77	61	196.1	1528.77
12	191.2	1567.95	62	186.2	1610.06
13	191.3	1567.13	63	186.3	1609.19
14	191.4	1566.31	64	186.4	1608.33
15	191.5	1565.50	65	186.5	1607.47
16	191.6	1564.68	66	186.6	1606.60
17	191.7	1563.86	67	186.7	1605.74
18	191.8	1563.05	68	186.8	1604.88
19	191.9	1562.23	69	186.9	1604.03
20	192.0	1561.42	70	187.0	1603.17
21	192.1	1560.61	71	187.1	1602.31
22	192.2	1559.79	72	187.2	1601.46
23	192.3	1558.98	73	187.3	1600.60
24	192.4	1558.17	74	187.4	1599.75
25	192.5	1557.36	75	187.5	1598.89
26	192.6	1556.55	76	187.6	1598.04
27	192.7	1555.75	77	187.7	1597.19
28	192.8	1554.94	78	187.8	1596.34
29	192.9	1554.13	79	187.9	1595.49
30	193.0	1553.33	80	188.0	1594.64
31	193.1	1552.52	81	188.1	1593.79
32	193.2	1551.72	82	188.2	1592.95
33	193.3	1550.92	83	188.3	1592.10
34	193.4	1550.12	84	188.4	1591.26
35	193.5	1549.32	85	188.5	1590.41
36	193.6	1548.51	86	188.6	1589.57
37	193.7	1547.72	87	188.7	1588.73
38	193.8	1546.92	88	188.8	1587.88
39	193.9	1546.12	89	188.9	1587.04
40	194.0	1545.32	90	189.0	1586.20

41	194.1	1544.53	91	189.1	1585.36
42	194.2	1543.73	92	189.2	1584.53
43	194.3	1542.94	93	189.3	1583.69
44	194.4	1542.14	94	189.4	1582.85
45	194.5	1541.35	95	189.5	1582.02
46	194.6	1540.56	96	189.6	1581.18
47	194.7	1539.77	97	189.7	1580.35
48	194.8	1538.98	98	189.8	1579.52
49	194.9	1538.19	99	189.9	1578.69

Absolute Maximum Ratings

Parameter	Symbol	Min.	Typ.	Max.	Unit
Maximum Supply Voltage	Vcc	-0.5		3.6	V
Storage Temperature	Tstg	-40		85	°C
Operating Case Temperature	Tc	0		70	°C
Operating Humidity	RH			95	%
Data Rate	GBE		1.25		Gbps
	FC		1.063		

Electrical Characteristics

Parameter	Symbol	Min.	Typ.	Max.	Unit	Notes
Power Supply Voltage	Vcc	3.15	3.3	3.45	V	
Power Supply Current	Icc			450	mA	
Transmitter						
CML Differential Inputs	VIN	400		1600	mVp-p	AC Coupled Inputs
Input Differential Impedance	ZIN	85	100	115	Ω	RIN>100kΩ @ DC
Tx_Disable	Disable	2		Vcc	V	
	Enable	0		0.8		
Tx_Fault	Fault	2		Vcc	V	
	Normal	0		0.8		
Receiver						
CML Differential Outputs	VOUT	400	800	1200	mVp-p	AC Coupled Outputs
Output Impedance	ZOUT	85	100	115	Ω	
Rx_LOS	LOS	2		Vcc	V	
	Normal	0		0.8	V	
MOD-DEF (0:2)	VOH	2.5			V	
	VOL	0		0.8	V	

Optical Characteristics

Parameter	Symbol	Min.	Typ.	Max.	Unit	Notes
Transmitter						
Optical Center Wavelength	λ_C	1528		1610	nm	
Spectral Width (-20dB)	$\Delta\lambda$			0.3	nm	
Side-Mode Suppression Ratio	SMSR	30			dB	
Channel Spacing	Δf		100		GHz	
Deviation From Central Frequency @ EOL		-12		12	GHz	
Average Output Power	POUT	2		5	dBm	1
Average Launch Power (Tx Off)	Poff			-45	dBm	
Extinction Ratio	ER	8.2			dB	1
Rise/Fall Time (20-80%)	T_r/T_f			150	ps	
Tx_Disable Assert Time	Toff			10	us	
POUT @ Tx_Disable Asserted	POUT			-45	dBm	
Optical Signal Noise Ratio @ 0.1nm	OSNR		40		dB	3
Relative Intensity Noise	RIN			-135	dB/Hz	
Dispersion Tolerance	DT		2400		Ps/nm	
Output Optical Eye	Compatible with IEEE 802.3					1, 4
Receiver						
Optical Input Wavelength	λ	1528		1620	nm	
Receiver Sensitivity	Pmin			-31	dBm	2
Receiver Overload	Pmax	-9			dBm	
LOS De-Assert	LOSD			-32	dBm	
LOS Assert	LOSA	-45			dBm	
LOS Hysteresis			0.5		dB	5

Notes:

1. Filtered. Measured with a PRBS $2^{23}-1$ test pattern at 2.5Gbps.
2. Measured with a PRBS $2^{23}-1$ test pattern at 2.5Gbps, G.652 SMF, and BER $\leq 1 \times 10^{-12}$.
3. OSNR at BER of $10e^{-12}$.
4. Eye Pattern Mask.

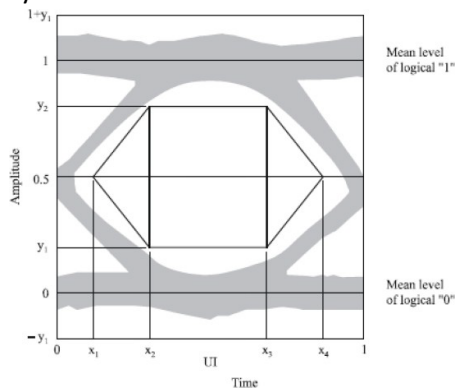

5. LOS Hysteresis.

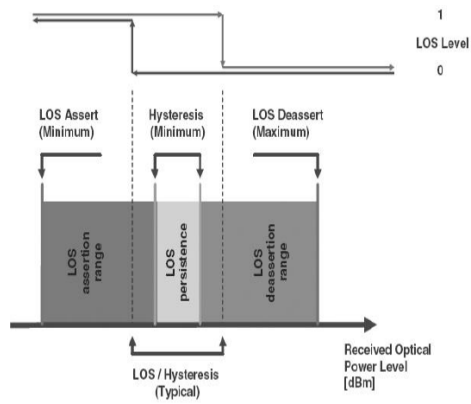

Pin Descriptions

Pin	Symbol	Name/Description	Note
1	VeeT	Transmitter Ground.	
2	Tx_Fault	Transmitter Fault Indication. Open Collector/Drain Output.	
3	Tx_Disable	Transmitter Disable.	
4	MOD-DEF2	Module Definition 2. 2-Wire Serial Interface Data.	
5	MOD-DEF1	Module Definition 1. 2-Wire Serial Interface Clock.	
6	MOD-DEF0	Module Definition 0. Grounded within the module.	
7	Rate Select	Rate Select 0. Not Used.	
8	LOS	Loss of Signal. Open Collector/Drain Output.	
9	VeeR	Receiver Ground.	
10	VeeR	Receiver Ground.	
11	VeeR	Receiver Ground.	
12	RD-	Inverted Receiver Data Out.	
13	RD+	Received Data Out.	
14	VeeR	Receiver Ground.	
15	VccR	Receiver Power. 3.3 ± 5%.	
16	VccT	Transmitter Power. 3.3 ± 5%.	
17	VeeT	Transmitter Ground.	
18	TD+	Transmitter Data In.	
19	TD-	Inverted Transmit Data In.	
20	VeeT	Transmitter Ground.	

Electrical Pad Layout

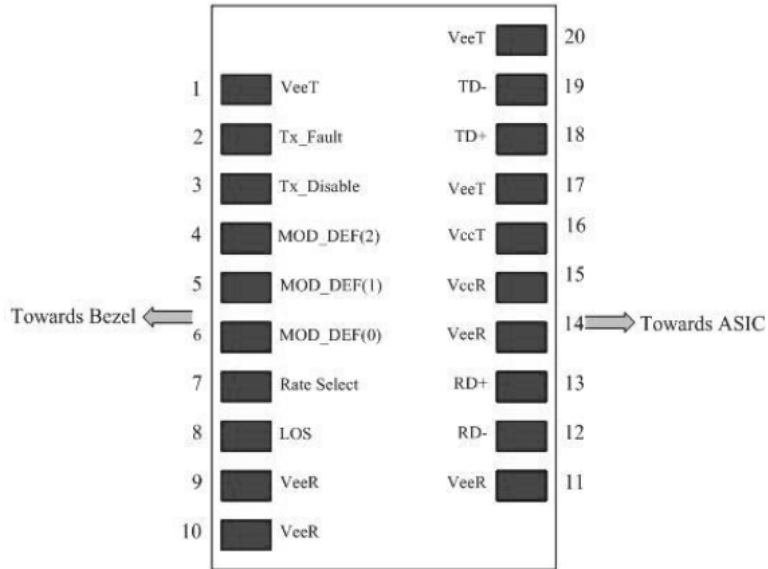
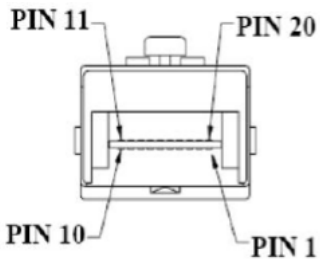

Recommended Circuit Schematic

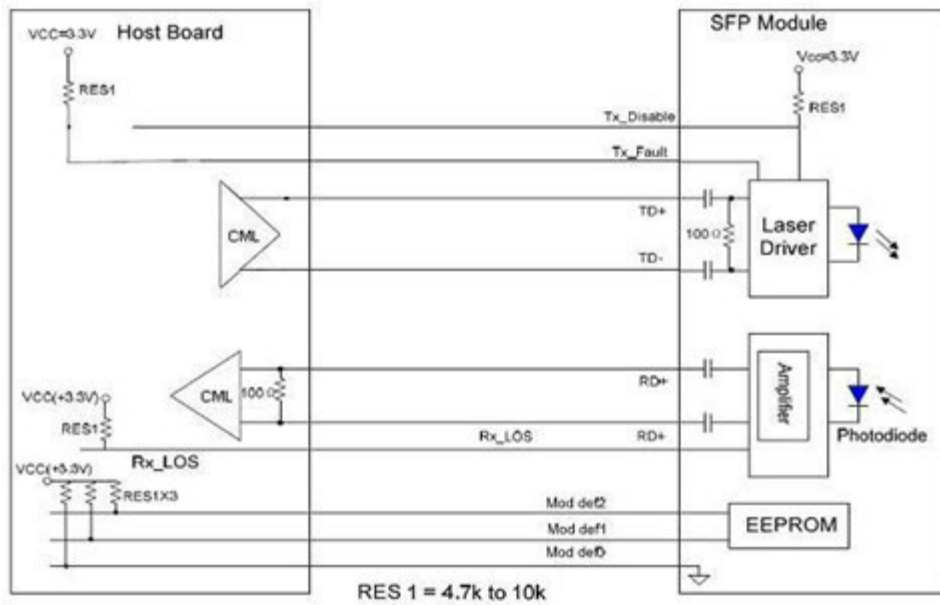

Functional Description of Transceiver

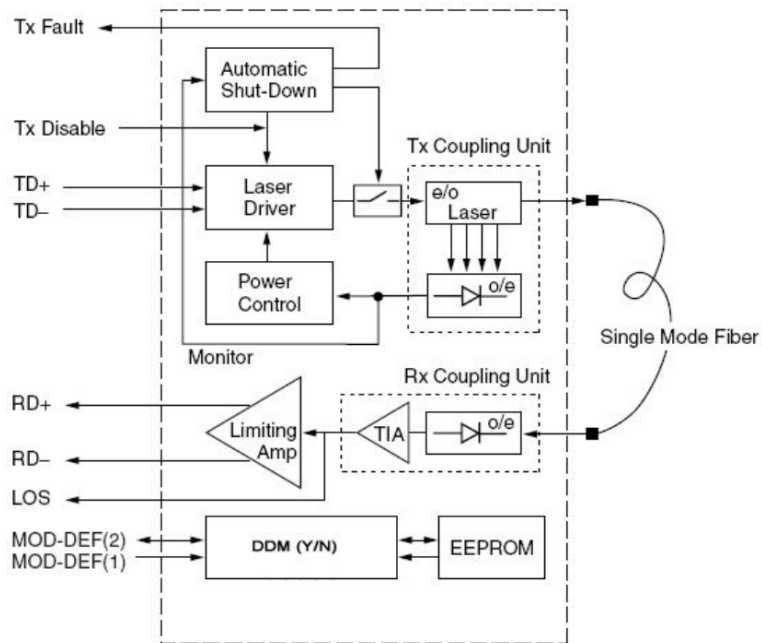

Mechanical Specifications

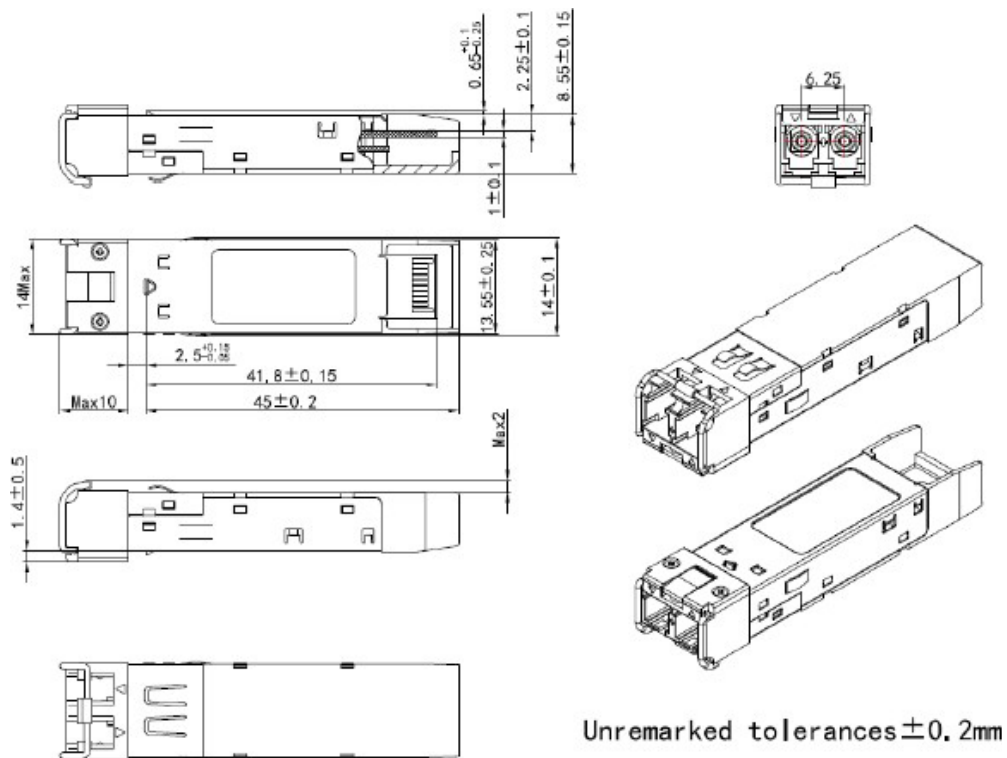

EEPROM Information

EEPROM memory map-specific data field description is as below:

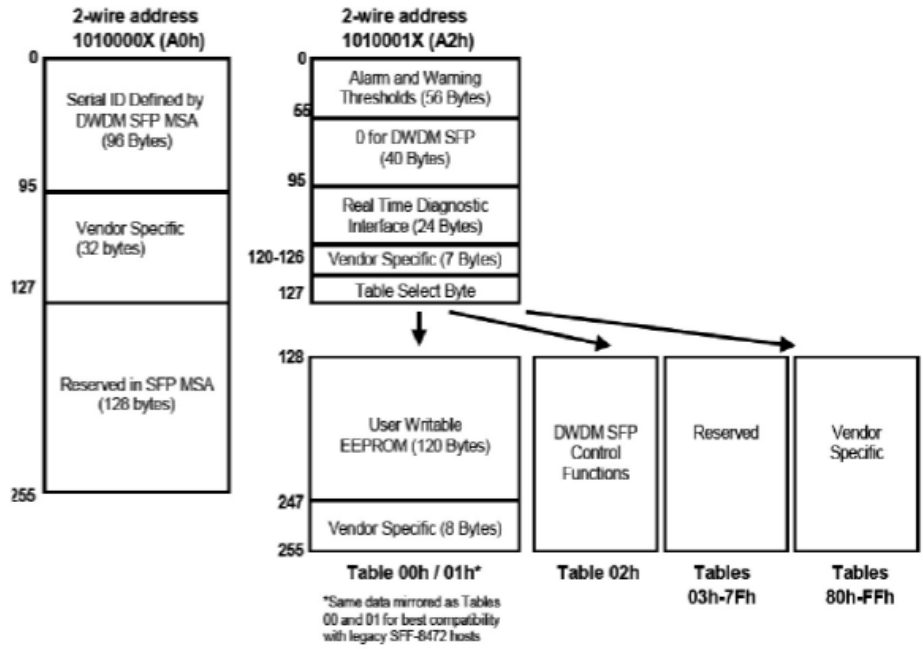

OptioConnect

Innovation for the Future of High-Speed Networking

Who We Are

OptioConnect is reshaping the landscape of communication and high-speed networking through intelligent technology. With a core focus on cutting edge technology, we deliver smarter fiber optic solutions for enterprise networks, data centers, and next-gen telecom infrastructures.

What We Do

At OptioConnect, we fuse advanced engineering with intelligent automation to drive the future of networking. Our AI-integrated solutions are designed to optimize performance and streamline operations with:

- Superior Performance
- Network and traffic optimization
- Intelligent energy management
- Seamless OEM compatibility
- Scalable cost-efficiency

Smarter Networks by Design

Innovation isn't just a goal—it's our process. We embed AI and machine learning across our R&D and product lines, enabling adaptive performance, automated tuning, and faster deployment cycles. The result? Networks that don't just work—they learn, evolve, and outperform.

Our Team

Our engineers, data scientists, and network architects bring decades of experience and a future-focused mindset. We provide hands-on support with intelligent insights that turn complex challenges into simple solutions.

Our Mission

To deliver AI-enhanced connectivity that reduces cost, increases speed, and maximizes efficiency—empowering our partners to operate at the forefront of a rapidly evolving digital world.

Let's Connect

Discover how OptioConnect's intelligent infrastructure solutions can power your network's next leap forward.

www.optioconnect.com | info@optioconnect.com

