

QDD-2X400G-FR4-C

Cisco® QDD-2X400G-FR4 Compatible TAA 800GBase-2xFR4 QSFP-DD Transceiver (SMF, 1310nm, 2km, 2xLC, DOM, 0 to 70C, CMIS 5.0)

Features:

- Compliant with IEEE 802.3cu-2021: 2x400GBASE-FR4 Optical Interface
- Compliant with IEEE P802.3ck D3.0- 2x400GAUI-4 C2M Electrical Interface
- Dual LC Connectors
- CMIS 5.0 Compliant
- 800 QSFP-DD MSA Compliant
- Class 1 Laser Safety Certified
- Operating Temperature: 0 to 70 Celsius
- RoHS Compliant and Lead-Free

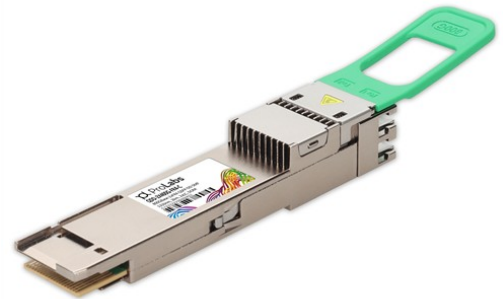

Applications:

- 2x400GBase Ethernet

Product Description

This Cisco® compatible transceiver QSFP-DD transceiver provides 800GBase-2xFR4 throughput up to 2km over single-mode fiber (SMF) PAM4 using a wavelength of 1310nm via a 2xLC connector. It can operate at temperatures between 0 and 70C. All of our transceivers are built to comply with Multi-Source Agreement (MSA) standards and are uniquely serialized and tested for data-traffic and application to ensure seamless network integration. Additional product features include Digital Optical Monitoring (DOM) support which allows access to real-time operating parameters. This transceiver is Trade Agreements Act (TAA) compliant. We stand behind the quality of our products and proudly offer a limited lifetime warranty.

ProLabs' transceivers are RoHS compliant and lead-free.

TAA refers to the Trade Agreements Act (19 U.S.C. & 2501-2581), which is intended to foster fair and open international trade. TAA requires that the U.S. Government may acquire only "U.S.-made or designated country end products.")



Absolute Maximum Ratings

Parameter	Symbol	Min.	Typ.	Max.	Unit	Notes
Storage Temperature	Tstg	-40		85	°C	
Operating Case Temperature	Tc	0	25	70	°C	
Supply Voltage	Vcc	-0.5		3.6	V	
Relative Humidity	RH	5		95	%	
Operating Distance		2		2000	m	
Signaling Speed Per Lane	DRL		53.125		GBd	
Maximum Power Dissipation	PD			17	W	
Maximum Power Dissipation (Low-Power Mode)	PDLP			2	W	

Electrical Characteristics

Parameter	Symbol	Min.	Typ.	Max.	Unit	Notes
Power Supply Voltage	Vcc	3.135	3.3	3.465	V	
Data Input Voltage Differential	IVdip-Vdinl			1	V	
Control Input Voltage	VI	-0.3		Vcc+0.5	V	
Control Output Current	IO	-20		20	mA	
Instantaneous Peak Current at Hot Plug	Icc_IP			6800	mA	
Sustained Peak Current at Hot Plug	Icc_SP			5611	mA	
Control Input Voltage High	VIH	Vcc*0.7		Vcc+0.3	V	
Control Input Voltage Low	VIL	-0.3		Vcc*0.3	V	
2-Wire Serial Interface Clock Rate				400	kHz	
Power Supply Noise 1kHz - 1MHz (Pk-Pk)				66	mVp-p	
Power Supply Current	Icc			3.8	A	
Power Dissipation	PDISS			12	W	
Transmitter - Module Input, TP1						
Differential Pk-Pk Input Voltage Tolerance (TP1a)		750			mV	
AC Common-Mode RMS Voltage Tolerance (TP1a)		25			mV	
Effective Return Loss	ERL	8.5			dB	
Differential Termination Mismatch				10	%	
Single-Ended Voltage Tolerance Range		-0.4		3.3	V	
DC Common-Mode Voltage Tolerance		-0.35		2.85	V	
Differential-Mode to Common-Mode Return Loss	RLcd		802.3ck 120G-2		dB	
Receiver - Module Output, TP4						
AC Common-Mode Output Voltage (RMS)				25	mV	

Differential Pk-Pk Output Voltage	Long-Mode				600	mV	
	Short-Mode				845		
Eye Height	EH	15				mV	
Vertical Eye Closure	VEC				12	dB	
Effective Return Loss	ERL	8.5				dB	
Differential Termination Mismatch					10	%	
Transition Time		8.5				ps	
DC Common-Mode Voltage Tolerance		-0.35			2.85	V	
Common-Mode to Differential-Mode Return Loss	RLDc	802.3ck 120G-1				dB	
Low-Speed Control and Sense Signals							
Module Output SCL and SDA	VOL	0			0.4	V	
Module Input SCL and SDA	VIL	-0.3			Vcc*0.3	V	
	VIH	Vcc*0.7			Vcc+0.5	V	
InitMode, ResetL, and ModSelL	VIL	-0.3			0.8	V	
	VIH	2			Vcc+0.3	V	
IntL	VOL	0			0.4	V	
	VOH	Vcc-0.5			Vcc+0.3	V	

Optical Characteristics

Parameter	Symbol	Min.	Typ.	Max.	Unit	Notes	
Transmitter							
Center Wavelength	L0, L4	λ_C	1264.5	1271	1277.5	nm	
	L1, L5		1284.5	1291	1297.5		
	L2, L6		1304.5	1311	1317.5		
	L3, L7		1324.5	1331	1337.5		
Side-Mode Suppression Ratio	SMSR	30			dB		
Total Average Launch Power	PT			10.4	dBm		
Average Launch Power Per Lane	P	-3.2		4.4	dBm	1	
Outer Optical Modulation Amplitude (OMA _{outer}) Per Lane	TDECQ < 1.4dB	Toma	-0.2		3.7		
	1.4dB ≤ TDECQ ≤ 3.4dB		-1.6+TDECQ				
Difference in Launch Power Between Any Two Lanes (OMA _{outer})	AOPd			3.9	dB		
Transmitter and Dispersion Eye Closure for PAM4 (TDECQ) Per Lane	TDECQ			3.4	dB		
Transmitter Eye Closure for PAM4 (TECQ) Per Lane	TECQ			3.4	dB		
TDECQ-TECQ				2.5	dB		
Over/Under-Shoot				22	%		

Transmitter Power Excursion					1.8	dBm	
Average Launch Power of Off Transmitter Per Lane		T _{off}			-16	dBm	
Extinction Ratio		ER	3.5			dB	
Maximum Transmitter Transition Time					17	ps	
RIN_{17.1}OMA (Maximum)		RIN			-136	dB/Hz	
Optical Return Loss Tolerance		ORLT			17.1	dB	
Transmitter Reflectance		TR			-26	dB	2
Receiver							
Center Wavelength	L0, L4	λ_C	1264.5	1271	1277.5	nm	
	L1, L5		1284.5	1291	1297.5		
	L2, L6		1304.5	1311	1317.5		
	L3, L7		1324.5	1331	1337.5		
Damage Threshold Per Lane			-5.4			dBm	
Average Receiver Power Per Lane		P _{avg}	-7.2		4.4	dBm	
Receive Power Per Lane (OMA_{outer})					3.7	dBm	
Difference in Receive Power Between Any Two Lanes (OMA_{outer}) (Maximum)					4.1	dB	
Receiver Reflectance		RR			-26	dB	
Receiver Sensitivity Per Lane (OMA_{outer})	TDECQ < 1.4dB	SOMA			-4.6	dBm	
	1.4dB ≤ TDECQ ≤ 3.4dB				-6+TECQ		
Stressed Receiver Sensitivity Per Lane (OMA_{outer})		SRS			-2.6	dBm	3
Conditions of Stressed Receiver Sensitivity Test							
Stressed Eye Closure for PAM4 (SECQ) Per Lane Under Test				3.4		dB	
OMA_{outer} of Each Aggressor Lane				1.4		dBm	

Notes:

1. Average launch power per lane (minimum) is informative and not the principal indicator of signal strength.
2. Transmitter reflectance is defined looking into the transmitter.
3. Measured with conformance test signals at TP3 for the BER=2.4x10⁻⁴.

Pin Descriptions

Pin	Logic	Symbol	Name/Description	Notes
1		GND	Module Ground.	
2	CML-I	Tx2-	Transmitter Inverted Data Input.	
3	CML-I	Tx2+	Transmitter Non-Inverted Data Input.	
4		GND	Module Ground.	
5	CML-I	Tx4-	Transmitter Inverted Data Input.	
6	CML-I	Tx4+	Transmitter Non-Inverted Data Input.	
7		GND	Module Ground.	
8	LVTTTL-I	ModSelL	Module Select.	
9	LVTTTL-I	ResetL	Module Reset.	
10		VccRx	+3.3V Receiver Power Supply.	
11	LVC MOS-I/O	SCL	2-Wire Serial Interface Clock.	
12	LVC MOS-I/O	SDA	2-Wire Serial Interface Data.	
13		GND	Module Ground.	
14	CML-O	Rx3+	Receiver Non-Inverted Data Output.	
15	CML-O	Rx3-	Receiver Inverted Data Output.	
16		GND	Module Ground.	
17	CML-O	Rx1+	Receiver Non-Inverted Data Output.	
18	CML-O	Rx1-	Receiver Inverted Data Output.	
19		GND	Module Ground.	
20		GND	Module Ground.	
21	CML-O	Rx2-	Receiver Inverted Data Output.	
22	CML-O	Rx2+	Receiver Non-Inverted Data Output.	
23		GND	Module Ground.	
24	CML-O	Rx4-	Receiver Inverted Data Output.	
25	CML-O	Rx4+	Receiver Non-Inverted Data Output.	
26		GND	Module Ground.	
27	LVTTTL-O	ModPrsL	Module Present.	
28	LVTTTL-O	IntL/RxLOS	Interrupt/Optional RxLOS.	
29		VccTx	+3.3V Transmitter Power Supply.	
30		Vcc1	+3.3V Power Supply.	
31	LVTTTL-I	LPMoDe/TxDis	Low-Power Mode/Optional Tx_Disable.	
32		GND	Module Ground.	
33	CML-I	Tx3+	Transmitter Non-Inverted Data Input.	
34	CML-I	Tx3-	Transmitter Inverted Data Input.	
35		GND	Module Ground.	
36	CML-I	Tx1+	Transmitter Non-Inverted Data Input.	
37	CML-I	Tx1-	Transmitter Inverted Data Output.	
38		GND	Module Ground.	
39		GND	Module Ground.	
40	CML-I	Tx6-	Transmitter Inverted Data Input.	

41	CML-I	Tx6+	Transmitter Non-Inverted Data Input.	
42		GND	Module Ground.	
43	CML-I	Tx8-	Transmitter Inverted Data Input.	
44	CML-I	Tx8+	Transmitter Non-Inverted Data Input.	
45		GND	Module Ground.	
46	LVC MOS/CML-I	P/VS4	Programmable/Module Vendor-Specific 4.	
47	LVC MOS/CML-I	P/VS1	Programmable/Module Vendor-Specific 1.	
48		VccRx1	+3.3V Receiver Power Supply.	
49	LVC MOS/CML-O	P/VS2	Programmable/Module Vendor-Specific 2.	
50	LVC MOS/CML-O	P/VS3	Programmable/Module Vendor-Specific 3.	
51		GND	Module Ground.	
52	CML-O	Rx7+	Receiver Non-Inverted Data Output.	
53	CML-O	Rx7-	Receiver Inverted Data Output.	
54		GND	Module Ground.	
55	CML-O	Rx5+	Receiver Non-Inverted Data Output.	
56	CML-O	Rx5-	Receiver Inverted Data Output.	
57		GND	Module Ground.	
58		GND	Module Ground.	
59	CML-O	Rx6-	Receiver Inverted Data Output.	
60	CML-O	Rx6+	Receiver Non-Inverted Data Output.	
61		GND	Module Ground.	
62	CML-O	Rx8-	Receiver Inverted Data Output.	
63	CML-O	Rx8+	Receiver Non-Inverted Data Output.	
64		GND	Module Ground.	
65		NC	Not Connected.	
66		Reserved		
67		VccTx1	+3.3V Transmitter Power Supply.	
68		Vcc2	+3.3V Power Supply.	
69	LVC MOS-I	ePPS/Clock	1PPS Precision Time Protocol (PTP) Reference Clock Input.	
70		GND	Module Ground.	
71	CML-I	Tx7+	Transmitter Non-Inverted Data Input.	
72	CML-I	Tx7-	Transmitter Inverted Data Input.	
73		GND	Module Ground.	
74	CML-I	Tx5+	Transmitter Non-Inverted Data Input.	
75	CML-I	Tx5-	Transmitter Inverted Data Input.	
76		GND	Module Ground.	

Module Pad Layout

Top PCB viewed from top

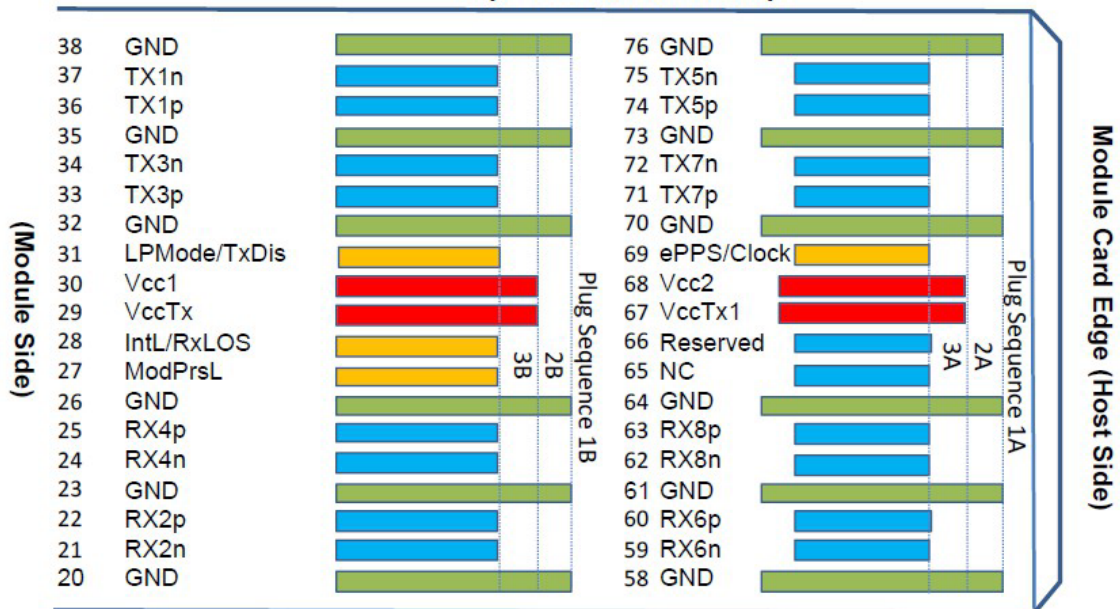

Bottom PCB viewed from bottom

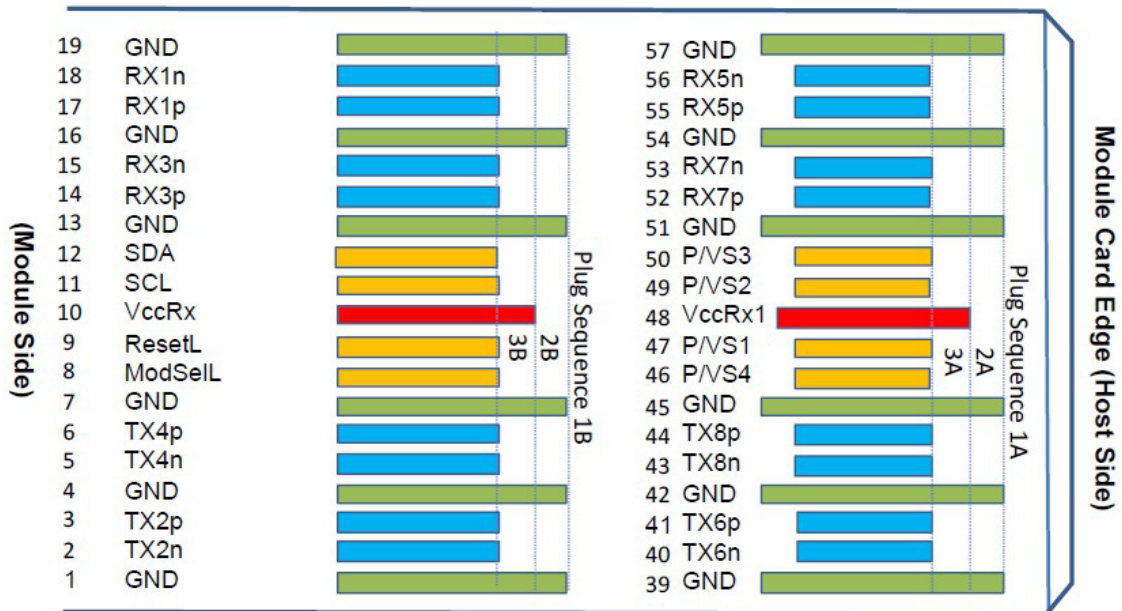

Classic
QSFP+/QSFP28/QSFP112 Pads

Additional
QSFP-DD/QSFP-DD800 Pads

Host Board

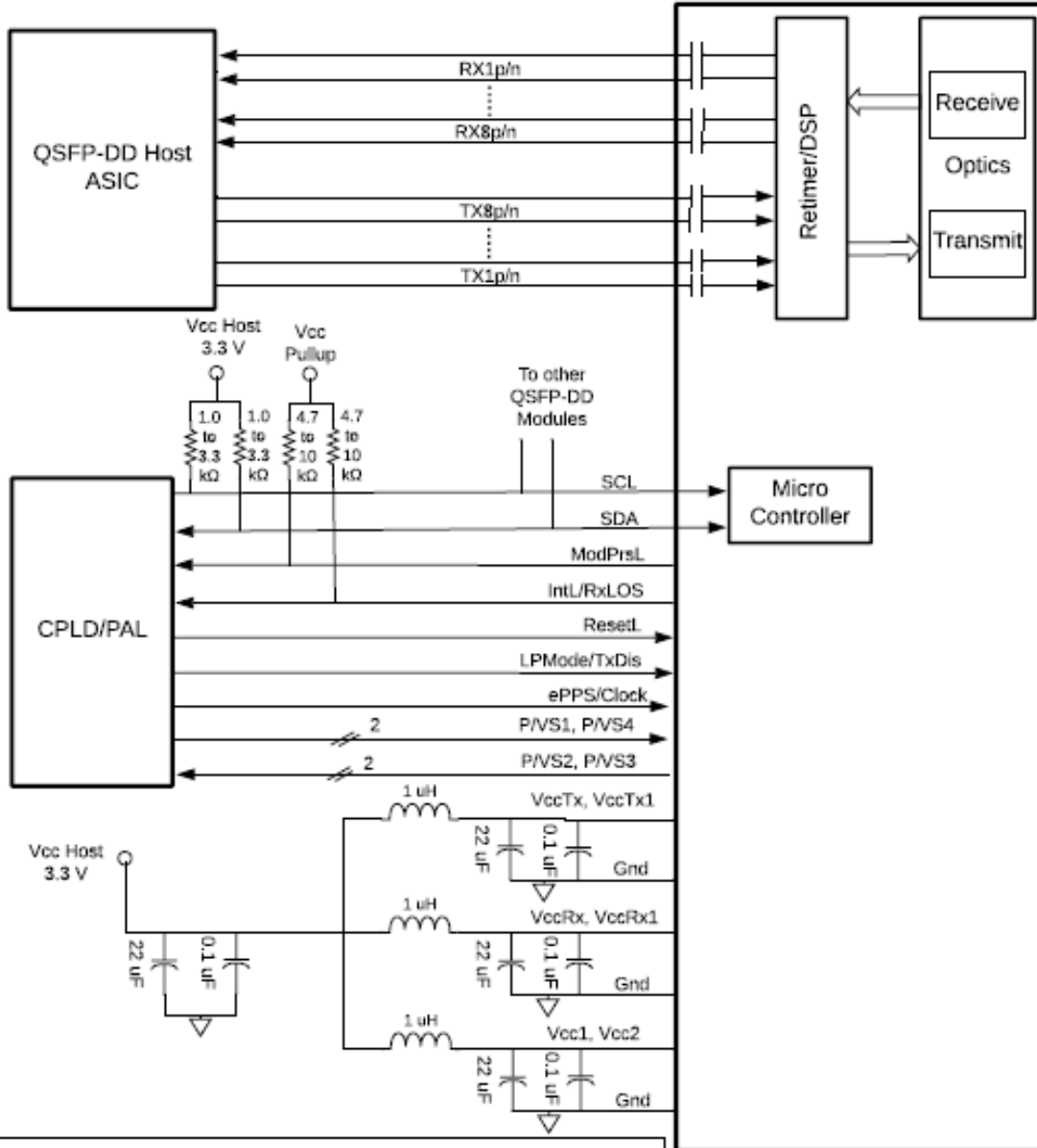

Note: Filter capacitors values are informative and application dependent, 0.1 μF capacitors should be placed in close proximity to power pads and may be duplicated for individual pads to provide additional high frequency filtering.

Note: Vcc1/Vcc2 may be connected to VccTx/VccTx1 or VccRx/VccRx1 within the module provided the applicable derating of the maximum current limit is used.

**QSFP-DD/QSFP-DD800
Optical Module**

Mechanical Specifications

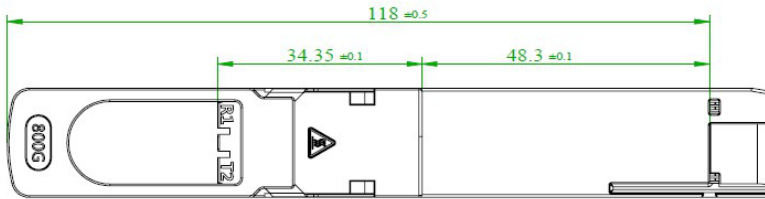
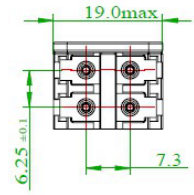
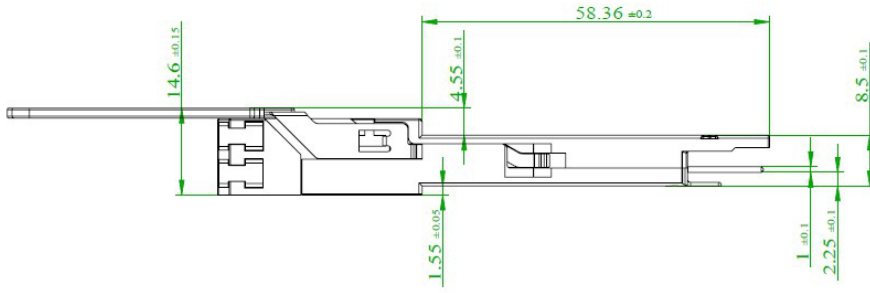
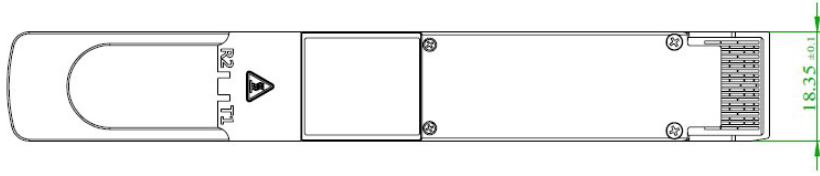

About ProLabs

Our extensive experience comes as standard. For over 20 years ProLabs has delivered optical connectivity solutions that give our customers freedom and choice through our ability to provide seamless interoperability. At the heart of our company is the ability to provide state-of-the-art optical transport and connectivity solutions that are compatible with more than 100 optical switching and transport platforms.

A Complete Portfolio of Network Solutions

ProLabs is focused on innovations in optical transport and connectivity. The combination of our knowledge of optics and networking equipment enables ProLabs to be your single source for optical transport and connectivity solutions from 100Mb to 1.6T while providing innovative solutions that increase network efficiency. We provide the optical connectivity expertise that is compatible with and enhances your switching and transport equipment.

The Trusted Partner

Customer service is our number one value. ProLabs has invested in people, labs and manufacturing capacity to ensure compatible products, and immediate answers to your questions. With Engineering and Manufacturing offices in the U.K. and U.S. augmented by field offices throughout the U.S., U.K. and Asia, ProLabs is able to be our customers best advocate 24 hours a day.



Contact Information

ProLabs US

Email: sales@prolabs.com

Telephone: 952-852-0252

ProLabs UK

Email: salessupport@prolabs.com

Telephone: +44 1285 719 600