

QSFP-4X10G-AOC15M-AO

Cisco® QSFP-4X10G-AOC15M Compatible TAA Compliant 40GBase-AOC QSFP+ to 4xSFP+ Active Optical Cable (850nm, MMF, 15m)

Features

- 850nm VCSEL transmitter, PIN photo-detector receiver
- Electrical interface compliant to QSFP+ connector (SFF-8436) and SFP+ connectors (SFF-8431)
- All-metal housing for superior EMI performance
- Operating temperature: 0 to 70 Celsius
- RoHS compliant and Lead free
- Hot Pluggable



Applications

- Fiber Channel Application
- 40GBase Ethernet
- InfiniBand QDR, SDR, DDR
- Servers, switches, storage, and host card adapters

Product Description

This is a Cisco® QSFP-4X10G-AOC15M Compatible 40GBase-AOC QSFP+ to 4xSFP+ active optical cable that operates over active fiber with a maximum reach of 15m. It has been programmed, uniquely serialized, and data-traffic and application tested to ensure it is 100% compliant and functional. We stand behind the quality of our products and proudly offer a limited lifetime warranty. This cable is TAA (Trade Agreements Act) compliant and is built to comply with MSA (Multi-Source Agreement) standards.

AddOn's transceivers are RoHS compliant and lead-free.

TAA refers to the Trade Agreements Act (19 U.S.C. & 2501-2581), which is intended to foster fair and open international trade. TAA requires that the U.S. Government may acquire only "U.S. – made or designated country end products."



QSFP Interface Specifications

Parameter	Description
Module Form Factor	QSFP+ (Supports SFF-8436/SFF-8472)
Channel Data Rate	Rate 40Gbps
BER	$<10^{-12}$
Operating Case Temperature	0 °C to 70°C
Storage Temperature	-20 °C to 85°C
Supply Voltage	3.3V
Supply Current	180mA Per End Typical
Management Interface Serial	I ² C (Supports SFF-8472)

Optical Characteristics

Parameter	Symbol	Min.	Typ.	Max.	Unit	Notes
Transmitter						
Center Wavelength	λ_C	840	850	860	nm	
RMS Spectral Width	$\Delta\lambda$			0.65	nm	
Average Launch Power Per Lane	POUT	-7.5		-2.5	dBm	
Difference in Launch Power Between Any Two Lanes (OMA)					dB	
Extinction Ratio	ER	3			dB	
Peak Power Per Lane				4	dBm	
Transmitter and Dispersion Penalty (TDP) Per Lane	TDP			3.5	dB	
Average Launch Power of Off Transmitter Per Lane				-30	dB	
Eye Mask Coordinates: (X1, X2, X3, Y1, Y2, Y3)		(0.23, 0.34, 0.43, 0.27, 0.33, 0.4)				Hit Ratio = 5×10^{-5}
Receiver						
Center Wavelength	λ_C	840	850	860	nm	
Stressed Receiver Sensitivity in OMA Per Lane				-5.4		1
Maximum Average Power at Receiver Input Per Lane				2.4		
Receiver Reflectance				-12		
Peak Power Per Lane				4		
LOS Assert		-30				
LOS De-Assert – OMA				7.5		
LOS Hysteresis		0.5				

Notes:

1. Measured with conformance test signal at TP3 for BER= $10E^{-12}$.

SFP+ Interface Specifications

Parameter	Description
Module Form Factor	SFP+ (Supports SFF8431/SFF8432/SFF8472)
Channel Data Rate	Rate 1 to 10.3125Gbps
BER	$<10^{-12}$
Operating Case Temperature	0 to 70°C
Storage Temperature	-20 to 85°C
Supply Voltage	3.3V
Supply Current	455mA Maximum
Management Interface Serial	I ² C (Supports SFF-8472)

Optical Characteristics

Parameter	Symbol	Min.	Typ.	Max.	Unit	Notes
Transmitter						
Center Wavelength	λ_C	840	850	860	nm	
RMS Spectral Width	$\Delta\lambda$			Note 1	nm	
Average Optical Power	P_{avg}	-6.5		-1	dBm	2
Extinction Ratio	ER	3.5			dB	3
Transmitter Dispersion Penalty	TDP			3.9	dB	
Relative Intensity Noise	RIN			-128	dB/Hz	-12B Reflection
Optical Return Loss Tolerance				12	dB	
Receiver						
Center Wavelength	λ_C	840	850	860	nm	
Receiver Sensitivity	P_{sens}			-11.1	dBm	4
Stressed Sensitivity in OMA				-7.5	dBm	4
LOS Function	LOS	-30		-12	dBm	
Overload	P_{in}			-1.0	dBm	4
Receiver Reflectance				-12	dB	

Notes:

1. Trade-offs are available between spectral width, center wavelength, and minimum OMA.
2. The optical power is launched into MMF.
3. Measured with a PRBS $2^{31}-1$ test pattern @10.3125Gbps.
4. Measured with a PRBS $2^{31}-1$ test pattern @10.3125Gbps and $BER \leq 10^{-12}$.

Mechanical Specifications

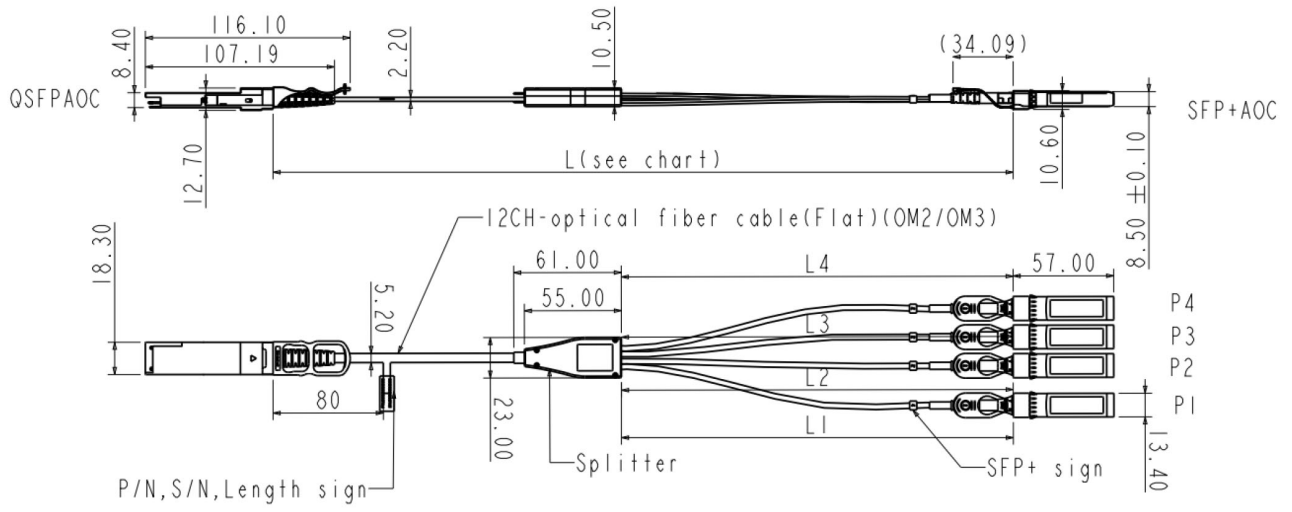

About AddOn Networks

In 1999, AddOn Networks entered the market with a single product. Our founders fulfilled a severe shortage for compatible, cost-effective optical transceivers that compete at the same performance levels as leading OEM manufacturers. Adhering to the idea of redefining service and product quality not previously had in the fiber optic networking industry, AddOn invested resources in solution design, production, fulfillment, and global support.

Combining one of the most extensive and stringent testing processes in the industry, an exceptional free tech support center, and a consistent roll-out of innovative technologies, AddOn has continually set industry standards of quality and reliability throughout its history.

Reliability is the cornerstone of any optical fiber network and is engrained in AddOn's DNA. It has played a key role in nurturing the long-term relationships developed over the years with customers. AddOn remains committed to exceeding industry standards with certifications from ranging from NEBS Level 3 to ISO 9001:2005 with every new development while maintaining the signature reliability of its products.



U.S. Headquarters

Email: sales@addonnetworks.com

Telephone: +1 877.292.1701

Fax: 949.266.9273

Europe Headquarters

Email: salesupportemea@addonnetworks.com

Telephone: +44 1285 842070