

CWDM-10G-1410-40-OPC

Cisco® CWDM-10G-1410-40 Compatible TAA 10GBase-CWDM SFP+ Transceiver (SMF, 1410nm, 40km, LC, DOM)

Features

- SFF-8432 and SFF-8472 Compliance
- Duplex LC Connector
- Single-mode Fiber
- Commercial Temperature 0 to 70 Celsius
- Hot Pluggable
- Metal with Lower EMI
- Excellent ESD Protection
- RoHS Compliant and Lead Free



Applications:

- 10x Gigabit Ethernet over CWDM
- 8x/10x Fibre Channel
- Access, Metro and Enterprise
- Mobile Fronthaul CPRI/OBSAI

Product Description

This Cisco® CWDM-10G-1410-40 compatible SFP+ transceiver provides 10GBase-CWDM throughput up to 40km over single-mode fiber (SMF) using a wavelength of 1410nm via an LC connector. It is guaranteed to be 100% compatible with the equivalent Cisco® transceiver. This easy to install, hot swappable transceiver has been programmed, uniquely serialized and data-traffic and application tested to ensure that it will initialize and perform identically. Digital optical monitoring (DOM) support is also present to allow access to real-time operating parameters. This transceiver is Trade Agreements Act (TAA) compliant. We stand behind the quality of our products and proudly offer a limited lifetime warranty.

OptioConnect's transceivers are RoHS compliant and lead-free.

TAA refers to the Trade Agreements Act (19 U.S.C. & 2501-2581), which is intended to foster fair and open international trade. TAA requires that the U.S. Government may acquire only "U.S.-made or designated country end products."



CWDM Available Wavelengths

Wavelengths	Min.	Typ.	Max.
27	1264.5	1271	1277.5
29	1284.5	1291	1297.5
31	1304.5	1311	1317.5
33	1324.5	1331	1337.5
35	1344.5	1351	1357.5
37	1364.5	1371	1377.5
39	1384.5	1391	1397.5
41	1404.5	1411	1417.5
43	1424.5	1431	1437.5
45	1444.5	1451	1457.5

Absolute Maximum Ratings

Parameter	Symbol	Min.	Typ.	Max.	Unit
Maximum Supply Voltage	Vcc	-0.5		3.6	V
Storage Temperature	Tstg	-40		85	°C
Operating Case Temperature	Tc	0		70	°C
Relative Humidity (Non-Condensing)	RH	0		85	%
Data Rate	DR	0.6	9.953/10.3125		Gbps

Notes:

1. Exceeding any one of these values may destroy the device immediately.

Electrical Characteristics

Parameter	Symbol	Min.	Typ.	Max.	Unit	Notes
Power Supply Voltage	V _{CC}	3.15	3.30	3.43	V	
Power Consumption	P _{DISS}			1.5	W	
Transmitter						
CML Differential Inputs	V _{IN}	150		1200	mVp-p	AC Coupled Inputs
Input AC Common-Mode Voltage		0		25	mV	RMS
Input Differential Impedance	Z _{IN}	85	100	115	Ω	R _{IN} >100kΩ @DC
Tx_Disable	High	2		V _{CC}	V	
	Low	0		0.8		
Tx_Fault	High	2		V _{CC} +0.3	V	I _o = 400μA; Host_V _{CC}
	Low	0		0.5		I _o = -4.0mA
Receiver						
CML Differential Outputs	V _{OUT}	350		700	mVp-p	AC Coupled Outputs
Output Differential Impedance	Z _{OUT}	85	100	115	Ω	
Rx_LOS	High	2		V _{CC} +0.3		I _o = 400μA; Host_V _{CC}
	Low	0		0.8		I _o = -4.0mA
MOD_DEF(0.2)	VOH	2.5			V	With Serial ID
	VOL	0		0.5	V	With Serial ID

Optical Characteristics

Parameter	Symbol	Min.	Typ.	Max.	Unit	Notes
Transmitter						
Center Wavelength	λ_C	$\lambda-6.5$	λ	$\lambda+6.5$	nm	
Average Output Power	POUT	0		6	dBm	1
Extinction Ratio	ER	3.5		dB	dB	
Average Power of Off Transmitter	P _{off}			-30	dBm	
Side-Mode Suppression Ratio	SMSR	30		dB		
-20dB Spectral Width	$\Delta\lambda$			1	nm	
Transmitter Dispersion Penalty	TDP			3	dB	
Relative Intensity Noise	RIN			-128	dB/Hz	
Tx_Disable Assert Time	T _{off}			10	us	
Receiver						
Center Wavelength	λ_C	1260		1620	nm	
Receiver Sensitivity	P _{min}			-15	dBm	2
Receiver Overload	P _{max}	0		dBm	nm	
LOS De-Assert	LOSD			-17	dBm	
LOS Assert	LOSA	-28		dBm		
LOS Hysteresis	LOSH	0.5		dB		

Notes:

1. Output is coupled into a 9/125 μ m SMF.
2. Measured with worst ER, BER less than $1E^{-12}$, and PRBS $2^{31}-1$ @10.3125Gbps.

Pin Descriptions

Pin	Symbol	Name/Description	Notes
1	VeeT	Transmitter Ground (Common with Receiver Ground).	1
2	Tx_Fault	Transmitter Fault. LVTTTL-O.	2
3	Tx_Disable	Transmitter Disable. Laser output disabled on “high” or “open.” LVTTTL-I.	3
4	SDA	2-Wire Serial Interface Data (Same as MOD-DEF2 in INF-8074i). LVTTTL-I/O.	
5	SCL	2-Wire Serial Interface Clock (Same as MOD-DEF2 in INF-8074i). LVTTTL-I.	
6	MOD_ABS	Module Absent. Connect to the VeeT or VeeR in the module.	4
7	RS0	Rate Select 0. Not Used.	5
8	LOS	Loss of Signal Indication. “Logic 0” indicates normal operation. LVTTTL-O.	2
9	RS1	Rate Select 1. Not Used.	5
10	VeeR	Receiver Ground (Common with Transmitter Ground).	1
11	VeeR	Receiver Ground (Common with Transmitter Ground).	1
12	RD-	Receiver Inverted Data Out. AC Coupled. CML-O.	
13	RD+	Receiver Non-Inverted Data Out. AC Coupled. CML-O.	
14	VeeR	Receiver Ground (Common with Transmitter Ground).	1
15	VccR	Receiver Power Supply.	
16	VccT	Transmitter Power Supply.	
17	VeeT	Transmitter Ground (Common with Receiver Ground).	1
18	TD+	Transmitter Non-Inverted Data In. AC Coupled. CML-I.	
19	TD-	Transmitter Inverted Data In. AC Coupled. CML-O.	
20	VeeT	Transmitter Ground (Common with Receiver Ground).	1

Notes:

1. The module signal ground contacts, VeeR and VeeT, should be isolated from the module case.
2. This contact is an open collector/drain output and should be pulled up to the Host_Vcc with resistor in the range 4.7kΩ to 10kΩ. Pull-ups can be connected to one or several power supplies; however, the host board design shall ensure that no module contact has a voltage exceeding the module VccT/R+0.5V.
3. Tx_Disable is an input contact with a 4.7kΩ to 10kΩ pull-up resistor to the VccT inside the module.
4. MOD_ABS is connected to the VeeT or VeeR in the SFP+ module. The host may pull the contact up to the Host_Vcc with a resistor in the range from 4.7kΩ to 10kΩ. MOD_ABS is asserted “high” when the SFP+ module is physically absent from a host slot.
5. Internally pulled down per SFF-8431.



Pin-Out of Connector Block on the Host Board

Recommended Circuit Schematic



Mechanical Specifications

Small Form Factor Pluggable (SFP) transceivers are compatible with the dimensions defined by the SFP Multi-Sourcing Agreement (MSA).

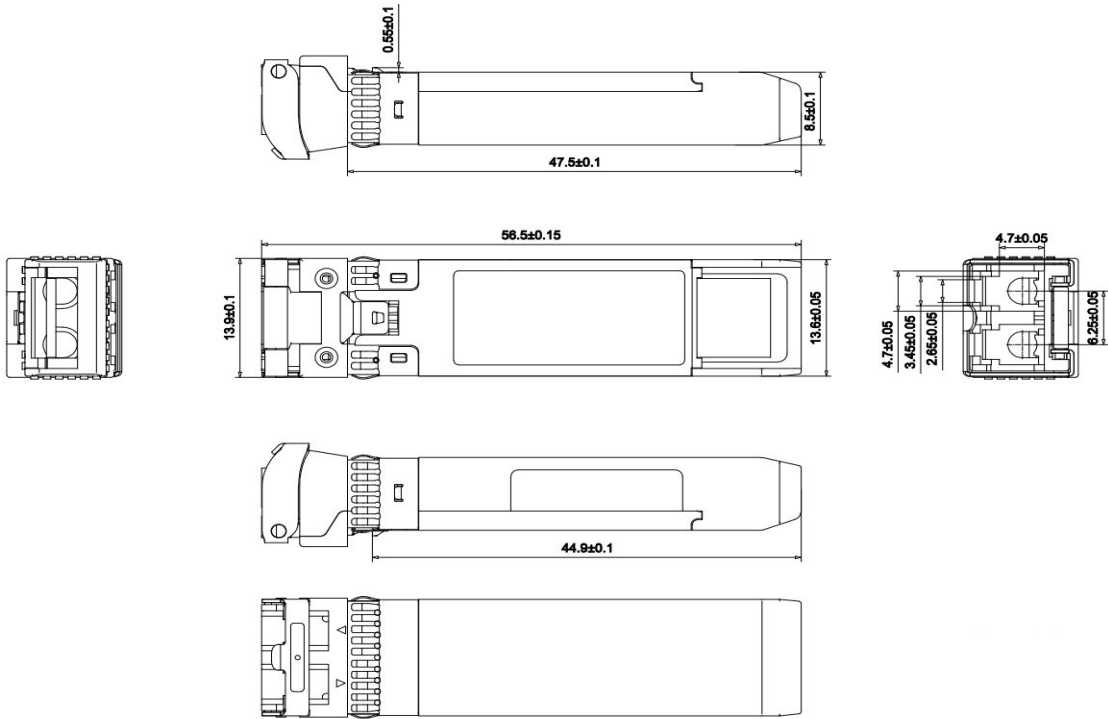

OptioConnect

Innovation for the Future of High-Speed Networking

Who We Are

OptioConnect is reshaping the landscape of communication and high-speed networking through intelligent technology. With a core focus on cutting edge technology, we deliver smarter fiber optic solutions for enterprise networks, data centers, and next-gen telecom infrastructures.

What We Do

At OptioConnect, we fuse advanced engineering with intelligent automation to drive the future of networking. Our AI-integrated solutions are designed to optimize performance and streamline operations with:

- Superior Performance
- Network and traffic optimization
- Intelligent energy management
- Seamless OEM compatibility
- Scalable cost-efficiency

Smarter Networks by Design

Innovation isn't just a goal—it's our process. We embed AI and machine learning across our R&D and product lines, enabling adaptive performance, automated tuning, and faster deployment cycles. The result? Networks that don't just work—they learn, evolve, and outperform.

Our Team

Our engineers, data scientists, and network architects bring decades of experience and a future-focused mindset. We provide hands-on support with intelligent insights that turn complex challenges into simple solutions.

Our Mission

To deliver AI-enhanced connectivity that reduces cost, increases speed, and maximizes efficiency—empowering our partners to operate at the forefront of a rapidly evolving digital world.

Let's Connect

Discover how OptioConnect's intelligent infrastructure solutions can power your network's next leap forward.

www.optioconnect.com | info@optioconnect.com

