

DWDM-SFP-4373-40-OPC

Cisco® DWDM-SFP-4373-40 Compatible TAA 1000Base-DWDM SFP Transceiver C-Band 100GHz (SMF, 1543.73nm, 40km, LC, DOM)

Features

- INF-8074 and SFF-8472 Compliance
- Duplex LC Connector
- Single-mode Fiber
- Commercial Temperature 0 to 70 Celsius
- Hot Pluggable
- Metal with Lower EMI
- Excellent ESD Protection
- RoHS Compliant and Lead Free



Applications:

- Gigabit Ethernet over DWDM
- 1x Fibre Channel
- Access, Metro and Enterprise

Product Description

This Cisco® DWDM-SFP-4373-40 compatible SFP transceiver provides 1000Base-DWDM throughput up to 40km over single-mode fiber (SMF) using a wavelength of 1543.73nm via an LC connector. It is guaranteed to be 100% compatible with the equivalent Cisco® transceiver. This easy to install, hot swappable transceiver has been programmed, uniquely serialized and data-traffic and application tested to ensure that it will initialize and perform identically. Digital optical monitoring (DOM) support is also present to allow access to real-time operating parameters. This transceiver is Trade Agreements Act (TAA) compliant. We stand behind the quality of our products and proudly offer a limited lifetime warranty.

OptioConnect's transceivers are RoHS compliant and lead-free.

TAA refers to the Trade Agreements Act (19 U.S.C. & 2501-2581), which is intended to foster fair and open international trade. TAA requires that the U.S. Government may acquire only "U.S.-made or designated country end products."



Regulatory Compliance

- ESD to the Electrical PINs: compatible with MIL-STD-883E Method 3015.4
- ESD to the LC Receptacle: compatible with IEC 61000-4-3
- EMI/EMC compatible with FCC Part 15 Subpart B Rules, EN55022:2010
- Laser Eye Safety compatible with FDA 21CFR, EN60950-1& EN (IEC) 60825-1,2
- RoHS compliant with EU RoHS 2.0 directive 2015/863/EU

Wavelength Guide (100GHz ITU-T Channel)

ITU Channel #	Frequency (THZ)	Center Wavelength (nm)
61	196.1	1528.77
60	196.0	1529.55
59	195.9	1530.33
58	195.8	1531.12
57	195.7	1531.90
56	195.6	1532.68
55	195.5	1533.47
54	195.4	1534.25
53	195.3	1535.04
52	195.2	1535.82
51	195.1	1536.61
50	195.0	1537.40
49	194.9	1538.19
48	194.8	1538.98
47	194.7	1539.77
46	194.6	1540.56
45	194.5	1541.35
44	194.4	1542.14
43	194.3	1542.94
42	194.2	1543.73
41	194.1	1544.53
40	194.0	1545.32
39	193.9	1546.12
38	193.8	1546.92
37	193.7	1547.72
36	193.6	1548.51
35	193.5	1549.32
34	193.4	1550.12
33	193.3	1550.92
32	193.2	1551.72
31	193.1	1552.52
30	193.0	1553.33
29	192.9	1554.13
28	192.8	1554.94
27	192.7	1555.75
26	192.6	1556.55

25	192.5	1557.36
24	192.4	1558.17
23	192.3	1558.98
22	192.2	1559.79
21	192.1	1560.61
20	192.0	1561.42
19	191.9	1562.23
18	191.8	1563.05
17	191.7	1563.86

Absolute Maximum Ratings

Parameter	Symbol	Min.	Max.	Unit
Maximum Supply Voltage	V _{CC}	-0.5	4.0	V
Storage Temperature	T _S	-40	85	°C
Operating Case Temperature	T _c	0	70	°C
Operating Humidity	RH	5	85	%

Electrical Characteristics (TOP=25°C, V_{CC}=3.3Volts)

Parameter	Symbol	Min.	Typ.	Max.	Unit	Notes
Power Supply Voltage	V _{CC}	3.14	3.30	3.46	V	
Power Supply Current	I _{CC}			450	mA	
Supply Voltage	V _{MAX}	-0.5		4	V	
Transmitter						
Differential data input voltage (TD +/-)		200		1200	mVp-p	1
Low speed output: Tx Fault/ Loss of Signal (LOS)	VOH	2.0		V _{CC}	V	2
	VOL	0		0.8	V	
Low speed output: Tx Disable / MOD_DEF1, MOD_DEF 2	VOH	2.0		V _{CC}	V	3
	VOL	0		0.8	V	
Receiver						
Differential data output voltage		600		1200	mVp-p	4

Notes

1. Internally AC coupled and terminated to 100Ω differential load.
2. Pulled up externally with a 4.7KΩ-10KΩ resistor on the host board to VCCT,R.
3. Mod_Def1 and Mod_Def2 must be pulled up externally with a 4.7KΩ-10KΩ resistor on the host board to VCCT,R.

- Internally AC coupled, but requires a 100Ω differential termination or internal to Serializer/Deserializer.

Optical Characteristics

Parameter	Symbol	Min.	Typ.	Max.	Unit	Notes
Transmitter						
Wavelength Spacing			100		GHz	
Optical Wavelength	T_{λ}	x-0.1	x	X+0.1	nm	
Optical Power (average)	P_{AVE}	0		4	dBm	1
Transmitter and Dispersion Penalty	TDP			3	dB	
Optical Extinction Ratio	ER	8.0			dB	
Spectral Width	$\Delta\lambda$			0.3	nm	
Sidemode Suppression Ratio	SMSR	30			dB	
Optical Rise/Fall Time (20%-80%)	t_r/t_f			260	ps	
Eye Diagram		Compatible with IEEE 802.3				
Receiver						
Receiver Wavelength	λ_C	1528		1566	nm	
Receiver Sensitivity (average)	R_{AVE}			-20	dBm	2
Receiver overload	P_{max}	-1			dBm	3
LOS Assert	LOS_A	-35			dBm	
LOS De-Assert	LOS_D			-22	dBm	
LOS Hysteresis	LOS_H	0.5			dBm	

Notes:

- Coupled into a Single-mode fibre
- Average power, back-to-back, @1.25Gbps, BER $1E^{-12}$, PRBS $2^{31}-1$.
- Exceeding the Receiver overload can physically damage the module. Please use appropriate attenuation.

Pin Descriptions

Pin	Symbol	Name/Descriptions	Ref.
1	VeeT	Transmitter Ground (Common with Receiver Ground).	1
2	TX Fault	Transmitter Fault. LVTTTL-O	2
3	TX Disable	Transmitter Disable. Laser output disabled on high or open. LVTTT-I.	3
4	SDA	2-Wire Serial Interface Data Line (Same as MOD-DEF2 in INF-8074i). LVTTTL-I/O.	
5	SCL	2-Wire Serial Interface Data Line (Same as MOD-DEF2 in INF-8074i). LVTTTL-I.	
6	MOD_ABS	Module Absent, Connect to VeeT or VeeR in Module.	4
7	RS0	Rate Select 0. Not used	5
8	LOS	Loss of Signal indication. Logic 0 indicates normal operation. LVTTTL-O.	2
9	RS1	Rate Select 1. Not used	5
10	VeeR	Receiver Ground (Common with Transmitter Ground).	1
11	VeeR	Receiver Ground (Common with Transmitter Ground).	1
12	RD-	Receiver Inverted DATA out. AC Coupled. CML-O.	
13	RD+	Receiver Non-inverted DATA out. AC Coupled. CML-O.	
14	VeeR	Receiver Ground (Common with Transmitter Ground).	1
15	VccR	Receiver Power Supply.	
16	VccT	Transmitter Power Supply.	
17	VeeT	Transmitter Ground (Common with Receiver Ground).	1
18	TD+	Transmitter Non-Inverted DATA in. AC Coupled. CML-I.	
19	TD-	Transmitter Inverted DATA in. AC Coupled. CML-O.	
20	VeeT	Transmitter Ground (Common with Receiver Ground).	1

Notes:

1. The module signal ground contacts, VeeR and VeeT, should be isolated from the module case.
2. This contact is an open collector/drain output and should be pulled up to the Vcc_Host with resistor in the range 4.7KΩ to 10KΩ. Pull ups can be connected to one or several power supplies, however the host board design shall ensure that no module contract has voltage exceeding module VccT/R +0.5.V.
3. Tx_Disable is an input contact with a 4.7KΩ to 10KΩ pull-up resistor to VccT inside module.
4. Mod_ABS is connected to VeeT or VeeR in the SFP+ module. The host may pull the contract up to Vcc_Host with a resistor in the range from 4.7KΩ to 10KΩ. Mod_ABS is asserted "High" when the SFP+ module is physically absent from a host slot.
5. Internally pulled down per SFF-8431

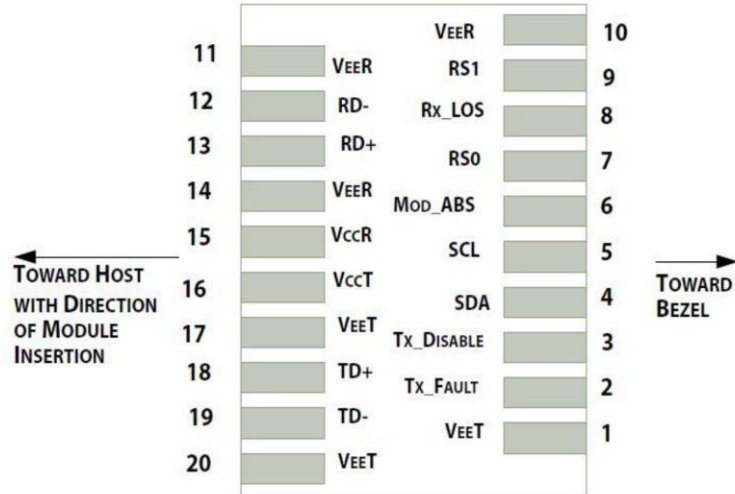

Pin-out of connector Block on Host board

Recommended Circuit Schematic

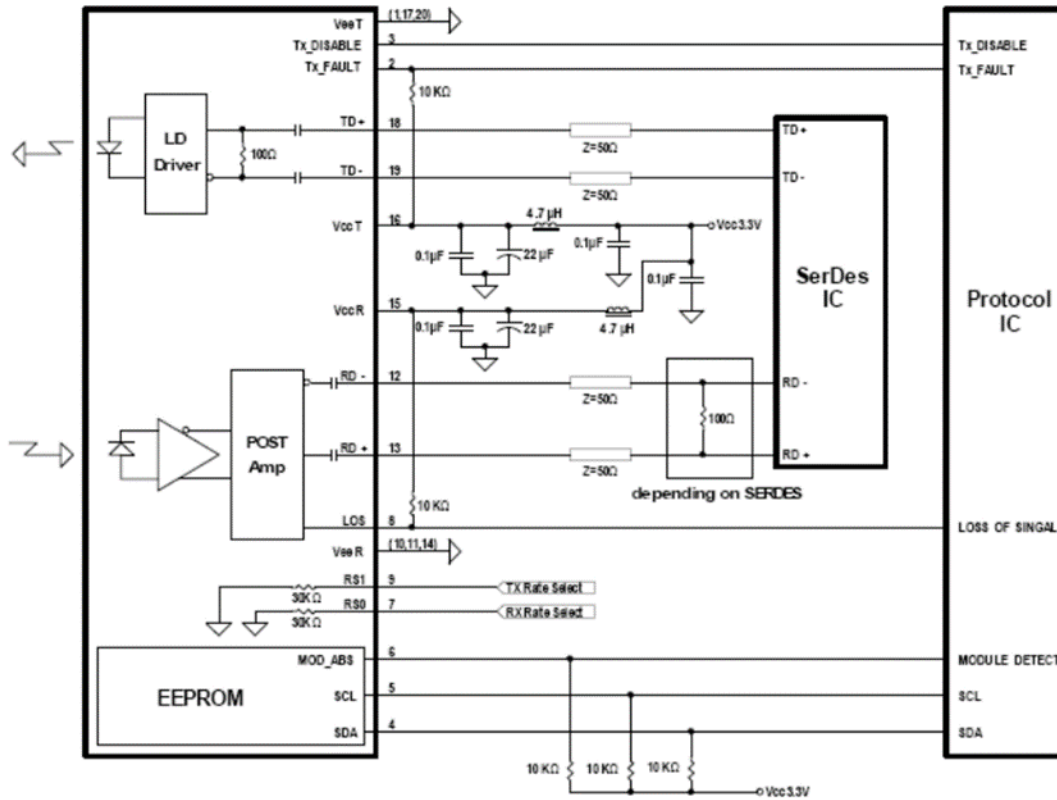

Mechanical Specifications

Small Form Factor Pluggable (SFP) transceivers are compatible with the dimensions defined by the SFP Multi-Sourcing Agreement (MSA).



EEPROM Information

EEPROM memory map specific data field description is as below:



OptioConnect

Innovation for the Future of High-Speed Networking

Who We Are

OptioConnect is reshaping the landscape of communication and high-speed networking through intelligent technology. With a core focus on cutting edge technology, we deliver smarter fiber optic solutions for enterprise networks, data centers, and next-gen telecom infrastructures.

What We Do

At OptioConnect, we fuse advanced engineering with intelligent automation to drive the future of networking. Our AI-integrated solutions are designed to optimize performance and streamline operations with:

- Superior Performance
- Network and traffic optimization
- Intelligent energy management
- Seamless OEM compatibility
- Scalable cost-efficiency

Smarter Networks by Design

Innovation isn't just a goal—it's our process. We embed AI and machine learning across our R&D and product lines, enabling adaptive performance, automated tuning, and faster deployment cycles. The result? Networks that don't just work—they learn, evolve, and outperform.

Our Team

Our engineers, data scientists, and network architects bring decades of experience and a future-focused mindset. We provide hands-on support with intelligent insights that turn complex challenges into simple solutions.

Our Mission

To deliver AI-enhanced connectivity that reduces cost, increases speed, and maximizes efficiency—empowering our partners to operate at the forefront of a rapidly evolving digital world.

Let's Connect

Discover how OptioConnect's intelligent infrastructure solutions can power your network's next leap forward.

www.optioconnect.com | info@optioconnect.com

