

QSFP-SFP25G-CU-3M-AO

Cisco® QSFP-SFP25G-CU-3M Compatible TAA Compliant 25GBase-CU QSFP28 to 1xSFP28 Direct Attach Cable (Passive Twinax, 3m)

Features

- QSFP28 End: Compliant with QSFP28 MSA Specifications
- Duplex Operating at 25Gbps
- SFP28 End: Compliant with SFP28 MSA Specifications
- Low Power Consumption
- Metal Housing for Superior EMI Performance
- AC Coupled Inputs and Outputs
- Operating Temperature: 0 to 70 Celsius
- Single Power Supply: 3.3V
- RoHS Compliant and Lead-Free



Applications

- Infiniband EDR
- Serial Data Transmission
- Fibre Channel

Product Description

This is a Cisco® QSFP-SFP25G-CU-3M 25GBase-CU QSFP28 to 1xSFP28 direct attach cable that operates over passive copper with a maximum reach of 3.0m (9.8ft). It has been programmed, uniquely serialized, and data-traffic and application tested to ensure it is 100% compliant and functional. This direct attach cable is TAA (Trade Agreements Act) compliant, and is built to comply with MSA (Multi-Source Agreement) standards. We stand behind the quality of our products and proudly offer a limited lifetime warranty.

AddOn's transceivers are RoHS compliant and lead-free.

TAA refers to the Trade Agreements Act (19 U.S.C. & 2501-2581), which is intended to foster fair and open international trade. TAA requires that the U.S. Government may acquire only "U.S.-made or designated country end products."



General Specifications

Parameter	Symbol	Min.	Typ.	Max.	Unit	Notes
Bit Error Rate	BER			10 ⁻¹²		
Operating Temperature	Tc	0		70	°C	1
Storage Temperature	Tstg	-40		85	°C	2
Input Voltage	Vcc	3.14	3.3	3.46	V	
Product Weight	GD28		105		g/PCS	3
Cable Weight	GC28		38		g/M	4
SFP28 End Dust Cap Weight	Gs		0.80		g/PCS	
QSFP28 End Dust Cap Weight	Gq		1.40		g/PCS	

Notes:

1. Case temperature.
2. Ambient temperature.
3. The weight of the product.
4. The weight of unit length cable (two sticks). For example, the weight of a 26AWG cable is 110+43*(5-1)+0.80+1.40=284.2g.

Insertion Loss Level and Wire Gauge

Cable Length	Wire Gauge	Insertion Loss Level
3M	28AWG	CA-25G-S

Notes:

1. Cable insertion loss classification standard is IEEE 802.3by 110-10.

Cable Specifications

Parameter	Symbol	Min.	Typ.	Max.	Unit	Notes
Wire Gauge		30		26	AWG	
Cable Impedance	Z	90	100	110	Ω	

Cable Dimension and Nominal Length

Standard Wire Gauge (AWG)	Cable Diameter OD (mm)	Minimum Bending Radius R (mm)	Module Nominal Length L1 (cm)	Tolerance Range ± (cm)
28	5.0	28	3 < L1 ≤ 4	4

Pin Descriptions (QSFP28 End)

Pin	Symbol	Name/Description	Notes
1	GND	Module Ground.	1
2	Tx2-	Transmitter Inverted Data Input. LAN2.	
3	Tx2+	Transmitter Non-Inverted Data Input. LAN2.	
4	GND	Module Ground.	1
5	Tx4-	Transmitter Inverted Data Input. LAN4.	
6	Tx4+	Transmitter Non-Inverted Data Input. LAN4.	
7	GND	Module Ground.	1
8	ModSelL	Module Select Pin. The module responds to 2-wire serial communication when low level.	2
9	ResetL	Module Reset.	3
10	VccRx	+3.3V Receiver Power Supply.	
11	SCL	2-Wire Serial Interface Clock.	
12	SDA	2-Wire Serial Interface Data.	
13	GND	Module Ground.	1
14	Rx3+	Receiver Non-Inverted Data Output. LAN3.	
15	Rx3-	Receiver Inverted Data Output. LAN3.	
16	GND	Module Ground.	1
17	Rx1+	Receiver Non-Inverted Data Output. LAN1.	
18	Rx1-	Receiver Inverted Data Output. LAN1.	
19	GND	Module Ground.	1
20	GND	Module Ground.	1
21	Rx2-	Receiver Inverted Data Output. LAN2.	
22	Rx2+	Receiver Non-Inverted Data Output. LAN2.	
23	GND	Module Ground.	1
24	Rx4-	Receiver Inverted Data Output. LAN4.	
25	Rx4+	Receiver Non-Inverted Data Output. LAN4.	
26	GND	Module Ground.	1
27	ModPrsL	The module is inserted into the indicate pin and grounded in the module.	4
28	IntL	Interrupt.	5
29	VccTx	+3.3V Transmitter Power Supply.	
30	Vcc1	+3.3V Power Supply.	
31	LPMoDe	Low-Power Mode.	1
32	GND	Module Ground.	1
33	Tx3+	Transmitter Non-Inverted Data Input. LAN3.	
34	Tx3-	Transmitter Inverted Data Input. LAN3.	

35	GND	Module Ground.	1
36	Tx1+	Transmitter Non-Inverted Data Input. LAN1.	
37	Tx1-	Transmitter Inverted Data Input. LAN1.	
38	GND	Module Ground.	1

Notes:

1. The circuit ground is internally isolated from the chassis ground.
2. ModSelL is the input pin. The module responds to 2-wire serial communication commands when it is held “low” by the host. ModSelL allows multiple QSFP modules to be used on a single 2-wire interface bus. If ModSelL is “high,” the module will not respond to any 2-wire interface communication from the host. ModSelL has internal pull-up resistors in the module.
3. The module restart pin, when the low level on the ResetL pin lasts longer than the minimum pulse length, resets the module and restores all user modules to their default state. When performing reset device, the host should ignore all status bits. Until the module reset interrupt is completed, please note that, during hot-plugging, the module will issue this information to complete the reset interrupt without resetting.
4. This pin is active “high,” indicating that the module is running under a low-power module. The signal has no effect on the functionality of this product.
5. IntL is the output pin, which is the open collector output and must be pulled up to Vcc with a 4.7kΩ to 10kΩ resistor on the motherboard. When it is “low,” it indicates that the module may malfunction. The host uses a 2-wire serial interface to identify the interrupt source.

Electrical Pin-Out Details (QSFP28 End)



Pin Descriptions (SFP28 End)

Pin	Symbol	Name/Description	Notes
1	Veet	Transmitter Ground (Common with Receiver Ground).	1
2	Tx_Fault	Transmitter Failure Alarm. Not used.	
3	Tx_Disable	The signal turns off the module transmitter when it is "high" or "open." Not used.	
4	SDA	Data Line for Serial ID.	2
5	SCL	Clock Line for Serial ID.	2
6	MOD_ABS	Module Absent. Grounded within the module.	2
7	RS0	No Connection Required.	
8	LOS	Loss of Signal Indication. "Logic 0" indicates normal operation.	
9	RS1	No Connection Required.	
10	VeeR	Receiver Ground (Common with Transmitter Ground).	1
11	VeeR	Receiver Ground (Common with Transmitter Ground).	1
12	RD-	Receiver Inverted Data Out. AC Coupled.	
13	RD+	Receiver Non-Inverted Data Out. AC Coupled.	
14	VeeR	Receiver Ground (Common with Transmitter Ground).	1
15	VccR	Receiver Power Supply.	
16	VccT	Transmitter Power Supply.	
17	VeeT	Transmitter Ground (Common with Receiver Ground).	1
18	TD+	Transmitter Non-Inverted Data In. AC Coupled.	
19	TD-	Transmitter Inverted Data In. AC Coupled.	
20	VeeT	Transmitter Ground (Common with Receiver Ground).	1

Notes:

1. The circuit ground should be isolated from the chassis ground.
2. Should be pulled up with 4.7k Ω to 10k Ω on the host board to a voltage between 2V and 3.6V.

Electrical Pin-Out Details (SFP28 End)



Mechanical Specifications

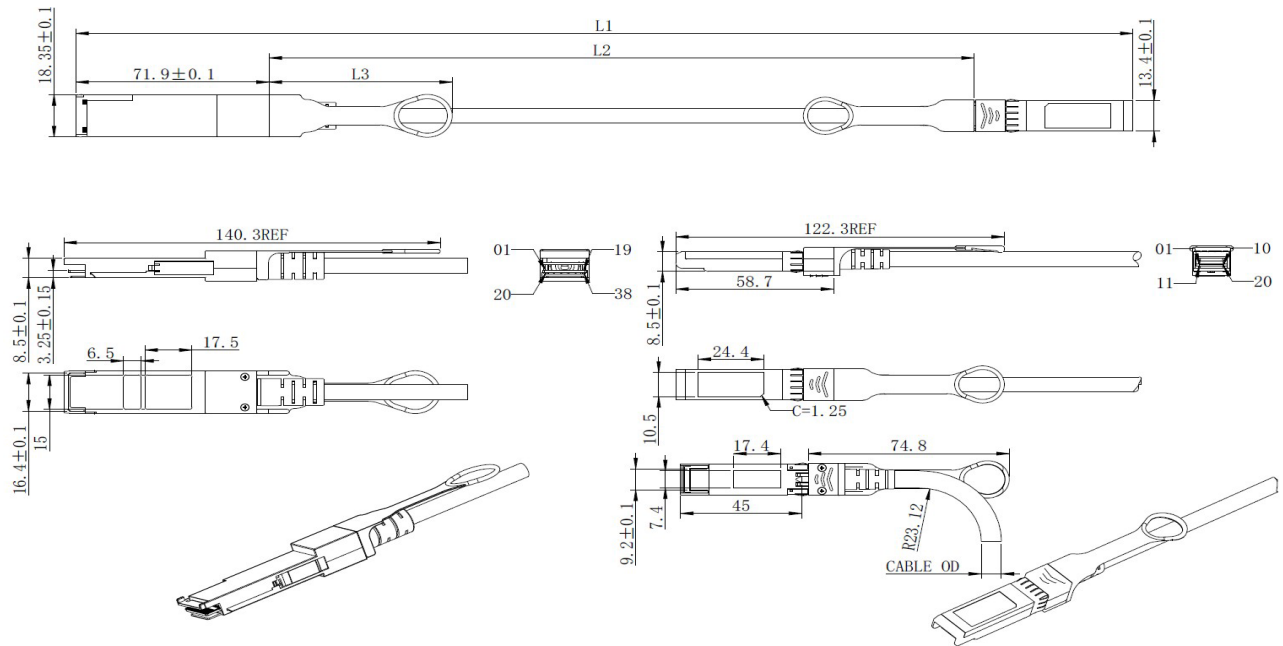

All dimensions are $\pm 0.2 \text{ mm}$ unless otherwise specified. Unit: mm.

About AddOn Networks

In 1999, AddOn Networks entered the market with a single product. Our founders fulfilled a severe shortage for compatible, cost-effective optical transceivers that compete at the same performance levels as leading OEM manufacturers. Adhering to the idea of redefining service and product quality not previously had in the fiber optic networking industry, AddOn invested resources in solution design, production, fulfillment, and global support.

Combining one of the most extensive and stringent testing processes in the industry, an exceptional free tech support center, and a consistent roll-out of innovative technologies, AddOn has continually set industry standards of quality and reliability throughout its history.

Reliability is the cornerstone of any optical fiber network and is ingrained in AddOn's DNA. It has played a key role in nurturing the long-term relationships developed over the years with customers. AddOn remains committed to exceeding industry standards with certifications ranging from NEBS Level 3 to ISO 9001:2015 with every new development while maintaining the signature reliability of its products.



U.S. Headquarters

Email: sales@addonnetworks.com

Telephone: +1 877.292.1701

Fax: 949.266.9273

Europe Headquarters

Email: salesemea@addonnetworks.com

Telephone: +44 1285 842070