

QDD4-400GB-DR4-CN2-C

Ciena® Compatible TAA 400GBase-DR4 QSFP-DD Transceiver (SMF, 1310nm, 500m, MPO, DOM, CMIS 4.0)

Features:

- Compliant with IEEE802.3bs Standard: 400GAUI-8 Electrical Interface
- Compliant with IEEE 802.3bs Standard: 400GBASE-DR4 Optical Interface
- QSFP-DD MSA Compliant
- MPO-12 Connector
- CMIS 4.0
- Class 1 Laser
- Operating Temperature: 0 to 70 Celsius
- RoHS Compliant and Lead-Free
- RoHS compliant and Lead Free



Applications:

- 400GBase Ethernet

Product Description

This Ciena® compatible QSFP-DD transceiver provides 400GBase-DR4 throughput up to 500m over single-mode fiber (SMF) using a wavelength of 1310nm via an MPO connector. Our transceiver is built to meet or exceed OEM specifications and is guaranteed to be 100% compatible with Ciena®. It has been programmed, uniquely serialized, and tested for data-traffic and application to ensure that it will initialize and perform identically. All of our transceivers comply with Multi-Source Agreement (MSA) standards to provide seamless network integration. Additional product features include Digital Optical Monitoring (DOM) support which allows access to real-time operating parameters. This transceiver is Trade Agreements Act (TAA) compliant. We stand behind the quality of our products and proudly offer a limited lifetime warranty.

ProLabs' transceivers are RoHS compliant and lead-free.

TAA refers to the Trade Agreements Act (19 U.S.C. & 2501-2581), which is intended to foster fair and open international trade. TAA requires that the U.S. Government may acquire only "U.S.-made or designated country end products."



Absolute Maximum Ratings

Parameter	Symbol	Min.	Typ.	Max.	Unit	Notes
Storage Temperature	Tstg	-40		85	°C	
Operating Case Temperature	Tc	0	25	70	°C	
Supply Voltage	Vcc	-0.5		3.6	V	
Relative Humidity	RH	5		95	%	
Operating Distance		2		500	m	
Signaling Speed Per Lane	DRL		53.125		GBd	PAM4
Maximum Power Dissipation	PD			9	W	
Maximum Power Dissipation (Low-Power Mode)	PDLP			2	W	
Rx Differential Data Output Load			100		Ω	

Electrical Characteristics

Parameter	Symbol	Min.	Typ.	Max.	Unit	Notes
Power Supply Voltage	Vcc	3.135	3.3	3.465	V	
Control Input Voltage	VI	-0.3		Vcc+0.5	V	
Instantaneous Peak Current at Hot Plug	Icc_IP			3600	mA	
Sustained Peak Current at Hot Plug	Icc_SP			2970	mA	
2-Wire Serial Interface Clock Rate				400	kHz	
Power Supply Noise (10Hz-10MHz)				66	mVp-p	
Transmitter - Module Input						
Differential Pk-Pk Input Voltage Tolerance		900			mV	
Differential Termination Mismatch				10	%	
Single-Ended Voltage Tolerance Range		-0.4		3.3	V	
DC Common-Mode Voltage		-350		2850	mV	
Receiver - Module Output						
AC Common-Mode Output Voltage (RMS)				17.5	mV	
Differential Output Voltage				900	mV	
Differential Near-End Eye Height		70			mV	
Differential Far-End Eye Height		30			mV	
Far-End Pre-Cursor Ratio		-4.5		2.5	%	
Differential Termination Mismatch				10	%	
Transition Time (Minimum, 20-80%)		9.5			ps	
DC Common-Mode Voltage		-350		2850	mV	
Low-Speed Control and Sense Signals						
Module Output SCL and SDA	VOL	0		0.4	V	
Module Input SCL and SDA	VIL	-0.3		Vcc*0.3	V	
	VIH	Vcc*0.7		Vcc+0.5	V	
InitMode, ResetL, and ModSelL	VIL	-0.3		0.8	V	
	VIH	2		Vcc+0.3	V	
IntL	VOL	0		0.4	V	
	VOH	Vcc-0.5		Vcc+0.3	V	

Optical Characteristics

Parameter	Symbol	Min.	Typ.	Max.	Unit	Notes
Transmitter						
Center Wavelength	λ_C	1304.5	1311	1317.5	nm	
Side-Mode Suppression Ratio	SMSR	30			dB	
Average Launch Power Per Lane	P	-2.9		4.0	dBm	1
Outer Optical Modulation Amplitude (OMA _{outer}) Per Lane	TOMA	-0.8		4.2	dBm	2
Launch Power in OMA _{outer} Minus TDECQ Per Lane	TOMA	-2.2			dBm	
Transmitter and Dispersion Eye Closure for PAM4 (TDECQ) Per Lane	TDECQ			3.4	dB	
TDECQ-TECQ 10log10 (C _{eq})				3.4	dB	
Average Launch Power of Off Transmitter Per Lane	T _{off}			-15	dBm	
Extinction Ratio Per Lane	ER	3.5			dB	
Transmitter Transition Time				17	ps	
RIN _{21.4OMA}	RIN			-136	dB/Hz	
Optical Return Loss Tolerance	ORLT			21.4	dB	
Transmitter Reflectance	TR			-26	dB	3
Receiver						
Center Wavelength	λ_C	1304.5	1311	1317.5	nm	
Damage Threshold Per Lane		5			dBm	
Average Receiver Power Per Lane	P _{avg}	-5.9		4.0	dBm	1
Receive Power Per Lane (OMA _{outer})				4.2	dBm	
Receiver Reflectance	RR			-26	dB	
Receiver Sensitivity Per Lane (OMA _{outer})	SOMA			-4.4	dBm	2
Stressed Receiver Sensitivity Per Lane (OMA _{outer})	SRS			-1.9	dBm	3
Conditions of Stressed Receiver Sensitivity Test						
Stressed Eye Closure for PAM4 (SECQ) Per Lane Under Test			3.4		dB	
SECQ -10log10 (C _{eq}) Per Lane Under Test				3.4	dB	
OMA _{outer} of Each Aggressor Lane			4.2		dBm	

Notes:

1. Average launch power, per lane (minimum), is informative and not the principal indicator of signal strength.
2. Even if TDECQ < 1.4dB, OMA_{outer} (minimum) must exceed this value.
3. Transmitter reflectance is defined looking into the transmitter.
4. Average receive power, per lane (minimum), is informative and not the principal indicator of signal strength.
5. Receiver sensitivity (OMA_{outer}), per lane (maximum), is informative and is defined for a transmitter with a value of SECQ up to 3.4dB.

6. Measured with conformance test signals at TP3 for the BER=2.4x10⁻⁴.

Pin Descriptions

Pin	Logic	Symbol	Name/Description	Notes
1		GND	Module Ground.	
2	CML-I	Tx2-	Transmitter Inverted Data Input.	
3	CML-I	Tx2+	Transmitter Non-Inverted Data Input.	
4		GND	Module Ground.	
5	CML-I	Tx4-	Transmitter Inverted Data Input.	
6	CML-I	Tx4+	Transmitter Non-Inverted Data Input.	
7		GND	Module Ground.	
8	LVTTTL-I	ModSelL	Module Select.	
9	LVTTTL-I	ResetL	Module Reset.	
10		VccRx	+3.3V Receiver Power Supply.	
11	LVC MOS-I/O	SCL	2-Wire Serial Interface Clock.	
12	LVC MOS-I/O	SDA	2-Wire Serial Interface Data.	
13		GND	Module Ground.	
14	CML-O	Rx3+	Receiver Non-Inverted Data Output.	
15	CML-O	Rx3-	Receiver Inverted Data Output.	
16		GND	Module Ground.	
17	CML-O	Rx1+	Receiver Non-Inverted Data Output.	
18	CML-O	Rx1-	Receiver Inverted Data Output.	
19		GND	Module Ground.	
20		GND	Module Ground.	
21	CML-O	Rx2-	Receiver Inverted Data Output.	
22	CML-O	Rx2+	Receiver Non-Inverted Data Output.	
23		GND	Module Ground.	
24	CML-O	Rx4-	Receiver Inverted Data Output.	
25	CML-O	Rx4+	Receiver Non-Inverted Data Output.	
26		GND	Module Ground.	
27	LVTTTL-O	ModPrsL	Module Present.	
28	LVTTTL-O	IntL	Interrupt	
29		VccTx	+3.3V Transmitter Power Supply.	
30		Vcc1	+3.3V Power Supply.	
31	LVTTTL-I	InitMode	Initialization Mode.	
32		GND	Module Ground.	
33	CML-I	Tx3+	Transmitter Non-Inverted Data Input.	
34	CML-I	Tx3-	Transmitter Inverted Data Input.	
35		GND	Module Ground.	
36	CML-I	Tx1+	Transmitter Non-Inverted Data Input.	
37	CML-I	Tx1-	Transmitter Inverted Data Output.	
38		GND	Module Ground.	

39		GND	Module Ground.	
40	CML-I	Tx6-	Transmitter Inverted Data Input.	
41	CML-I	Tx6+	Transmitter Non-Inverted Data Input.	
42		GND	Module Ground.	
43	CML-I	Tx8-	Transmitter Inverted Data Input.	
44	CML-I	Tx8+	Transmitter Non-Inverted Data Input.	
45		GND	Module Ground.	
46		Reserved		
47		VS1	Module Vendor-Specific 1.	
48		VccRx1	+3.3V Receiver Power Supply.	
49		VS2	Module Vendor-Specific 2.	
50		VS3	Module Vendor-Specific 3.	
51		GND	Module Ground.	
52	CML-O	Rx7+	Receiver Non-Inverted Data Output.	
53	CML-O	Rx7-	Receiver Inverted Data Output.	
54		GND	Module Ground.	
55	CML-O	Rx5+	Receiver Non-Inverted Data Output.	
56	CML-O	Rx5-	Receiver Inverted Data Output.	
57		GND	Module Ground.	
58		GND	Module Ground.	
59	CML-O	Rx6-	Receiver Inverted Data Output.	
60	CML-O	Rx6+	Receiver Non-Inverted Data Output.	
61		GND	Module Ground.	
62	CML-O	Rx8-	Receiver Inverted Data Output.	
63	CML-O	Rx8+	Receiver Non-Inverted Data Output.	
64		GND	Module Ground.	
65		NC	Not Connected.	
66		Reserved		
67		VccTx1	+3.3V Transmitter Power Supply.	
68		Vcc2	+3.3V Power Supply.	
69		Reserved		
70		GND	Module Ground.	
71	CML-I	Tx7+	Transmitter Non-Inverted Data Input.	
72	CML-I	Tx7-	Transmitter Inverted Data Input.	
73		GND	Module Ground.	
74	CML-I	Tx5+	Transmitter Non-Inverted Data Input.	
75	CML-I	Tx5-	Transmitter Inverted Data Input.	
76		GND	Module Ground.	

Electrical Pin-Out Details

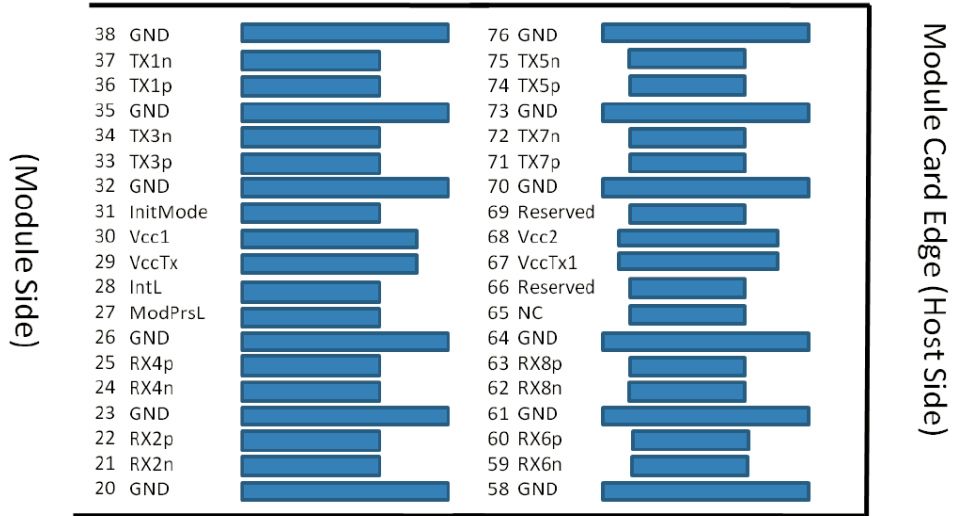

Top side viewed from top

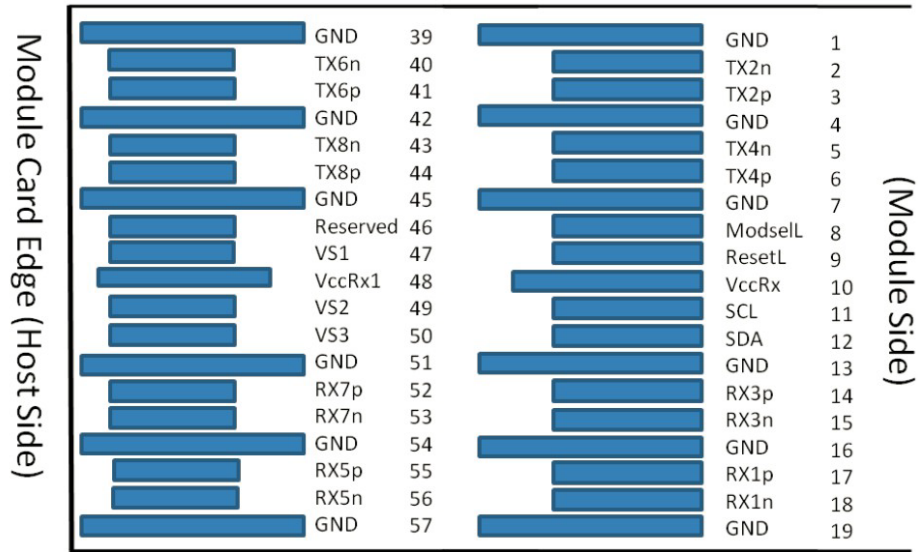

Bottom side viewed from bottom

Active Fiber Ports in MPO-12 Connector on Module Side

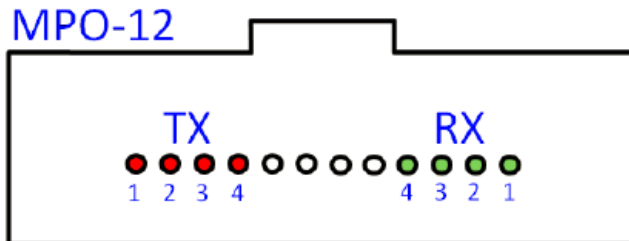

Host Board Schematic

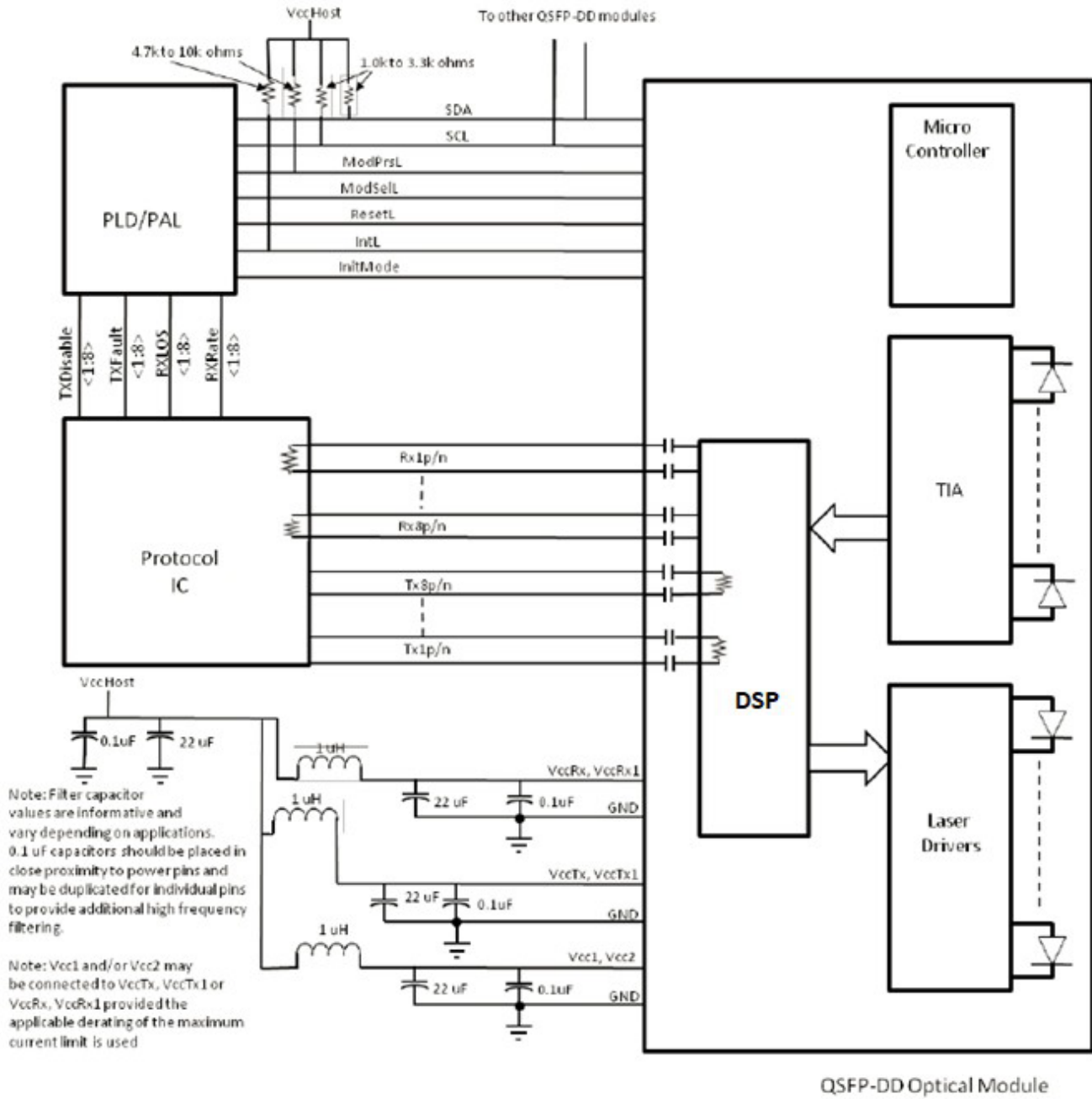

Mechanical Specifications

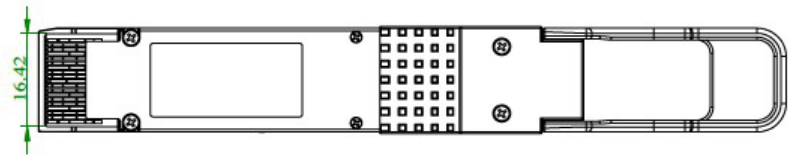
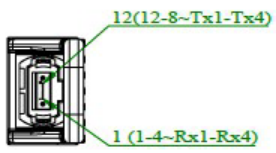
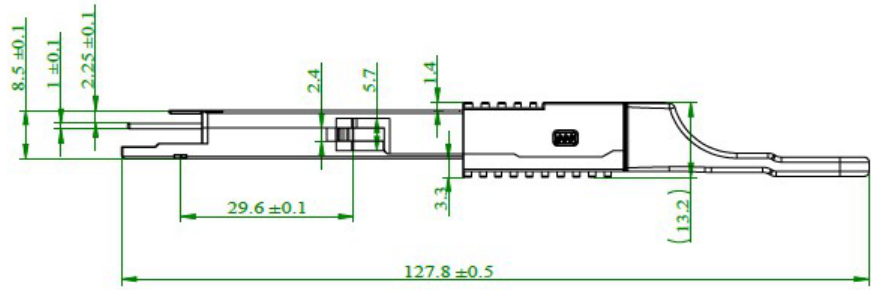
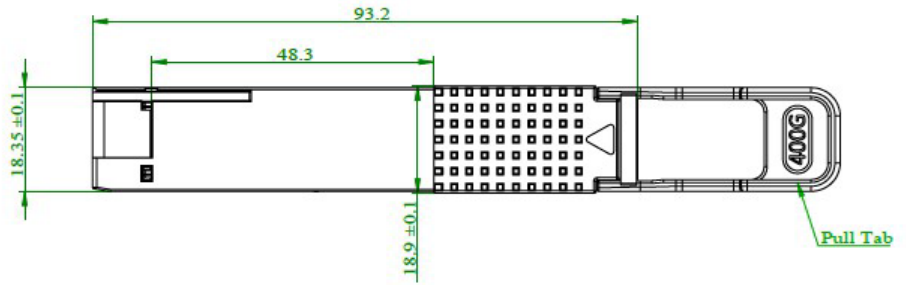

About ProLabs

Our extensive experience comes as standard. For over 20 years ProLabs has delivered optical connectivity solutions that give our customers freedom and choice through our ability to provide seamless interoperability. At the heart of our company is the ability to provide state-of-the-art optical transport and connectivity solutions that are compatible with more than 100 optical switching and transport platforms.

A Complete Portfolio of Network Solutions

ProLabs is focused on innovations in optical transport and connectivity. The combination of our knowledge of optics and networking equipment enables ProLabs to be your single source for optical transport and connectivity solutions from 100Mb to 1.6T while providing innovative solutions that increase network efficiency. We provide the optical connectivity expertise that is compatible with and enhances your switching and transport equipment.

The Trusted Partner

Customer service is our number one value. ProLabs has invested in people, labs and manufacturing capacity to ensure compatible products, and immediate answers to your questions. With Engineering and Manufacturing offices in the U.K. and U.S. augmented by field offices throughout the U.S., U.K. and Asia, ProLabs is able to be our customers best advocate 24 hours a day.



Contact Information

ProLabs US

Email: sales@prolabs.com

Telephone: 952-852-0252

ProLabs UK

Email: salessupport@prolabs.com

Telephone: +44 1285 719 600