

MMS1X00-NS400-NPC

Mellanox® MMS1X00-NS400 Compatible TAA 400GBase-DR4 QSFP112 Transceiver (SMF, 1310nm, 500m, MPO, DOM) CMIS 5.0

Features:

- Compliant with IEEE Std 802.3bs and 802.3ck on 400Gbps Optical and Electrical Interfaces
- Compliant with 400G-DR4 Optical Specifications
- 4x106.25G PAM4
- MPO-12 Receptacles
- CMIS 5.0 Interface
- Transmission Distance: Up to 500m SMF
- Compliant with QSFP112 MSA
- Single 3.3V Power Supply
- Operating Temperature: 0 to 70 Celsius
- RoHS Compliant and Lead-Free

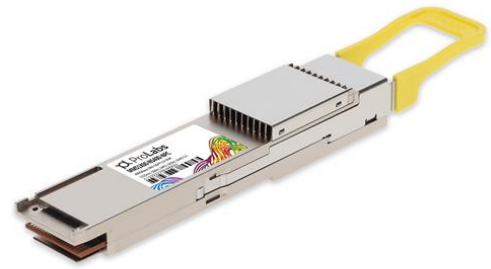

Applications:

- 400GBase Ethernet
- Access and Enterprise

Product Description

This Mellanox® compatible QSFP112 transceiver provides 400GBase-DR4 throughput up to 500m over single-mode fiber (SMF) using a wavelength of 1310nm via an MPO connector. It can operate at temperatures between 0 and 70C. Our transceiver is built to meet or exceed OEM specifications and is guaranteed to be 100% compatible with Mellanox®. It has been programmed, uniquely serialized, and tested for data-traffic and application to ensure that it will initialize and perform identically. All of our transceivers comply with Multi-Source Agreement (MSA) standards to provide seamless network integration. Additional product features include Digital Optical Monitoring (DOM) support which allows access to real-time operating parameters. This transceiver is Trade Agreements Act (TAA) compliant. We stand behind the quality of our products and proudly offer a limited lifetime warranty.

ProLabs' transceivers are RoHS compliant and lead-free.

TAA refers to the Trade Agreements Act (19 U.S.C. & 2501-2581), which is intended to foster fair and open international trade. TAA requires that the U.S. Government may acquire only "U.S.-made or designated country end products.")



Absolute Maximum Ratings

Parameter	Symbol	Min.	Typ.	Max.	Unit	Notes
Storage Temperature	Tstg	-40		85	°C	
Operating Case Temperature	Tc	0	25	70	°C	
Relative Humidity	RH	15		85	%	
Supply Voltage	Vcc	-0.5		3.6	V	
Data Rate	DR		53.125			
Modulation Format			PAM4			

Electrical Characteristics

Parameter	Symbol	Min.	Typ.	Max.	Unit	Notes
Power Supply Voltage	Vcc	3.135	3.3	3.465	V	
Power Supply Current	Icc			2.55	A	
Power Dissipation	P _{DISS}			8	W	
Transmitter						
Input Differential Impedance	ZIN		100		Ω	
Differential Data Input Swing	VIN,pp	180		900	mVp-p	
Receiver						
Output Differential Impedance	ZOUT		100		Ω	
Differential Data Input Swing	VOUT,pp	300		850	mVp-p	1

Notes:

1. Internally AC coupled but requires a external 100Ω differential load termination.

Optical Characteristics

Parameter	Symbol	Min.	Typ.	Max.	Unit	Notes
Transmitter						
Center Wavelength Range	λ_C	1304.5		1317.5	nm	
Side-Mode Suppression Ratio	SMSR	30			dB	
Average Launch Power Per Lane	P	-2.9		4	dBm	
Outer Optical Modulation Amplitude Per Lane	OMA _{outer}	-0.8		4.2	dBm	
Transmitter and Dispersion Penalty Eye Closure for PAM4 Per Lane	TDECQ			3.4	dB	
Launch Power in OMA _{outer} Minus TDECQ Per Lane (Minimum)		-2.2			dBm	
Extinction Ratio	ER	3.5			dB	
Average Launch Power of Off Transmitter	P _{off}			-15	dBm	
Optical Return Loss Tolerance	ORLT			21.4	dB	
Transmitter Reflectance				-26	dB	
Receiver						
Lane Wavelengths	Λ	1304.5		1317.5	nm	
Receiver Sensitivity Per Lane (OMA _{outer})				-4.4	dBm	1
Stressed Receiver Sensitivity (OMA _{outer}) Per Lane	OMA			-1.9	dBm	1
Receiver Overload (P _{avg})	POL	4			dBm	
Damage Threshold	POL	5			dBm	
Receive Power Per Lane (OMA _{outer})	OMA			4.2	dBm	
Receiver Reflectance	ORL			-26	dB	
LOS De-Assert	LOSD			-10	dBm	
LOS Assert	LOSA	-16			dBm	
LOS Hysteresis		0.5			dB	

Notes:

1. Measured with PRBS31Q test pattern @53.125GBd with PAM4 modulation and BER<2.4E⁻⁴.

Pin Descriptions

Pin	Symbol	Name/Description	Plug Sequence	Notes
1	GND	Transmitter Ground (Common with Receiver Ground).	1	1
2	Tx2-	Transmitter Inverted Data Input.	3	
3	Tx2+	Transmitter Non-Inverted Data Output.	3	
4	GND	Transmitter Ground (Common with Receiver Ground).	1	1
5	Tx4-	Transmitter Inverted Data Input.	3	
6	Tx4+	Transmitter Non-Inverted Data Output.	3	
7	GND	Transmitter Ground (Common with Receiver Ground).	1	1
8	ModSelL	Module Select.	3	
9	ResetL	Module Reset.	3	
10	VccRx	+3.3V Receiver Power Supply.	2	3
11	SCL	2-Wire Serial Interface Clock.	3	
12	SDA	2-Wire Serial Interface Data.	3	
13	GND	Transmitter Ground (Common with Receiver Ground).	1	1
14	Rx3+	Receiver Non-Inverted Data Output.	3	
15	Rx3-	Receiver Inverted Data Output.	3	
16	GND	Transmitter Ground (Common with Receiver Ground).	1	1
17	Rx1+	Receiver Non-Inverted Data Output.	3	
18	Rx1-	Receiver Inverted Data Output.	3	
19	GND	Transmitter Ground (Common with Receiver Ground).	1	1
20	GND	Transmitter Ground (Common with Receiver Ground).	1	1
21	Rx2-	Receiver Inverted Data Output.	3	
22	Rx2+	Receiver Non-Inverted Data Output.	3	
23	GND	Transmitter Ground (Common with Receiver Ground).	1	1
24	Rx4-	Receiver Inverted Data Output.	3	
25	Rx4+	Receiver Non-Inverted Data Output.	3	
26	GND	Transmitter Ground (Common with Receiver Ground).	1	1
27	ModPrsL	Module Present.	3	
28	IntL/RxLOS	Interrupt.	3	2
29	VccTx	+3.3V Transmitter Power Supply.	2	3
30	Vcc1	+3.3V Power Supply.	2	3
31	LPMoDe/TxDiS	Low-Power Mode.	3	
32	GND	Transmitter Ground (Common with Receiver Ground).	1	1
33	Tx3+	Transmitter Non-Inverted Data Input.	3	
34	Tx3-	Transmitter Inverted Data Output.	3	
35	GND	Transmitter Ground (Common with Receiver Ground).	1	1
36	Tx1+	Transmitter Non-Inverted Data Input.	3	
37	Tx1-	Transmitter Inverted Data Output.	3	
38	GND	Transmitter Ground (Common with Receiver Ground).	1	1

Notes:

1. QSFP112 uses common ground (GND) for all signals and supply (power). All are common within the QSFP DD module, and all module voltages are referenced to this potential unless otherwise noted. Connect these directly to the host board signal common ground plane. Each connector GND contact is rated for a maximum current of 500mA.
2. This is an open collector/drain output that, on the host board, requires a 4.7kΩ to 10kΩ pull-up resistor to the Host_Vcc.
3. VccRx, Vcc1, and VccTx shall be applied concurrently. For power classes 4 and above, the module differential loading of input voltage pads must not result in exceeding contact current limits. Each connector Vcc contact is rated for a maximum current of 1500mA.

Module Pad Layout

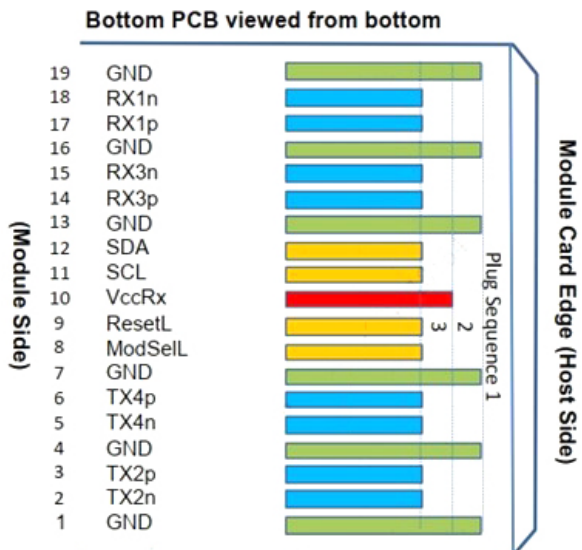
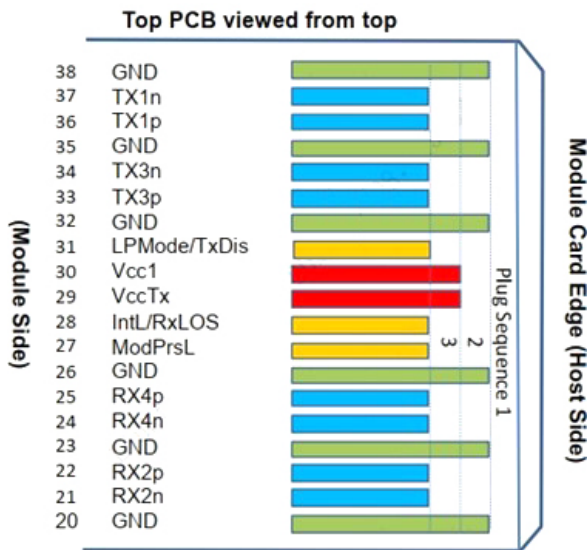

Recommended Host Board Power Supply Filter Network

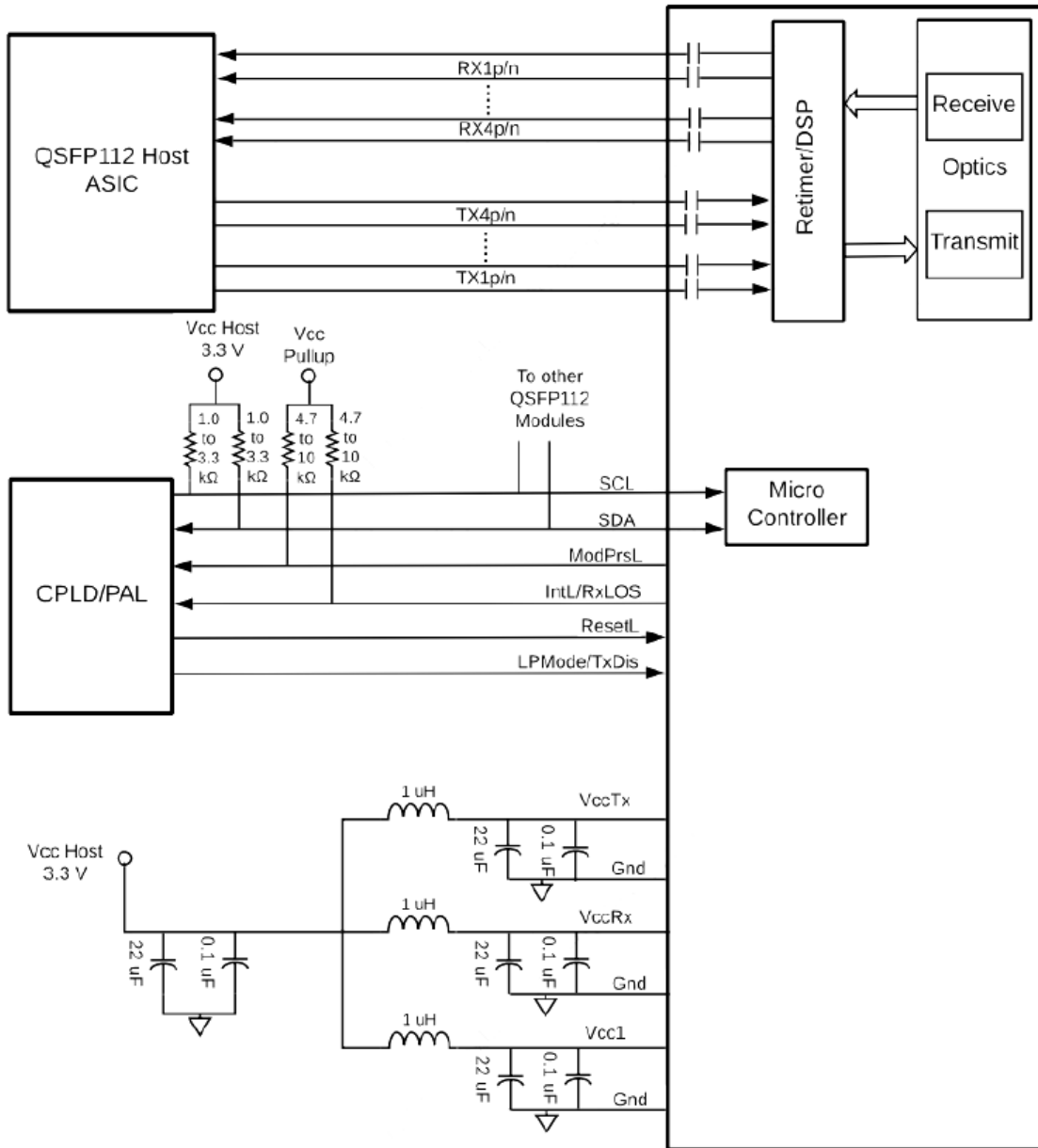

Mechanical Specifications

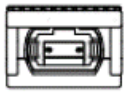

Unit:mm

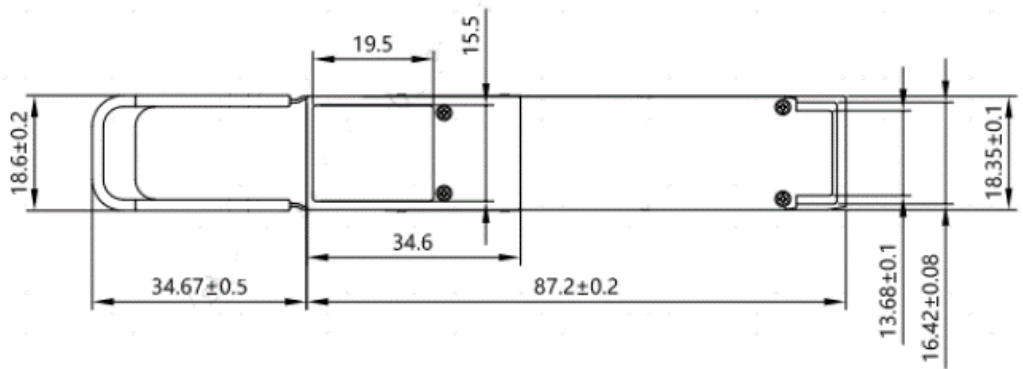
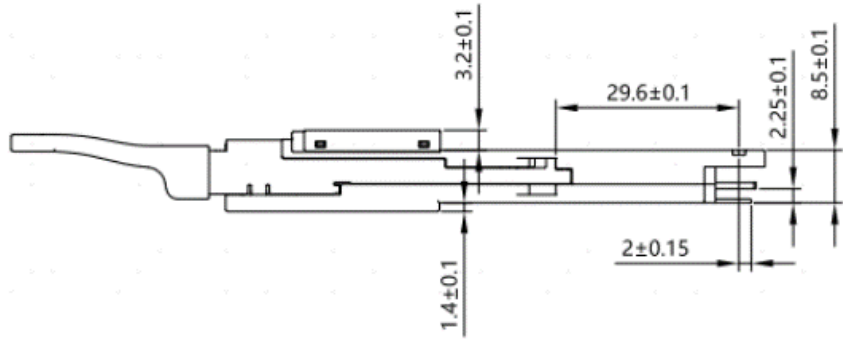
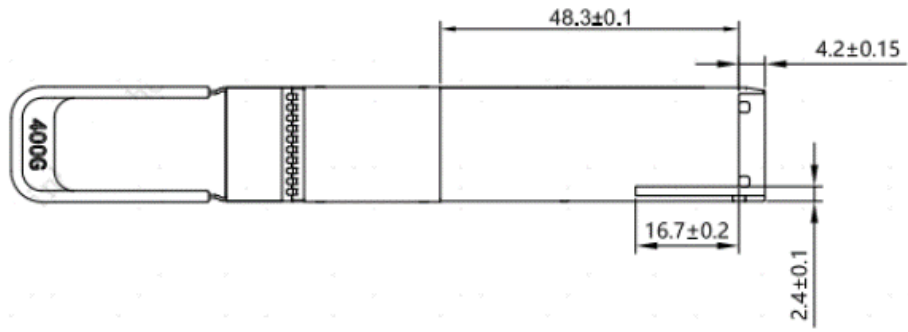

About ProLabs

Our extensive experience comes as standard. For over 20 years ProLabs has delivered optical connectivity solutions that give our customers freedom and choice through our ability to provide seamless interoperability. At the heart of our company is the ability to provide state-of-the-art optical transport and connectivity solutions that are compatible with more than 100 optical switching and transport platforms.

A Complete Portfolio of Network Solutions

ProLabs is focused on innovations in optical transport and connectivity. The combination of our knowledge of optics and networking equipment enables ProLabs to be your single source for optical transport and connectivity solutions from 100Mb to 1.6T while providing innovative solutions that increase network efficiency. We provide the optical connectivity expertise that is compatible with and enhances your switching and transport equipment.

The Trusted Partner

Customer service is our number one value. ProLabs has invested in people, labs and manufacturing capacity to ensure compatible products, and immediate answers to your questions. With Engineering and Manufacturing offices in the U.K. and U.S. augmented by field offices throughout the U.S., U.K. and Asia, ProLabs is able to be our customers best advocate 24 hours a day.



Contact Information

ProLabs US

Email: sales@prolabs.com

Telephone: 952-852-0252

ProLabs UK

Email: salessupport@prolabs.com

Telephone: +44 1285 719 600