

## QSFP112-400GB-FR4-MX-NPC

Mellanox® Compatible TAA 400GBase-FR4 QSFP112 Transceiver (SMF, 1310nm, 2km, LC, DOM, CMIS 5.0)

### Features:

- Compliant with 400GBASE-FR4
- Compliant with IEEE802.3ck Standard 400GAUI-4 C2M Electrical Interface
- Compliant with QSFP-DD MSA
- Duplex LC Connector
- CMIS 5.0
- Class 1 Laser
- 2-Wire Interface with Digital Diagnostic Monitoring
- Operating Temperature: 0 to 70 Celsius
- RoHS Compliant and Lead-Free

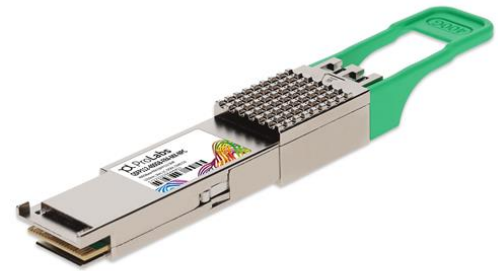

### Applications:

- 400GBase Ethernet
- Access and Enterprise

### Product Description

This Mellanox® compatible QSFP112 transceiver provides 400GBase-FR4 throughput up to 2km over single-mode fiber (SMF) using a wavelength of 1310nm via an LC connector. It can operate at temperatures between 0 and 70C. Our transceiver is built to meet or exceed OEM specifications and is guaranteed to be 100% compatible with Mellanox®. It has been programmed, uniquely serialized, and tested for data-traffic and application to ensure that it will initialize and perform identically. All of our transceivers comply with Multi-Source Agreement (MSA) standards to provide seamless network integration. Additional product features include Digital Optical Monitoring (DOM) support which allows access to real-time operating parameters. This transceiver is Trade Agreements Act (TAA) compliant. We stand behind the quality of our products and proudly offer a limited lifetime warranty.

ProLabs' transceivers are RoHS compliant and lead-free.

TAA refers to the Trade Agreements Act (19 U.S.C. & 2501-2581), which is intended to foster fair and open international trade. TAA requires that the U.S. Government may acquire only "U.S.-made or designated country end products.")



## Absolute Maximum Ratings

Parameter	Symbol	Min.	Typ.	Max.	Unit	Notes
Storage Temperature	Tstg	-40		85	°C	
Operating Case Temperature	Tc	0		70	°C	
Relative Humidity	RH	5		89	%	
Supply Voltage	Vcc	-0.5		3.6	V	
Signaling Rate Per Lane			53.125 ± 100ppm		Gbd	PAM4
Operating Distance		2		2000	m	

## Electrical Characteristics

Parameter	Symbol	Min.	Typ.	Max.	Unit	Notes
Power Supply Voltage	Vcc	3.135	3.3	3.465	V	
Instantaneous Peak Current at Hot Plug	Icc_IP			4000	mA	
Sustained Peak Current at Hot Plug	Icc_SP			3300	mA	
Maximum Power Dissipation	PD			10	W	
Maximum Power Dissipation (Low-Power Mode)	PD <sub>LP</sub>			1.5	W	
2-Wire Serial Interface Clock Rate				400	kHz	
Module Sinusoidal Power Supply Noise Tolerance 1kHz - 1MHz (Pk-Pk)				66	mVp-p	
Rx Differential Data Output Load			100		Ω	
<b>Transmitter</b>						
Differential Pk-Pk Input Voltage Tolerance (TP1a)		750			mV	
Pk-Pk AC Common-Mode Voltage Tolerance	Low-Frequency (VCMLF)			32	mV	
	Full-Band (VCMFB)			80		
Effective Return Loss	ERL	8.5			dB	
Differential Termination Mismatch				10	%	
Single-Ended Voltage Tolerance Range		-0.4		3.3	V	
DC Common-Mode Voltage Tolerance		-0.35		2.85	V	
Differential-Mode to Common-Mode Return Loss	RLcd		802.3ck 120G-2		dB	
<b>Receiver</b>						
Pk-Pk AC Common-Mode Voltage	Low-Frequency (VCMLF)			32	mV	
	Full-Band (VCMFB)			80		
Differential Pk-Pk Output Voltage	Short-Mode			600	mV	
	Long-Mode			845		

Eye Height	EH	15			mV	
Vertical Eye Closure	VEC			12	dB	
Effective Return Loss	ERL	8.5			dB	
Differential Termination Mismatch				10	%	
Transition Time		8.5			ps	
DC Common-Mode Voltage Tolerance		-0.35		2.85	V	
Common-Mode to Differential-Mode Return Loss	RLDc	802.3ck 120G-1			dB	
Low-Speed Signal						
Module Output SCL and SDA	VOL	0		0.4	V	
Module Input SCL and SDA	VIL	-0.3		Vcc*0.3	V	
	VIH	Vcc*0.7		Vcc+0.5	V	
LPMoDe/TxDis, ResetL, and ModSelL	VIL	-0.3		0.8	V	
	VIH	2		Vcc+0.3	V	
IntL/RxLOS	VOL	0		0.4	V	
	VOH	Vcc-0.5		Vcc+0.3	V	

## Optical Characteristics

Parameter	Symbol	Min.	Typ.	Max.	Unit	Notes
<b>Transmitter</b>						
Center Wavelength	$\lambda_C$	1264.5	1271	1277.5	nm	
		1284.5	1291	1297.5		
		1304.5	1311	1317.5		
		1324.5	1331	1337.5		
Side-Mode Suppression Ratio	SMSR	30			dB	
Average Launch Power Per Lane	AOP <sub>L</sub>	-3.2		4.4	dBm	1
Outer Optical Modulation Amplitude (OMA <sub>outer</sub> ) Per Lane	T <sub>OMA</sub>			3.7	dBm	
Outer Optical Modulation Amplitude (OMA <sub>outer</sub> ) Per Lane	T <sub>OMA</sub>	TDECQ < 1.4dB	-0.2			
		1.4 ≤ TDECQ ≤ 3.4dB	-1.6 + TDECQ			
Difference in Launch Power Between Any Two Lanes (OMA <sub>outer</sub> )	DP			3.9	dB	
Transmitter and Dispersion Eye Closure for PAM4 (TDECQ) Per Lane	TDECQ			3.4	dB	
Transmitter Eye Closure for PAM4 (TECQ)	TECQ			3.4	dB	
TDECQ - TECQ				2.5	dB	
Over/Under-Shoot				22	%	
Transmitter Power Excursion				1.8	dBm	

<b>Average Launch Power of Off Transmitter Per Lane</b>		Toff			-16	dBm	
<b>Extinction Ratio Per Lane</b>		ER	3.5			dB	
<b>Transmitter Transition Time</b>					17	ps	
<b>RIN<sub>17.1</sub>OMA</b>		RIN			-136	dB/Hz	
<b>Optical Return Loss Tolerance</b>		ORL			17.1	dB	
<b>Transmitter Reflectance</b>		TR			-26	dB	
<b>Receiver</b>							
<b>Center Wavelength</b>		$\lambda_C$	1264.5	1271	1277.5	nm	
			1284.5	1291	1297.5		
			1304.5	1311	1317.5		
			1324.5	1331	1337.5		
<b>Damage Threshold Per Lane</b>		AOP <sub>D</sub>	5.4			dBm	
<b>Average Receive Power Per Lane</b>		AOP <sub>R</sub>	-7.2		4.4	dBm	2
<b>Receive Power (OMAouter) Per Lane</b>		OMA <sub>R</sub>			3.7	dBm	
<b>Difference in Receive Power Between Any Two Lanes (OMAouter)</b>		DR			4.1	dB	
<b>Receiver Reflectance</b>		RR			-26	dB	
<b>Receiver Sensitivity (OMAouter) Per Lane</b>	<b>TECQ&lt;1.4dB</b>	SOMA			-4.6	dBm	
	<b>1.4≤TECQ≤3.4dB</b>				-6+TECQ		
<b>Stressed Receiver Sensitivity (OMAouter) Per Lane</b>		SRS			-2.6	dBm	3
<b>Stressed Eye Closure for PAM4 (SECQ)</b>				3.4		dB	
<b>OMAouter of Each Aggressor Lane</b>				1.4		dBm	

**Notes:**

1. Average launch power, per lane (minimum), is informative and not the principal indicator of signal strength.
2. Average receive power, per lane (minimum), is informative and not the principal indicator of signal strength.
3. Measured with conformance test signal at TP3 for the BER=2.4x10<sup>-4</sup>.

## Pin Descriptions

Pin	Symbol	Logic	Name/Description	Notes
1	GND		Module Ground.	1
2	Tx2-	CML-I	Transmitter Inverted Data Input.	
3	Tx2+	CML-I	Transmitter Non-Inverted Data Input.	
4	GND		Module Ground.	1
5	Tx4-	CML-I	Transmitter Inverted Data Input.	
6	Tx4+	CML-I	Transmitter Non-Inverted Data Input.	
7	GND		Module Ground.	1
8	ModSelL	LVTTTL-I	Module Select.	
9	ResetL	LVTTTL-I	Module Reset.	
10	VccRx		+3.3V Receiver Power Supply.	2
11	SCL	LVC MOS-I/O	2-Wire Serial Interface Clock.	
12	SDA	LVC MOS-I/O	2-Wire Serial Interface Data.	
13	GND		Module Ground.	1
14	Rx3+	CML-O	Receiver Non-Inverted Data Output.	
15	Rx3-	CML-O	Receiver Inverted Data Output.	
16	GND		Module Ground.	1
17	Rx1+	CML-O	Receiver Non-Inverted Data Output.	
18	Rx1-	CML-O	Receiver Inverted Data Output.	
19	GND		Module Ground.	1
20	GND		Module Ground.	1
21	Rx2-	CML-O	Receiver Inverted Data Output.	
22	Rx2+	CML-O	Receiver Non-Inverted Data Output.	
23	GND		Module Ground.	1
24	Rx4-	CML-O	Receiver Inverted Data Output.	
25	Rx4+	CML-O	Receiver Non-Inverted Data Output.	
26	GND		Module Ground.	1
27	ModPrsL	LVTTTL- O	Module Present.	
28	IntL/RxLOS	LVTTTL- O	Interrupt/Optional RxLOS.	
29	VccTx		+3.3V Transmitter Power Supply.	2
30	Vcc1		+3.3V Power Supply.	2
31	LPMoDe/TxDis	LVTTTL- I	Low-Power Mode/Optional Tx_Disable.	
32	GND		Module Ground.	1
33	Tx1+	CML-I	Transmitter Non-Inverted Data Input.	
34	Tx1-	CML-I	Transmitter Inverted Data Input.	
35	GND		Module Ground.	1

36	Tx1+	CML-I	Transmitter Non-Inverted Data Input.	
37	Tx1-	CML-I	Transmitter Inverted Data Input.	
38	GND		Module Ground.	1

**Pin-Out Details**

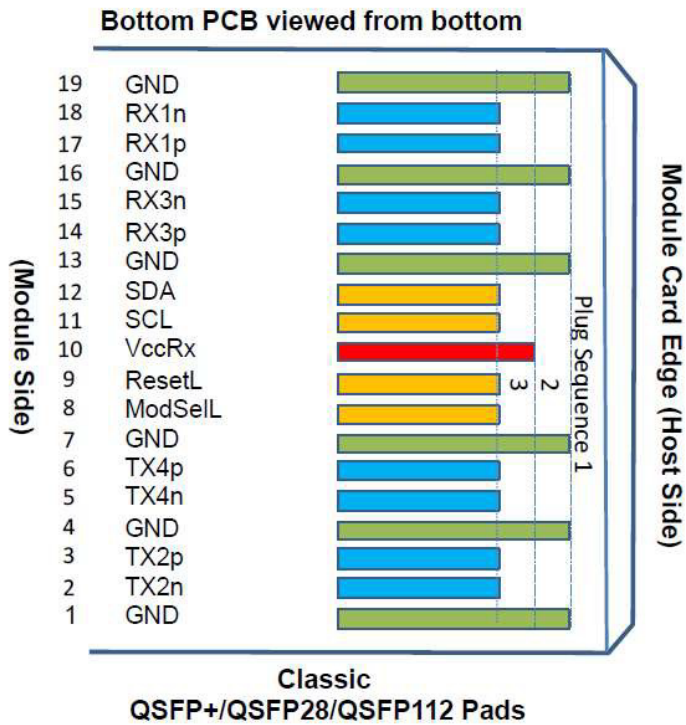
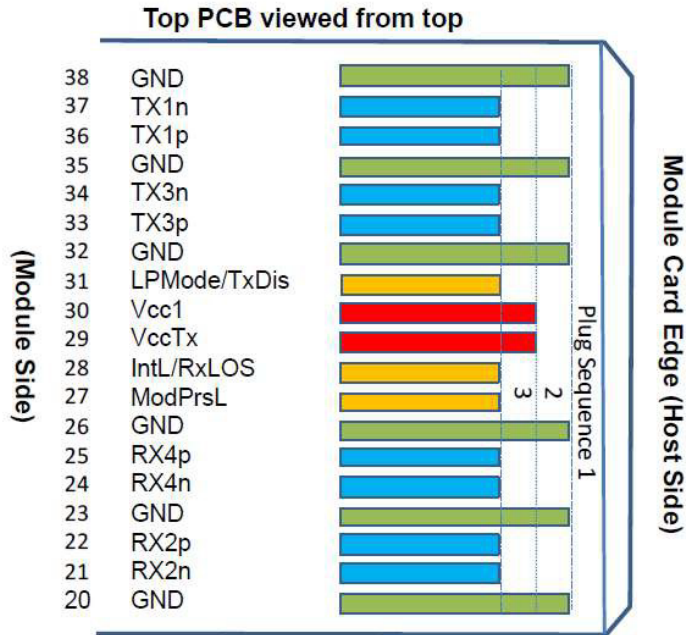

## Recommended Host Board Schematic

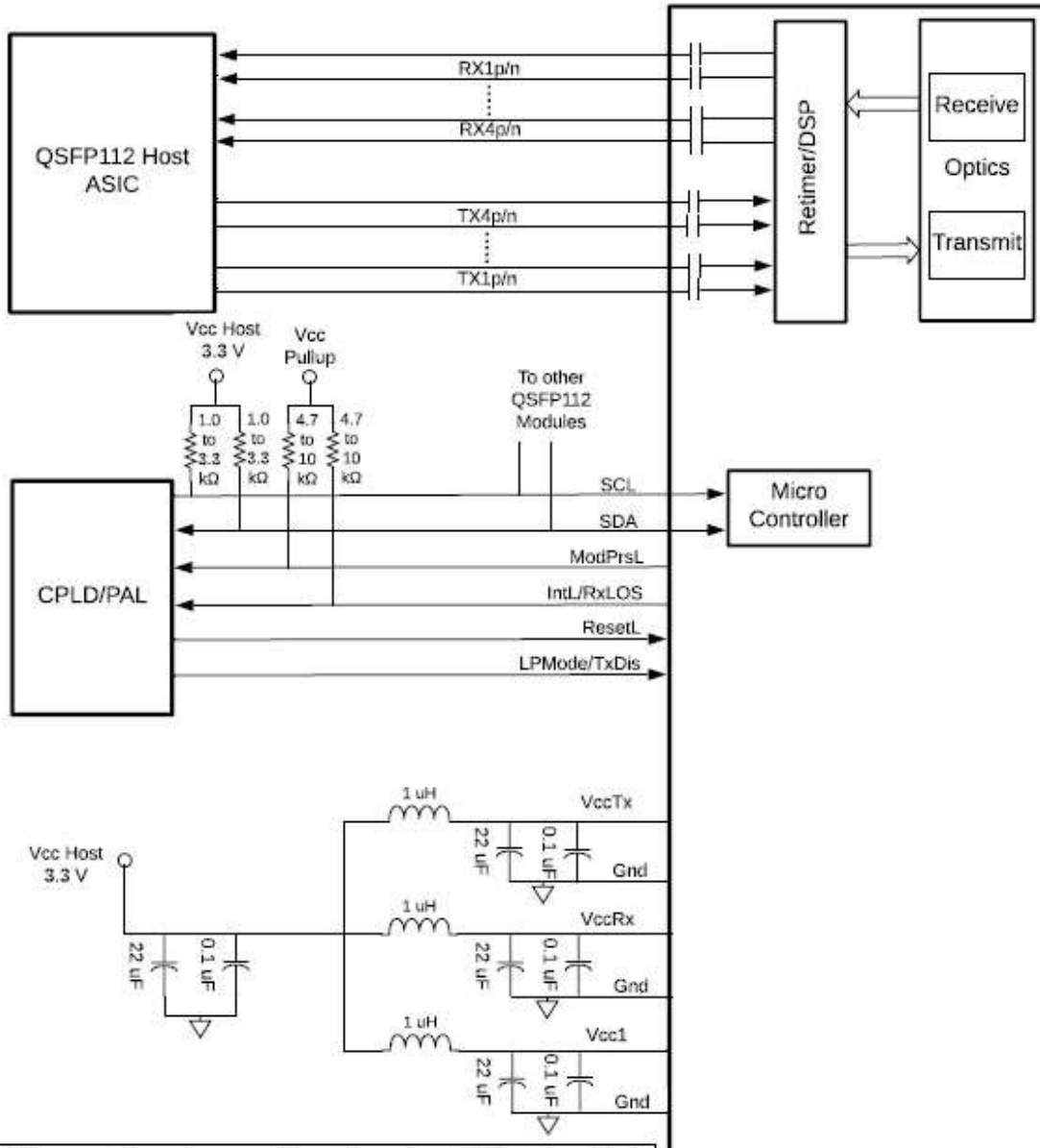

Note: Filter capacitors values are informative and application dependent, 0.1 μF capacitors should be placed in close proximity to power pads and may be duplicated for individual pads to provide additional high frequency filtering.

Note: Vcc1 may be connected to VccTx or VccRx within the module provided the applicable derating of the maximum current limit is used.

**QSF112 Optical Module**

# Mechanical Specifications

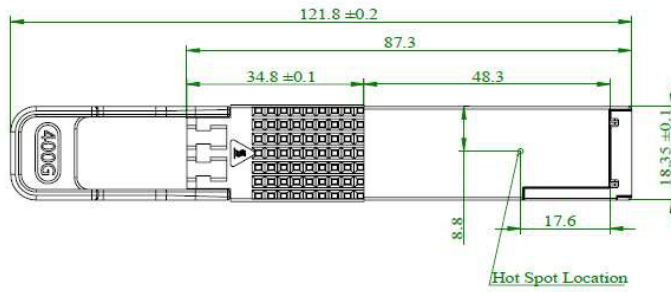
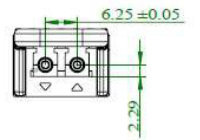
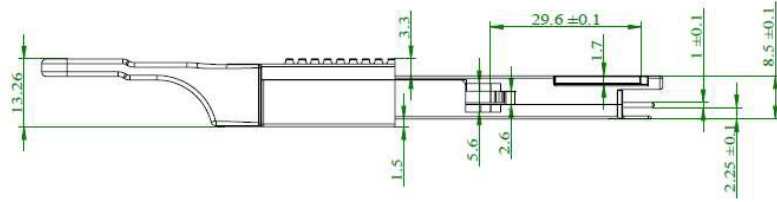
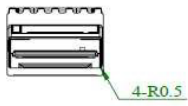
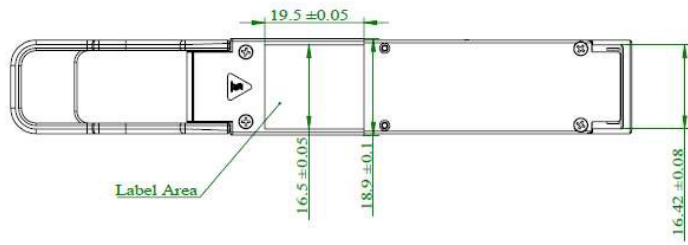

## About ProLabs

Our extensive experience comes as standard. For over 20 years ProLabs has delivered optical connectivity solutions that give our customers freedom and choice through our ability to provide seamless interoperability. At the heart of our company is the ability to provide state-of-the-art optical transport and connectivity solutions that are compatible with more than 100 optical switching and transport platforms.

## A Complete Portfolio of Network Solutions

ProLabs is focused on innovations in optical transport and connectivity. The combination of our knowledge of optics and networking equipment enables ProLabs to be your single source for optical transport and connectivity solutions from 100Mb to 1.6T while providing innovative solutions that increase network efficiency. We provide the optical connectivity expertise that is compatible with and enhances your switching and transport equipment.

## The Trusted Partner

Customer service is our number one value. ProLabs has invested in people, labs and manufacturing capacity to ensure compatible products, and immediate answers to your questions. With Engineering and Manufacturing offices in the U.K. and U.S. augmented by field offices throughout the U.S., U.K. and Asia, ProLabs is able to be our customers best advocate 24 hours a day.



## Contact Information

ProLabs US

Email: [sales@prolabs.com](mailto:sales@prolabs.com)

Telephone: 952-852-0252

ProLabs UK

Email: [salessupport@prolabs.com](mailto:salessupport@prolabs.com)

Telephone: +44 1285 719 600