

QSFP28-2QSFP28-AOC15M-MX-AO

Mellanox® Compatible TAA 100GBase-CU QSFP28 to 2xQSFP28 Active Optical Cable (850nm, MMF, 15m)

Features

- Single 3.3V Power Supply
- Low power consumption: 1.65W on 100G end
- Up to 25.78 Gbps per channel
- Operating temperature: 0 to 70 Celsius
- Hot Pluggable
- 0.95W on 50G end with all CDRs enabled
- RoHS compliant and Lead Free



Applications

- Data center: Switches, servers, storages and NIC adapters
- 50/100G Ethernet

Product Description

This is a Mellanox® Compatible 100GBase-AOC QSFP28 to 2xQSFP28 active optical cable that operates over multi-mode fiber with a maximum reach of 15.0m (49.2ft). At a wavelength of 850nm, it has been programmed, uniquely serialized, and data-traffic and application tested to ensure it is 100% compliant and functional. This active optical cable is TAA (Trade Agreements Act) compliant, and is built to comply with MSA (Multi-Source Agreement) standards. We stand behind the quality of our products and proudly offer a limited lifetime warranty.

AddOn's transceivers are RoHS compliant and lead-free.

TAA refers to the Trade Agreements Act (19 U.S.C. & 2501-2581), which is intended to foster fair and open international trade. TAA requires that the U.S. Government may acquire only "U.S.-made or designated country end products."



Absolute Maximum Ratings

Parameter	Symbol	Min.	Typ.	Max.	Unit	Notes
Storage Temperature	Tstg	-40		85	°C	1
Operating Case Temperature	Tc	0		70		
Power Supply Voltage	Vcc	0		3.6	V	
Relative Humidity	RH	0		85	%	
Data Rate (Per Lane)	DR		25.78		Gbps	
Minimum Bend Radius		30			mm	2
		60			mm	3
Length Tolerance		30m: +500mm/-0mm				

Notes:

1. Ambient.
2. Without tension.
3. Under maximum tension.

Electrical Characteristics

Parameter	Symbol	Min.	Typ.	Max.	Unit	Notes
Power Supply Voltage	Vcc	3.13	3.3	3.47	V	
Power Supply Current	100G End	Icc	500		mA	1
	50G End		290			
Power Consumption	100G End		1.65	1.73	W	1
	50G End		0.95	1		
Transmitter						
Input Differential Impedance	RIN	90	100	110	Ω	
Differential Data Input Voltage	VIN,pp	200		900	mV	
Receiver						
Output Differential Impedance	ROUT	90	100	110	Ω	
Differential Data Output Voltage	VOUT,pp		800		mV	
Bit Error Ratio				10 ⁻⁸		2

Notes:

1. Per end.
2. Pre-FEC Bit Error Ratio with a PRBS 2³¹ – 1 test pattern.

Pin Descriptions

Pin	Symbol	Name/Description	Notes
1	GND	Module Ground.	1
2	Tx2-	Transmitter Inverted Data Input.	
3	Tx2+	Transmitter Non-Inverted Data Input.	
4	GND	Module Ground.	1
5	Tx4-	Transmitter Inverted Data Input.	
6	Tx4+	Transmitter Non-Inverted Data Input.	
7	GND	Module Ground.	1
8	ModSelL	Module Select.	
9	ResetL	Module Reset.	
10	VccRx	+3.3V Receiver Power Supply.	2
11	SCL	2-Wire Serial Interface Clock.	
12	SDA	2-Wire Serial Interface Data.	
13	GND	Module Ground.	1
14	Rx3+	Receiver Non-Inverted Data Output.	
15	Rx3-	Receiver Inverted Data Output.	
16	GND	Module Ground.	1
17	Rx1+	Receiver Non-Inverted Data Output.	
18	Rx1-	Receiver Inverted Data Output.	
19	GND	Module Ground.	1
20	GND	Module Ground.	1
21	Rx2-	Receiver Inverted Data Output.	
22	Rx2+	Receiver Non-Inverted Data Output.	
23	GND	Module Ground.	1
24	Rx4-	Receiver Inverted Data Output.	
25	Rx4+	Receiver Non-Inverted Data Output.	
26	GND	Module Ground.	1
27	ModPrsL	Module Present.	
28	IntL	Interrupt.	
29	VccTx	+3.3V Transmitter Power Supply.	2
30	Vcc1	+3.3V Power Supply.	2
31	LPMODE	Low-Power Mode.	3
32	GND	Module Ground.	1
33	Tx3+	Transmitter Non-Inverted Data Input.	
34	Tx3-	Transmitter Inverted Data Input.	
35	GND	Module Ground.	1
36	Tx1+	Transmitter Non-Inverted Data Input.	
37	Tx1-	Transmitter Inverted Data Input.	
38	GND	Module Ground.	1

Notes:

1. GND is the symbol for signal and supply (power) common for the QSFP module. All are common within the QSFP module, and all module voltages are referenced to this potential unless otherwise noted. Connect these directly to the host board signal-common ground plane.
2. VccRx, Vcc1, and VccTx are the receiver and transmitter power supplies and shall be applied concurrently. VccRx, Vcc1, and VccTx may be internally connected within the QSFP transceiver module in any combination. The connector pins are each rated for a maximum current of 500mA.
3. Not in use.

Electrical Pin-Out Details

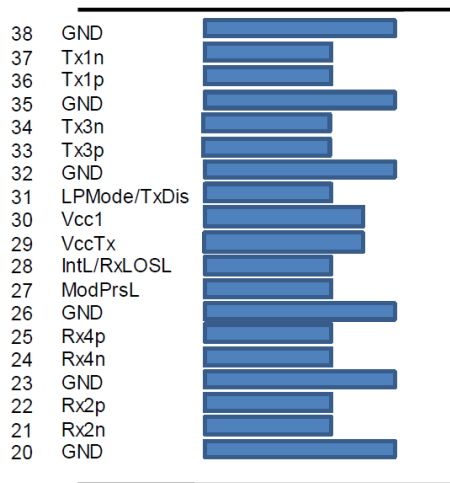

Top Side
Viewed From Top

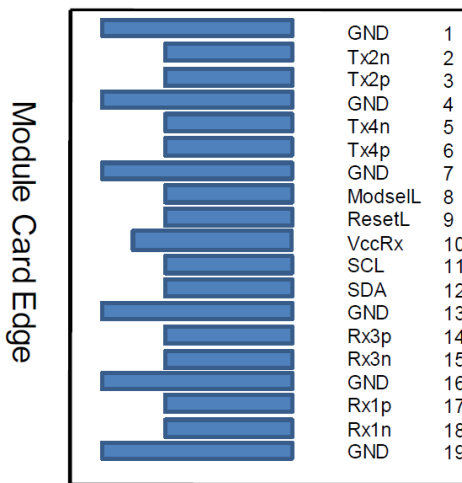

Bottom Side
Viewed From Bottom

Module Card Edge

Recommended Power Supply Filter

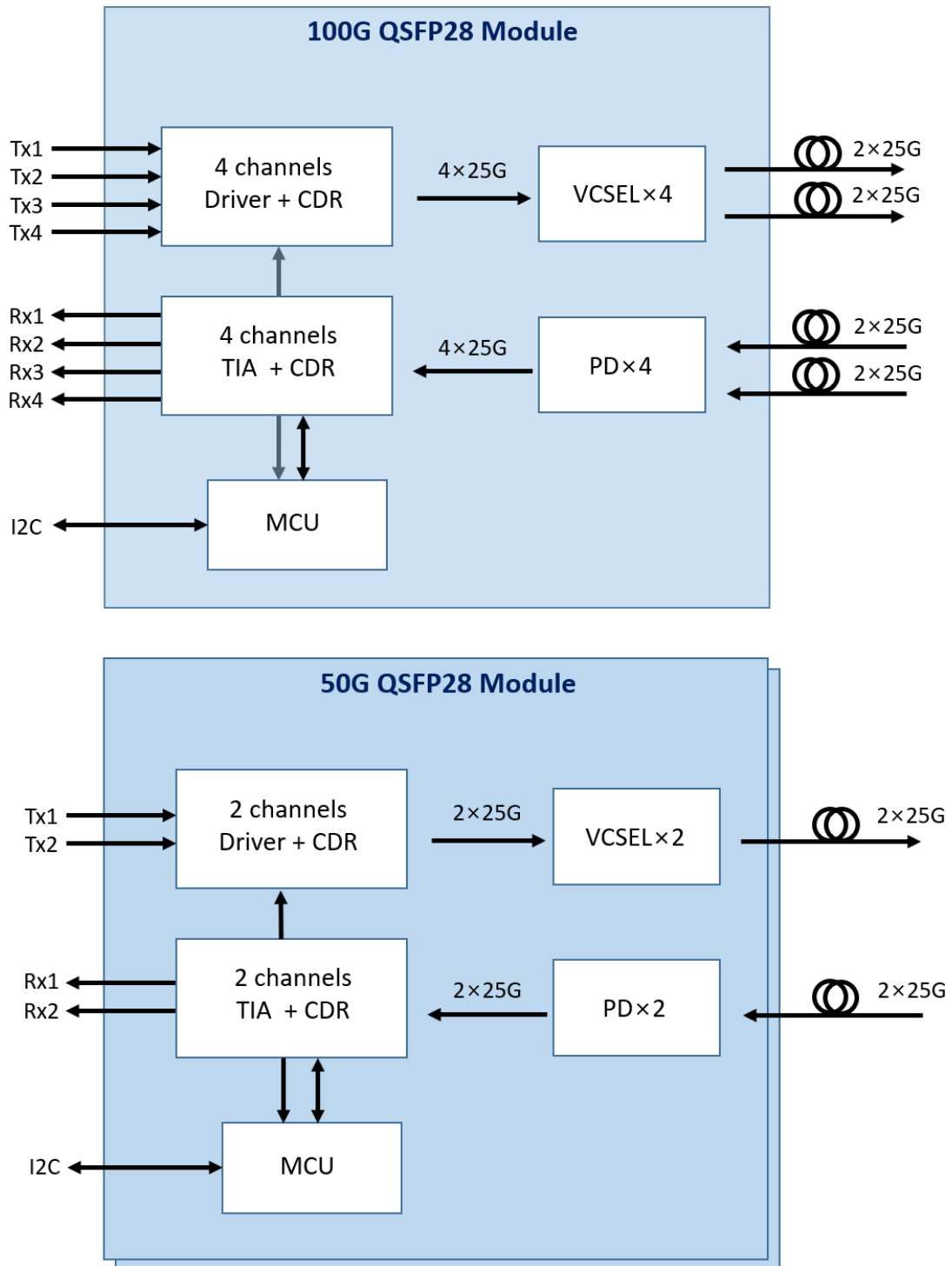

Mechanical Specifications

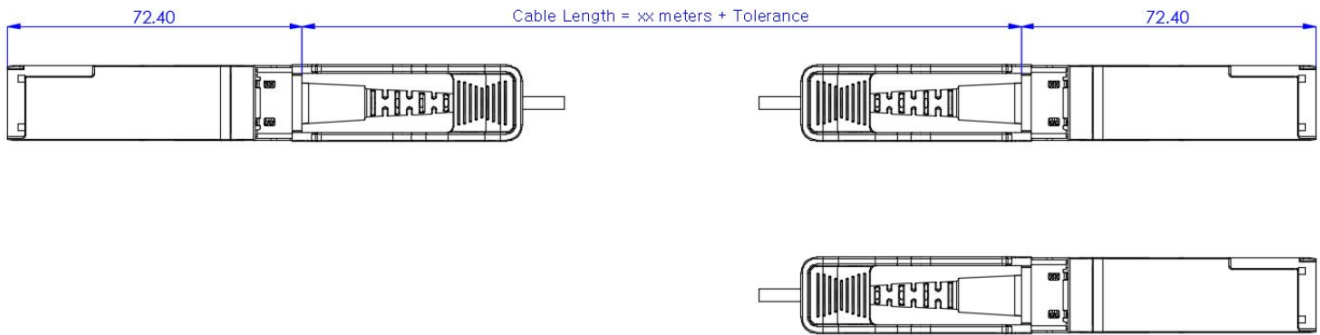
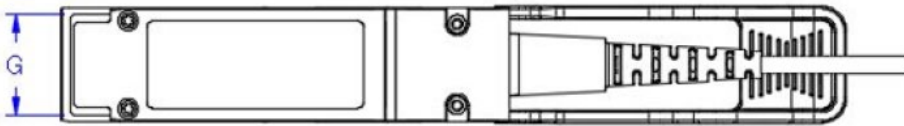
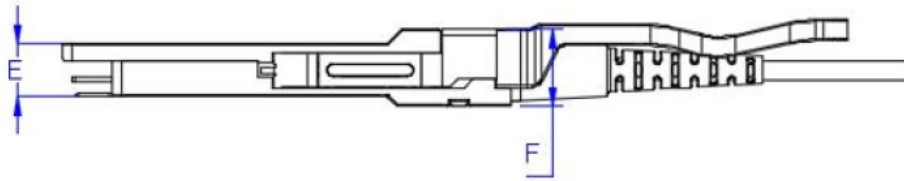
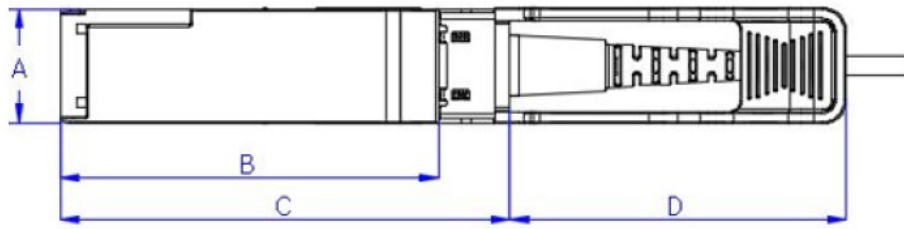

Num.	DIM (mm)	TOL (mm)
A	18.35	±0.10
B	60.90	±0.20
C	72.40	±0.20
D	53.80	±0.30
E	8.50	±0.10
F	12.55	±0.20
G	16.40	±0.10

About AddOn Networks

In 1999, AddOn Networks entered the market with a single product. Our founders fulfilled a severe shortage for compatible, cost-effective optical transceivers that compete at the same performance levels as leading OEM manufacturers. Adhering to the idea of redefining service and product quality not previously had in the fiber optic networking industry, AddOn invested resources in solution design, production, fulfillment, and global support.

Combining one of the most extensive and stringent testing processes in the industry, an exceptional free tech support center, and a consistent roll-out of innovative technologies, AddOn has continually set industry standards of quality and reliability throughout its history.

Reliability is the cornerstone of any optical fiber network and is ingrained in AddOn's DNA. It has played a key role in nurturing the long-term relationships developed over the years with customers. AddOn remains committed to exceeding industry standards with certifications ranging from NEBS Level 3 to ISO 9001:2015 with every new development while maintaining the signature reliability of its products.



U.S. Headquarters

Email: sales@addonnetworks.com

Telephone: +1 877.292.1701

Fax: 949.266.9273

Europe Headquarters

Email: salesemea@addonnetworks.com

Telephone: +44 1285 842070