

MFA2P10-A005-AO

Mellanox® MFA2P10-A005 Compatible TAA Compliant 25GBase-AOC SFP28 to SFP28 Active Optical Cable (850nm, MMF, 5m)

Features

- Hot-pluggable SFP28 form factor
- 850nm VCSEL laser and PIN photo-detector
- Supports 25Gbps data rate
- Single 3.3V power supply
- Power dissipation < 1W
- Internal CDR on both Transmitter and receiver channel
- Operating Case temperature: 0 to 70 Celsius
- Digital diagnostics functions are available via the I2C interface
- RoHS Compliant and Lead-Free



Applications

- 25Gbase-SR Ethernet

Product Description

This is a Mellanox® MFA2P10-A005 Compatible 25GBase-AOC SFP28 to SFP28 active optical cable that operates over active fiber with a maximum reach of 5m. It has been programmed, uniquely serialized, and data-traffic and application tested to ensure it is 100% compliant and functional. We stand behind the quality of our products and proudly offer a limited lifetime warranty. This cable is TAA (Trade Agreements Act) compliant and is built to comply with MSA (Multi-Source Agreement) standards.

AddOn's transceivers are RoHS compliant and lead-free.

TAA refers to the Trade Agreements Act (19 U.S.C. & 2501-2581), which is intended to foster fair and open international trade. TAA requires that the U.S. Government may acquire only "U.S. – made or designated country end products."



General Specifications

Parameter	Symbol	Min	Typ.	Max.	Unit
Storage Temperature		-40		85	°C
Operating Case Temperature	T _c	0		70	°C
Power Supply Voltage	V _{cc}	3.13	3.3	3.47	V
Supply Voltage	V _{cc}	0		3.6	V
Storage Temperature	T _{stg}	-40		85	°C
Operating Humidity		5		85	%

Optical Characteristics

Parameter	Symbol	Min.	Typ.	Max.	Unit	Notes
Transmitter						
Data Rate	BR		25.78		Gbps	
Centre Wavelength	λ _c	840	850	860	nm	
Spectral Width (-20dB)	σ			0.6	nm	
Average Output Power	P _{avg}	-8.4		2.4	dBm	
Optical Power OMA	P _{OMA}	-6.4		3	dBm	
Extinction Ratio	ER	2			dB	
Differential data input swing	V _{IN,PP}	40		1000	mV	
Input Differential Impedance	Z _{IN}	90	100	110	Ω	
TX Disable	Disable		2.0		V _{cc}	V
	Enable		0		0.8	V
TX Fault	Fault		2.0		V _{cc}	V
	Normal		0		0.8	V
Receiver						
Data Rate	BR		25.78		Gbps	
Centre Wavelength	λ _c	840	850	860	nm	
Receiver Sensitivity (OMA)	P _{sens}			-10	dBm	
Stressed Sensitivity (OMA)				-5.2	dBm	
Receiver Power (OMA)				3	dBm	
LOS De-Assert	LOS _D			-13	dBm	
LOS Assert	LOS _A	-30			dBm	
LOS Hysteresis		0.5			dB	
Differential data output swing	V _{out,PP}	500		1130	mV	
LOS	High		2.0		V _{cc}	V
	Low			0.8	V	V

Pin Descriptions

Pin	Logic	Symbol	Name/Description	Notes
1		VeeT	Transmitter Ground.	
2	LV-TTL-O	TX_Fault	N/A	1
3	LV-TTL-I	TX_DIS	Transmitter Disable.	
4	LV-TTL-I/O	SDA	2-Wire Serial Data.	
5	LV-TTL-I	SCL	2-Wire Serial Clock.	
6		MOD_DEF0	Module present, connect to VeeT.	
7	LV-TTL-I	RS0	N/A	1
8	LV-TTL-O	LOS	LOS of Signal.	
9	LV-TTL-I	RS1	N/A	1
10		VeeR	Receiver Ground.	
11		VeeR	Receiver Ground.	
12	CML-O	RD-	Receiver Data Inverted.	
13	CML-O	RD+	Receiver Data Non-inverted.	
14		VeeR	Receiver Ground.	
15		VccR	Receiver Supply +3.3V.	
16		VccT	Transmitter Supply +3.3V.	
17		VeeT	Transmitter Ground.	
18	CML-I	TD+	Transmitter Data Non-Inverted.	
19	CML_I	TD-	Transmitter Data Inverted.	
20		VeeT	Transmitter Ground.	

Note:

1. Signals not supported in SFP28 Copper pulled-down to VeeT with 30kΩ resistor.

Host Board

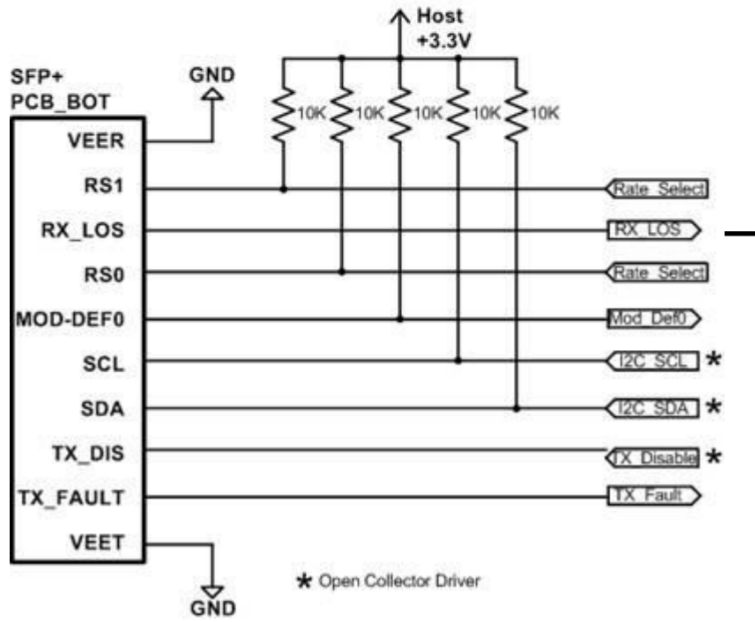

Mechanical Specification



About AddOn Networks

In 1999, AddOn Networks entered the market with a single product. Our founders fulfilled a severe shortage for compatible, cost-effective optical transceivers that compete at the same performance levels as leading OEM manufacturers. Adhering to the idea of redefining service and product quality not previously had in the fiber optic networking industry, AddOn invested resources in solution design, production, fulfillment, and global support.

Combining one of the most extensive and stringent testing processes in the industry, an exceptional free tech support center, and a consistent roll-out of innovative technologies, AddOn has continually set industry standards of quality and reliability throughout its history.

Reliability is the cornerstone of any optical fiber network and is engrained in AddOn's DNA. It has played a key role in nurturing the long-term relationships developed over the years with customers. AddOn remains committed to exceeding industry standards with certifications from ranging from NEBS Level 3 to ISO 9001:2005 with every new development while maintaining the signature reliability of its products.



U.S. Headquarters

Email: sales@addonnetworks.com

Telephone: +1 877.292.1701

Fax: 949.266.9273

Europe Headquarters

Email: salesupportemea@addonnetworks.com

Telephone: +44 1285 842070