

SFP-1GB-DW4552-120-AV-C

ADVA® Compatible TAA 1000Base-DWDM SFP+ Transceiver 50GHz (SMF, 1541.35nm to 1535.82nm, 120km, LC, DOM)

Features:

- EML Tunable Transmitter
- Hot Pluggable
- DWDM with 100GHz ITU Grid
- Up to 1.25Gbps Bi-directional Data Links
- SFP MSA Compliant
- Duplex LC Connector
- Up to 120km on 9/125um SMF
- Class 1 Laser Safety Certified
- Operating Temperature: 0 to 70 Celsius
- RoHS Compliant and Lead-Free



Applications:

- Gigabit Ethernet over DWDM
- Access, Metro and Enterprise

Product Description

This ADVA® compatible SFP transceiver provides 1000Base-DWDM throughput up to 120km over single-mode fiber (SMF) using a wavelength of 1541.35nm to 1535.82nm via an LC connector. It can operate at temperatures between 0 and 70C. Our transceiver is built to meet or exceed OEM specifications and is guaranteed to be 100% compatible with ADVA®. It has been programmed, uniquely serialized, and tested for data-traffic and application to ensure that it will initialize and perform identically. All of our transceivers comply with Multi-Source Agreement (MSA) standards to provide seamless network integration. Additional product features include Digital Optical Monitoring (DOM) support which allows access to real-time operating parameters. This transceiver is Trade Agreements Act (TAA) compliant. We stand behind the quality of our products and proudly offer a limited lifetime warranty.

ProLabs' transceivers are RoHS compliant and lead-free.

TAA refers to the Trade Agreements Act (19 U.S.C. & 2501-2581), which is intended to foster fair and open international trade. TAA requires that the U.S. Government may acquire only "U.S.-made or designated country end products.")



Channel Wavelengths

Channel	Frequency (THz)	Wavelength (nm)
CH20-CH28	192.00-192.80	1561.42-1554.94
CH29-CH36	192.90-193.60	1554.13-1548.51
CH37-CH44	193.70-194.40	1547.72-1542.14
CH45-CH52	194.50-195.20	1541.35-1535.82
CH53-CH60	195.30-196.00	1535.04-1529.55

Absolute Maximum Ratings

Parameter	Symbol	Min.	Typ.	Max.	Unit	Notes
Data Rate	DR			1.25	Gbps	
Operating Temperature	Tc	0		70	°C	
Storage Temperature	Tstg	-40		85	°C	
Maximum Voltage	Vcc	-0.5		4	V	

Electrical Characteristics

Parameter	Symbol	Min.	Typ.	Max.	Unit	Notes
Supply Current	Icc			606	mA	
Input Voltage	Vcc	3.135	3.3	3.465	V	
Power Dissipation	PD			2.0	W	
Transmitter						
Input Differential Impedance	ZIN		100		Ω	
Differential Data Input Swing	VIN,pp	180		900	mVp-p	
Transmit Disable Voltage	VD	2.0		Vcc+0.3	V	
Transmit Enable Voltage	VE	0		0.8	V	
Receiver						
Differential Output Impedance	ZOUT		100		Ω	
Differential Data Output Swing	VOUT,pp	450	600	900	mV	
LOS Assert Voltage	VLOSA	2.0		Vcc	V	
LOS De-Assert Voltage	VLOSD	0		0.8	V	

Notes:

1. For the electrical power interface.

Optical Characteristics

Parameter	Symbol	Min.	Typ.	Max.	Unit	Notes
Transmitter						
Launch Optical Power	Po	-1.0		4.0	dBm	1
Center Wavelength	λ_C	1554.94		1561.42	nm	
Center Wavelength Spacing			100		GHz	
Center Wavelength Deviation	$\Delta\lambda_C$	-12.5		12.5	GHz	
Wavelength Tuning Time				2	seconds	
Extinction Ratio	ER	9			dB	2
Side-Mode Suppression Ratio	SMSR	30			dB	
POUT @Tx_Disable Asserted	Poff			-30	dBm	1
Receiver						
Optical Center Wavelength	λ_C	1260		1620	nm	
Receiver Sensitivity @120km	S			-30	dBm	3
Receiver Overload	POL	-7			dBm	
Optical Return Loss	ORL			-27	dB	
LOS Assert	LOSA	-45			dBm	
LOS De-Assert	LOSD			-31	dBm	
LOS Hysteresis	LOSH	0.5			dB	

Notes:

1. The optical power is launched into 9/125 μ m SMF.
2. Measured with a PRBS7 test pattern @1.25Gbps.
3. Measured with a PRBS7 test pattern @1.25Gbps. BER=1E⁻¹².

Pin Descriptions

Pin	Symbol	Name/Description	Notes
1	VeeT	Transmitter Ground.	1
2	Tx_Fault	Transmitter Fault (LVTTTL-O). "High" indicates a fault condition.	2
3	Tx_Disable	Transmitter Disable (LVTTTL-I). "High" or "open" disables the transmitter.	3
4	SDA	2-Wire Serial Interface Data (LVCMOS-I/O) (MOD-DEF2).	4
5	SCL	2-Wire Serial Interface Clock (LVCMOS-I/O) (MOD-DEF1).	4
6	MOD_ABS	Module Absent Output. Connected to the VeeT or VeeR in the module.	5
7	RS0	No Connection Required.	
8	Rx_LOS	Receiver Loss of Signal (LVTTTL-O).	2
9	RS1	No Connection Required.	
10	VeeR	Receiver Ground.	1
11	VeeR	Receiver Ground.	1
12	RD-	Receiver Inverted Data Out. CML-O.	
13	RD+	Receiver Data Out. CML-O.	
14	VeeR	Receiver Ground.	
15	VccR	+3.3V Receiver Power Supply.	
16	VccT	+3.3V Transmitter Power Supply.	
17	VeeT	Transmitter Ground.	1
18	TD+	Transmitter Data In. CML-I.	
19	TD-	Transmitter Inverted Data In. CML-I.	
20	VeeT	Transmitter Ground.	1

Notes:

1. The module signal grounds are isolated from the module case.
2. This is an open collector/drain output that, on the host board, requires a 4.7k Ω to 10k Ω pull-up resistor to the Host_Vcc.
3. This input is internally biased "high" with a 4.7k Ω to 10k Ω pull-up resistor to the VccT.
4. 2-wire serial interface clock and data line requires an external pull-up resistor.
5. This is a ground return that, on the host board, requires a 4.7k Ω to 10k Ω pull-up resistor to the Host_Vcc.

Electrical Pad Layout

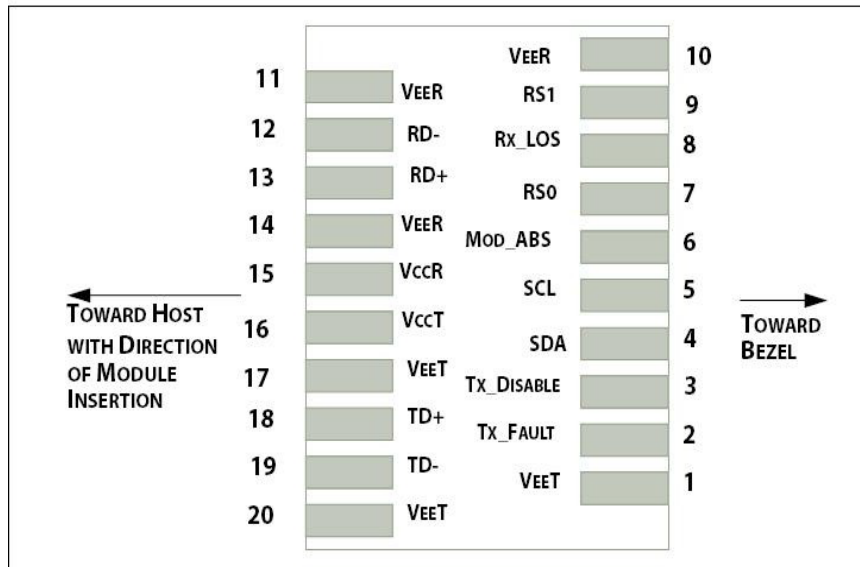

Recommended Host Board Supply Filter Network

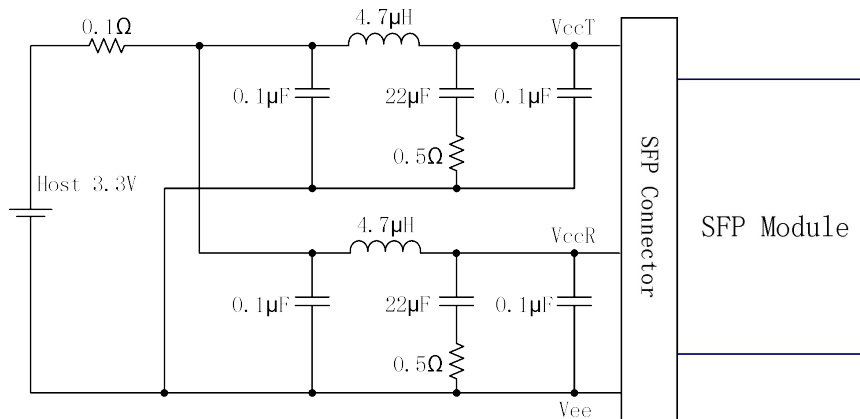

Block Diagram of Transceiver

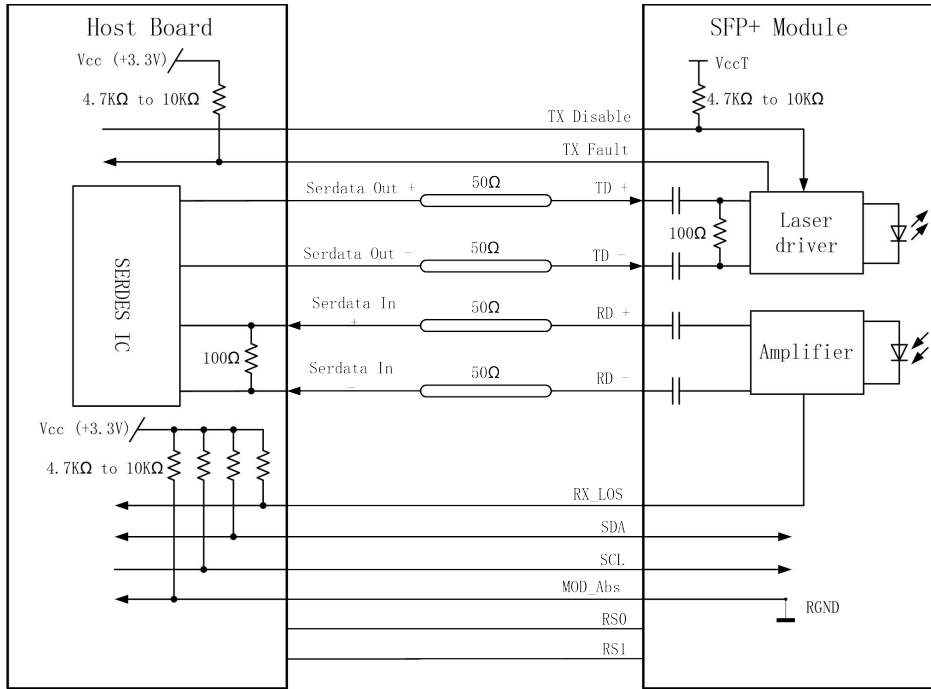

Mechanical Specifications

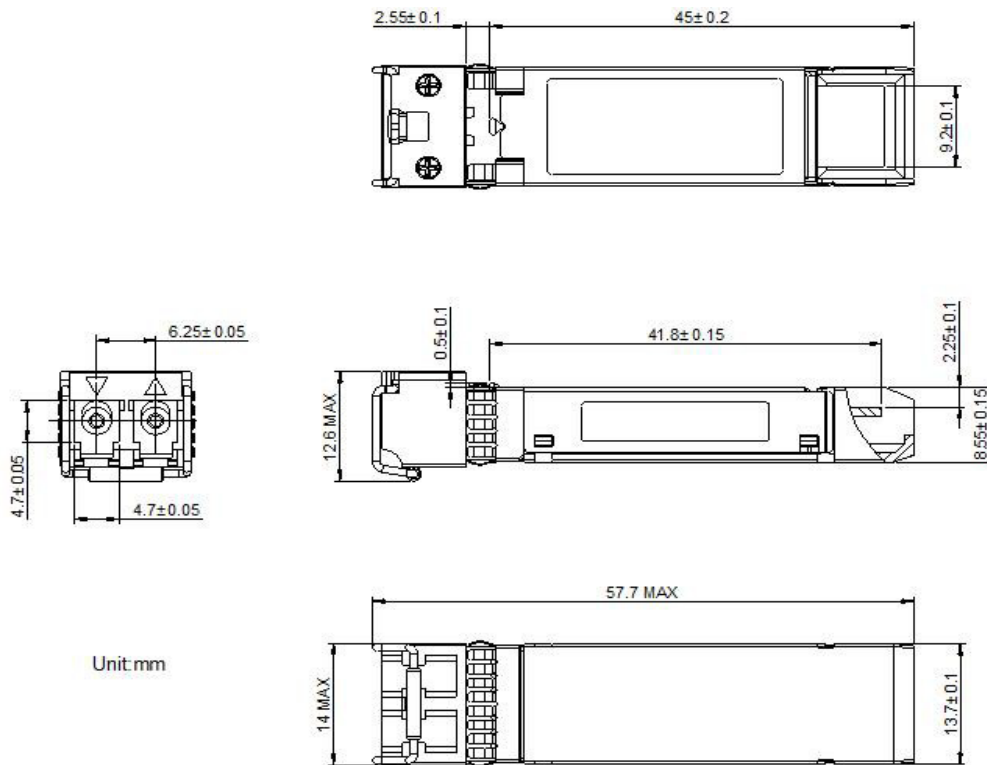

About ProLabs

Our extensive experience comes as standard. For over 20 years ProLabs has delivered optical connectivity solutions that give our customers freedom and choice through our ability to provide seamless interoperability. At the heart of our company is the ability to provide state-of-the-art optical transport and connectivity solutions that are compatible with more than 100 optical switching and transport platforms.

A Complete Portfolio of Network Solutions

ProLabs is focused on innovations in optical transport and connectivity. The combination of our knowledge of optics and networking equipment enables ProLabs to be your single source for optical transport and connectivity solutions from 100Mb to 1.6T while providing innovative solutions that increase network efficiency. We provide the optical connectivity expertise that is compatible with and enhances your switching and transport equipment.

The Trusted Partner

Customer service is our number one value. ProLabs has invested in people, labs and manufacturing capacity to ensure compatible products, and immediate answers to your questions. With Engineering and Manufacturing offices in the U.K. and U.S. augmented by field offices throughout the U.S., U.K. and Asia, ProLabs is able to be our customers best advocate 24 hours a day.



Contact Information

ProLabs US

Email: sales@prolabs.com

Telephone: 952-852-0252

ProLabs UK

Email: salessupport@prolabs.com

Telephone: +44 1285 719 600