

## 1061705850-02-C

ADVA® 1061705850-02 Compatible TAA 1000Base-LX SFP Transceiver (SMF, 1310nm, 10km, LC, DOM, -40 to 85C)

### Features:

- INF-8074 and SFF-8472 Compliance
- Duplex LC Connector
- Single-mode Fiber
- Industrial Temperature -40 to 85 Celsius
- Hot Pluggable
- Metal with Lower EMI
- Excellent ESD Protection
- RoHS Compliant and Lead Free



### Applications:

- 1000Base Ethernet
- Access and Enterprise

### Product Description

This ADVA® 1061705850-02 compatible SFP transceiver provides 1000Base-LX throughput up to 10km over single-mode fiber (SMF) using a wavelength of 1310nm via an LC connector. It is guaranteed to be 100% compatible with the equivalent ADVA® transceiver. This easy to install, hot swappable transceiver has been programmed, uniquely serialized and data-traffic and application tested to ensure that it will initialize and perform identically. Digital optical monitoring (DOM) support is also present to allow access to real-time operating parameters. This transceiver is Trade Agreements Act (TAA) compliant. We stand behind the quality of our products and proudly offer a limited lifetime warranty.

ProLabs' transceivers are RoHS compliant and lead-free.

TAA refers to the Trade Agreements Act (19 U.S.C. & 2501-2581), which is intended to foster fair and open international trade. TAA requires that the U.S. Government may acquire only "U.S. – made or designated country end products."



## Absolute Maximum Ratings

Parameter	Symbol	Min.	Max.	Unit
Maximum Supply Voltage	V <sub>CC</sub>	-0.5	4.0	V
Storage Temperature	T <sub>stg</sub>	-40	85	°C
Operating Case Temperature	T <sub>c</sub>	-40	85	°C
Operating Humidity	RH	5	85	%
Receiver Power	R <sub>MAX</sub>		0	dBm
Maximum Bitrate	B <sub>max</sub>		1.25	Gbps

## Electrical Characteristics (T<sub>c</sub>=25°C, V<sub>CC</sub>=3.3 Volts)

Parameter	Symbol	Min.	Typ.	Max.	Unit	Notes
Power Supply Voltage	V <sub>CC</sub>	3.15	3.30	3.43	V	
Power Supply Current	I <sub>CC</sub>			303	mA	
Power Consumption				1	W	
<b>Transmitter</b>						
Differential Data Input Swing	V <sub>IN,pp</sub>	120		850	mV	
Input Differential Impedance	Z <sub>IN</sub>	80	100	120	Ω	
<b>Receiver</b>						
Differential Data Output Swing	V <sub>OUT,pp</sub>	300		850	mV	
Output Differential Impedance	Z <sub>IN</sub>	80	100	120	Ω	

## Optical Characteristics

Parameter	Symbol	Min.	Typ.	Max.	Unit	Notes
<b>Transmitter</b>						
Optical Power (Average)	P <sub>AVE</sub>	-9.5		-3	dBm	1
Optical Extinction Ratio	ER	9			dB	
Optical Wavelength	Tλ	1270	1310	1355	nm	
Insertion Loss	IL		0.6			
<b>Receiver</b>						
Receiver Sensitivity (Average)	R <sub>AVE</sub>			-24	dBm	3
Receiver Overload	P <sub>max</sub>	0			dBm	4
Optical Return Loss	ORL	12			dB	
Receiver Wavelength	Rλ	1260		1565	nm	

### Notes:

1. Coupled into a single-mode fiber.
2. Per IEEE 802.3ah specification.
3. Average power, back-to-back, @1.25Gbps, BER 1E<sup>-12</sup>, and PRBS 2<sup>31</sup>-1.
4. Exceeding the Receiver Overload can physically damage the module. Please use appropriate attenuation.

## Pin Descriptions

Pin	Symbol	Name/Description	Notes
1	VeeT	Transmitter Ground (Common with Receiver Ground).	1
2	Tx_Fault	Transmitter Fault. Not Supported.	
3	Tx_Disable	Transmitter Disable. Laser output disabled on “high” or “open.”	2
4	MOD_DEF (2)	Module Definition 2. Data Line for Serial ID.	3
5	MOD_DEF (1)	Module Definition 1. Clock Line for Serial ID.	3
6	MOD_DEF (0)	Module Definition 0. Grounded within the module.	3
7	Rate Select	No Connection Required.	
8	LOS	Loss of Signal Indication. “Logic 0” indicates normal operation.	4
9	VeeR	Receiver Ground (Common with Transmitter Ground).	1
10	VeeR	Receiver Ground (Common with Transmitter Ground).	1
11	VeeR	Receiver Ground (Common with Transmitter Ground).	1
12	RD-	Receiver Inverted Data Out. AC Coupled.	
13	RD+	Receiver Non-Inverted Data Out. AC Coupled.	
14	VeeR	Receiver Ground (Common with Transmitter Ground).	1
15	VccR	Receiver Power Supply.	
16	VccT	Transmitter Power Supply.	
17	VeeT	Transmitter Ground (Common with Receiver Ground).	1
18	TD+	Transmitter Non-Inverted Data In. AC Coupled.	
19	TD-	Transmitter Inverted Data In. AC Coupled.	
20	VeeT	Transmitter Ground (Common with Receiver Ground).	1

### Notes:

1. The circuit ground is isolated from the chassis ground.
2. Disabled:  $T_{DIS} > 2V$  or Open, Enabled:  $T_{DIS} < 0.8V$ .
3. Should be pulled up with  $4.7k\Omega$  to  $10k\Omega$  on the host board to a voltage between 2V and 3.6V.
4. LOS is an open collector output.



Pin-Out of Connector Block on the Host Board

### Recommended Circuit Schematic

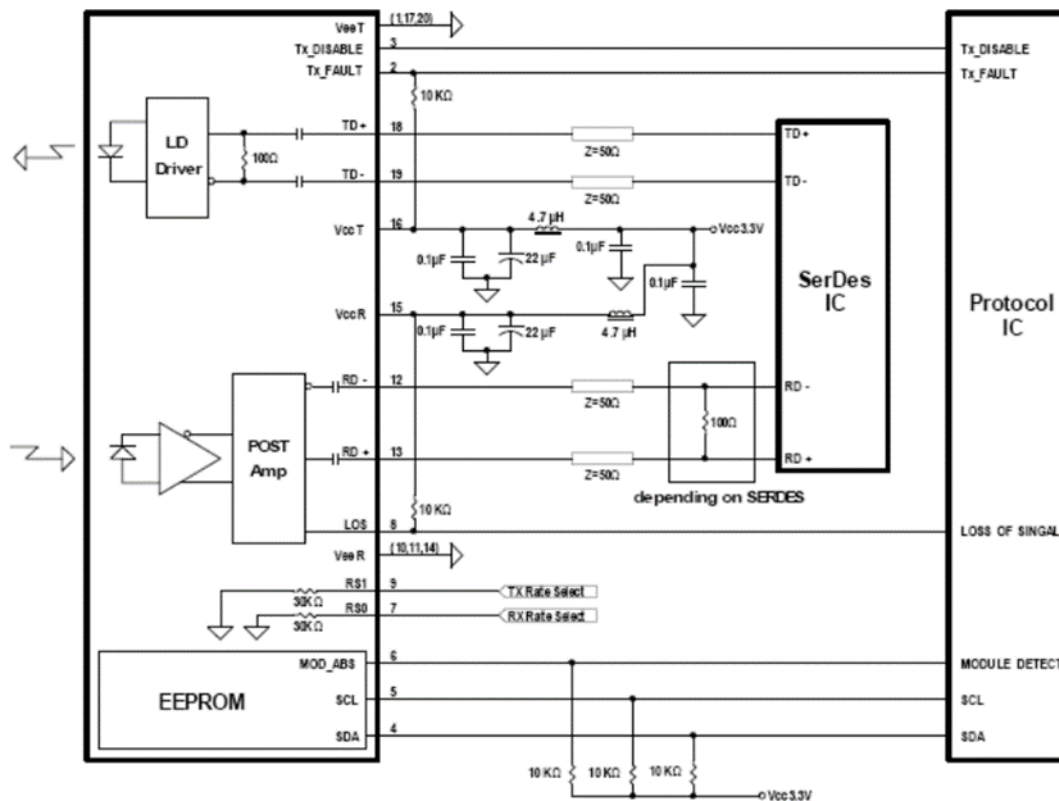

### Mechanical Specifications

Small Form Factor Pluggable (SFP) transceivers are compatible with the dimensions defined by the SFP Multi-Sourcing Agreement (MSA).



### EEPROM Information

EEPROM memory map-specific data field description is as below:

2 wire address 1010000X (A0h)		2 wire address 1010001X (A2h)	
0	Serial ID Defined by SFP MSA (96 bytes)	0	Alarm and Warning Thresholds (56 bytes)
95		55	Cal Constants (40 bytes)
	Vendor Specific (32 bytes)	95	Real Time Diagnostic Interface (24 bytes)
127		119	Vendor Specific (8 bytes)
	Reserved, SFF8079 (128 bytes)	127	User Writable EEPROM (120 bytes)
		247	
255		255	Vendor Specific (8 bytes)

## About ProLabs

Our experience comes as standard; for over 15 years ProLabs has delivered optical connectivity solutions that give our customers freedom and choice through our ability to provide seamless interoperability. At the heart of our company is the ability to provide state-of-the-art optical transport and connectivity solutions that are compatible with over 90 optical switching and transport platforms.

## Complete Portfolio of Network Solutions

ProLabs is focused on innovations in optical transport and connectivity. The combination of our knowledge of optics and networking equipment enables ProLabs to be your single source for optical transport and connectivity solutions from 100Mb to 400G while providing innovative solutions that increase network efficiency. We provide the optical connectivity expertise that is compatible with and enhances your switching and transport equipment.

## Trusted Partner

Customer service is our number one value. ProLabs has invested in people, labs and manufacturing capacity to ensure that you get immediate answers to your questions and compatible product when needed. With Engineering and Manufacturing offices in the U.K. and U.S. augmented by field offices throughout the U.S., U.K. and Asia, ProLabs is able to be our customers best advocate 24 hours a day.



## Contact Information

ProLabs US

Email: [sales@prolabs.com](mailto:sales@prolabs.com)

Telephone: 952-852-0252

ProLabs UK

Email: [salessupport@prolabs.com](mailto:salessupport@prolabs.com)

Telephone: +44 1285 719 600