

## SFP-25GB-DW53-10-C

MSA and TAA 25GBase-DWDM SFP28 Transceiver C-Band 100GHz (SMF, 1535.04nm, 10km, LC, DOM)

### Features:

- SFF-8432 and SFF-8472 Compliance
- Duplex LC Connector
- Single-mode Fiber
- Commercial Temperature 0 to 70 Celsius
- Hot Pluggable
- Metal with Lower EMI
- Excellent ESD Protection
- RoHS Compliant and Lead Free



### Applications:

- 25GBase-LR Ethernet
- Access, Metro and Enterprise

### Product Description

This MSA compliant SFP28 transceiver provides 25GBase-DWDM throughput up to 10km over single-mode fiber (SMF) using a wavelength of 1535.04nm via an LC connector. It can operate at temperatures between 0 and 70C. All of our transceivers are built to comply with Multi-Source Agreement (MSA) standards and are uniquely serialized and tested for data-traffic and application to ensure seamless network integration. Additional product features include Digital Optical Monitoring (DOM) support which allows access to real-time operating parameters. This transceiver is Trade Agreements Act (TAA) compliant. We stand behind the quality of our products and proudly offer a limited lifetime warranty.

ProLabs' transceivers are RoHS compliant and lead-free.

TAA refers to the Trade Agreements Act (19 U.S.C. & 2501-2581), which is intended to foster fair and open international trade. TAA requires that the U.S. Government may acquire only "U.S.-made or designated country end products."



## Regulatory Compliance

- ESD to the Electrical PINs: compatible with MIL-STD-883E Method 3015.4
- ESD to the LC Receptacle: compatible with IEC 61000-4-3
- EMI/EMC compatible with FCC Part 15 Subpart B Rules, EN55022:2010
- Laser Eye Safety compatible with FDA 21CFR, EN60950-1& EN (IEC) 60825-1,2
- RoHS compliant with EU RoHS 2.0 directive 2015/863/EU

## Wavelength Guide (100GHz ITU Channels)

Channel	Wavelength (nm)	Frequency (THZ)	Channel	Wavelength (nm)	Frequency (THZ)
21	1560.61	192.1	41	1544.53	194.1
22	1559.79	192.2	42	1543.73	194.2
23	1558.98	192.3	43	1542.94	194.3
24	1558.17	192.4	44	1542.14	194.4
25	1557.36	192.5	45	1541.35	194.5
26	1556.55	192.6	46	1540.56	194.6
27	1555.75	192.7	47	1539.77	194.7
28	1554.94	192.8	48	1538.98	194.8
29	1554.13	192.9	49	1538.19	194.9
30	1553.33	193.0	50	1537.4	195.0
31	1552.52	193.1	51	1536.61	195.1
32	1551.72	193.2	52	1535.82	195.2
33	1550.92	193.3	53	1535.04	195.3
34	1550.12	193.4	54	1534.25	195.4
35	1549.32	193.5	55	1533.47	195.5
36	1548.51	193.6	56	1532.68	195.6
37	1547.72	193.7	57	1531.9	195.7
38	1546.92	193.8	58	1531.12	195.8
39	1546.12	193.9	59	1530.33	195.9
40	1545.32	194.0	60	1529.55	196.0

## Absolute Maximum Ratings

Parameter	Symbol	Min.	Typ.	Max.	Unit	Notes
Maximum Supply Voltage	Vcc	-0.3		4.0	V	
Storage Temperature	TS	-40		85	°C	
Operating Case Temperature	Tc	0		70	°C	
Relative Humidity	RH	0		85	%	
Data Rate	BR	24.33		25.78	Gbps	

## Electrical Characteristics

Parameter	Symbol	Min.	Typ.	Max.	Unit	Notes
Supply Voltage	V <sub>CC</sub>	3.13		3.47		
Power Dissipation	PD			2.0	W	
<b>Transmitter</b>						
Data Input Swing Differential	V <sub>IN</sub>	190		1000	mV	
Differential line input Impedance	R <sub>IN</sub>	80	100	120	Ohm	
Transmitter Fault Output-High	V <sub>FaultH</sub>	2		V <sub>CC</sub> +0.3	V	
Transmitter Fault Output-Low	V <sub>FaultL</sub>	VEE		VEE +0.8	V	
Transmitter Disable Voltage-High	V <sub>DisH</sub>	2		V <sub>CC</sub> +0.3	V	
Transmitter Disable Voltage- low	V <sub>DisL</sub>	VEE		VEE +0.8	V	
<b>Receiver</b>						
Differential line Output Impedance	R <sub>OUT</sub>	80	100	120	Ohm	
Differential Data Output Voltage	V <sub>DR</sub>	350		850	mVp-p	
LOS Output Voltage-High	V <sub>LOSH</sub>	2		V <sub>CC</sub> +0.3	V	
LOS Output Voltage-Low	V <sub>LOSL</sub>	VEE		VEE +0.8	V	
<b>Others</b>						
Cold-Start time	T <sub>start-cooled</sub>			35	s	

## Optical Characteristics

Parameter	Symbol	Min.	Typ.	Max.	Unit	Notes
<b>Transmitter</b>						
Wavelength	$\lambda$	1529.55		1560.61	nm	
Center Wavelength Spacing		100			GHz	
Average Launched Power	P <sub>O</sub>	-1		5	dBm	
Extinction Ratio	ER	6			dB	
Average Launched Power (Laser Off)	P <sub>off</sub>			-30	dBm	
Side-Mode Suppression Ratio	SMSR	30			dB	
Relative Intensity Noise	RIN <sub>20</sub> OMA			-130	dB/Hz	
<b>Receiver</b>						
Center Wavelength	$\lambda_{IN}$	1260		1620	nm	
Receiver Overload	P <sub>overload</sub>	2			dBm	
Receiver Sensitivity @5E-5 BOL	P <sub>sen</sub> BOL			-15	dBm	
Receiver Sensitivity @5E-5 EOL	P <sub>sen</sub> EOL			-14.5	dBm	1
Receiver Sensitivity @5E-5 EOL after 10km fiber transmission	P <sub>sen1</sub> EOL			-9.0	dBm	1
Los Of Signal Assert	PA	-30			dBm	
Los Of Signal De-assert	PD			-16	dBm	
LOS -Hysteresis	P <sub>Hys</sub>	0.5		6	dB	

### Notes:

1. Measured at 5E-5, ER>4dB, PRBS 2<sup>31</sup> -1

## Pin Descriptions

Pin	Symbol	Name/Descriptions	Ref.
1	VEET	Transmitter Ground	1
2	TFAULT	Transmitter Fault	2
3	TDIS	Transmitter Disable. Laser output disabled on high or open.	3
4	SDA	2-wire Serial Interface Data Line	2
5	SCL	2-wire Serial Interface Clock Line	2
6	MOD_ABS	Module Absent. Grounded within the module	2
7	NA	Not Used	
8	RX_LOS	Loss of Signal indication. Logic 0 indicates normal operation.	4
9	NA	No Used	
10	VEER	Receiver Ground	1
11	VEER	Receiver Ground	1
12	RD-	Receiver Inverted DATA out. AC Coupled.	
13	RD+	Receiver Non-inverted DATA out. AC Coupled.	
14	VEER	Receiver Ground	1
15	VCCR	Receiver Power Supply	5
16	VCCT	Transmitter Power Supply	5
17	VEET	Transmitter Ground	1
18	TD+	Transmitter Non-Inverted DATA in. AC Coupled.	
19	TD-	Transmitter Inverted DATA in. AC Coupled.	
20	VEET	Transmitter Ground	1

### Notes:

1. Circuit ground is internally isolated from chassis ground.
2. T<sub>FAULT</sub> is an open collector/drain output, which should be pulled up with a 4.7k – 10k Ohms resistor on the host board if intended for use. Pull up voltage should be between 2.0V to V<sub>cc</sub> + 0.3V. A high output indicates a transmitter fault caused by either the TX bias current or the TX output power exceeding the preset alarm thresholds. A low output indicates normal operation. In the low state, the output is pulled to <0.8V.
3. Laser output disabled on T<sub>DIS</sub> >2.0V or open, enabled on T<sub>DIS</sub> <0.8V.
4. LOS is open collector output. Should be pulled up with 4.7k – 10kΩ on host board to a voltage between 2.0V and 3.6V. Logic 0 indicates normal operation; logic 1 indicates loss of signal.
5. Internally connected

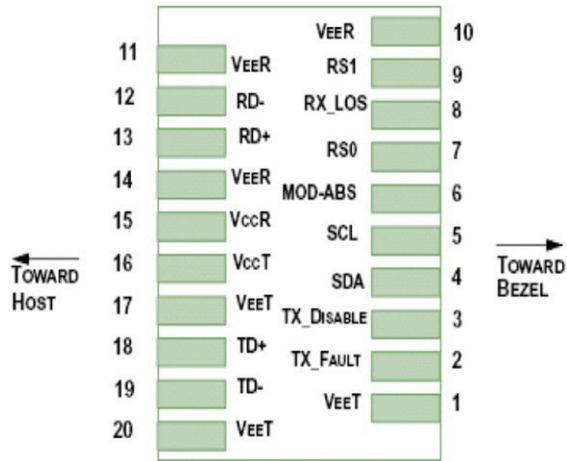

Pin-out of connector Block on Host board

### Block Diagram of Transceiver

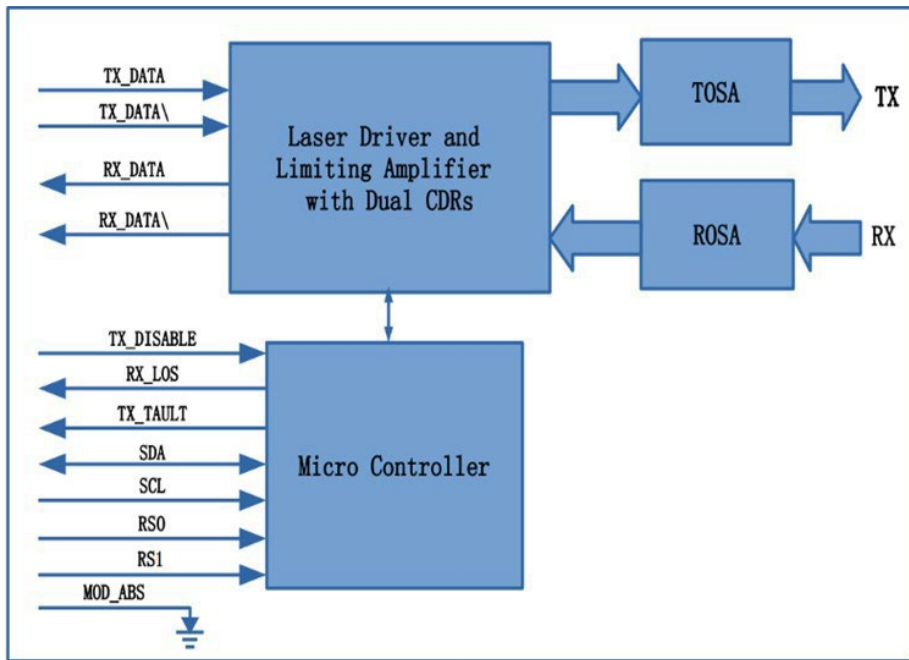

## Recommended Interface Circuit



## Mechanical Specifications



## About ProLabs

Our extensive experience comes as standard. For over 20 years ProLabs has delivered optical connectivity solutions that give our customers freedom and choice through our ability to provide seamless interoperability. At the heart of our company is the ability to provide state-of-the-art optical transport and connectivity solutions that are compatible with more than 100 optical switching and transport platforms.

## A Complete Portfolio of Network Solutions

ProLabs is focused on innovations in optical transport and connectivity. The combination of our knowledge of optics and networking equipment enables ProLabs to be your single source for optical transport and connectivity solutions from 100Mb to 1.6T while providing innovative solutions that increase network efficiency. We provide the optical connectivity expertise that is compatible with and enhances your switching and transport equipment.

## The Trusted Partner

Customer service is our number one value. ProLabs has invested in people, labs and manufacturing capacity to ensure compatible products, and immediate answers to your questions. With Engineering and Manufacturing offices in the U.K. and U.S. augmented by field offices throughout the U.S., U.K. and Asia, ProLabs is able to be our customers best advocate 24 hours a day.



## Contact Information

ProLabs US

Email: [sales@prolabs.com](mailto:sales@prolabs.com)

Telephone: 952-852-0252

ProLabs UK

Email: [salessupport@prolabs.com](mailto:salessupport@prolabs.com)

Telephone: +44 1285 719 600