

OSFP-2XQ112-800GB-PDAC3M-C

MSA and TAA 800GBase-CU OSFP to 2xQSFP112 Direct Attach Cable (Passive Twinax, 3m)

Features:

- OSFP Module Compliant to MSA Standards
- QSFP112 Module Compliant to MSA Standards
- Transmission Data Rate Up to PAM4 106.25Gbps Per Channel
- Enable 800Gbps to 2x400Gbps Transmission
- Built-In EEPROM Functions with Write Protection
- Operating Temperature Range: 0 to 70 Celsius
- RoHS Compliant and Lead-Free



Applications:

- 800GBase Ethernet

Product Description

This MSA compliant 800GBase-CU OSFP to 2xQSFP112 direct attach cable operates over passive copper with a maximum reach of 3.0m (9.8ft). It has been programmed, uniquely serialized, and data-traffic and application tested to ensure it is 100% compliant and functional. This direct attach cable is TAA (Trade Agreements Act) compliant, and is built to comply with MSA (Multi-Source Agreement) standards. We stand behind the quality of our products and proudly offer a limited lifetime warranty.

ProLabs' transceivers are RoHS compliant and lead-free.

TAA refers to the Trade Agreements Act (19 U.S.C. & 2501-2581), which is intended to foster fair and open international trade. TAA requires that the U.S. Government may acquire only "U.S.-made or designated country end products.")



General Specifications

Parameter	Symbol	Min.	Typ.	Max.	Unit
Storage Temperature	Tstg	-40		85	°C
Operating Case Temperature	Tc	0		70	°C
Supply Voltage	Vcc	3.13	3.3	3.47	V
Relative Operating Humidity	RH	5		85	%
Data Rate	DR		800		Gbps

Physical Characteristics

Parameter	Symbol	Min.	Typ.	Max.	Unit	Notes
Length	L			3	M	
AWG			25		AWG	
Jacket Material		Plastic Braided Mesh Technology Net, Silver Gray				

Electrical Specifications

Parameter	Symbol	Min.	Typ.	Max.	Unit	Notes
Resistance	Rcon			3	Ω	
Insulation Resistance	Rins			10	MΩ	
Raw Cable Impedance	Zca	95		110	Ω	
Mated Connector Impedance	Zmated	85		115	Ω	
Maximum Insertion Loss @26.56GHz	SDD21	11		25.3	dB	
Differential- to Common-Mode Return Loss	SDD11/22	$RL_{cd}(f) \geq \begin{cases} 22 - 10(f/26.56) & 0.05 \leq f < 26.56 \\ 15 - 3(f/26.56) & 26.56 \leq f \leq 40 \end{cases}$			dB	1
Differential- to Common-Mode Conversion Loss	SCD21-SDD21	$Conversion_loss(f) - \begin{cases} 10 & 0.05 \leq f < 12.89 \\ 14 - 0.3108f & 12.89 \leq f \leq 40 \end{cases}$			dB	1
Common-Mode to Common-Mode Return Loss	SCC11-22	$RL_{cc}(f) \geq 1.08$			dB	1
Minimum COM	COM	3			dB	

Notes:

1. For $0.05 \leq f \leq 40$ GHz, where f is the frequency in GHz.

Pin Descriptions for OSFP

Pin	Symbol	Name/Description	Logic	Plug Sequence	Direction	Notes
1	GND	Module Ground.		1		
2	Tx2+	Transmitter Data Non-Inverted.	CML-I	3	Input from Host	
3	Tx2-	Transmitter Data Inverted.	CML-I	3	Input from Host	
4	GND	Module Ground.		1		
5	Tx4+	Transmitter Data Non-Inverted.	CML-I	3	Input from Host	
6	Tx4-	Transmitter Data Inverted.	CML-I	3	Input from Host	
7	GND	Module Ground.		1		
8	Tx6+	Transmitter Data Non-Inverted.	CML-I	3	Input from Host	
9	Tx6-	Transmitter Data Inverted.	CML-I	3	Input from Host	
10	GND	Module Ground.		1		
11	Tx8+	Transmitter Data Non-Inverted.	CML-I	3	Input from Host	
12	Tx8-	Transmitter Data Inverted.	CML-I	3	Input from Host	
13	GND	Module Ground.		1		
14	SCL	2-Wire Serial Interface Clock.	LVC MOS-I/O	3	Bi-Directional	1
15	Vcc	+3.3V Power.		2	Power from Host	
16	Vcc	+3.3V Power.		2	Power from Host	
17	LPWn/PRSn	Low-Power Mode/Module Present.	Multi-Level	3	Bi-Directional	2
18	GND	Module Ground.		1		
19	Rx7-	Receiver Data Inverted.	CML-O	3	Output from Host	
20	Rx7+	Receiver Data Non-Inverted.	CML-O	3	Output from Host	
21	GND	Module Ground.		1		
22	Rx5-	Receiver Data Inverted.	CML-O	3	Output from Host	
23	Rx5+	Receiver Data Non-Inverted.	CML-O	3	Output from Host	
24	GND	Module Ground.		1		
25	Rx3-	Receiver Data Inverted.	CML-O	3	Output from Host	
26	Rx3+	Receiver Data Non-Inverted.	CML-O	3	Output from Host	
27	GND	Module Ground.		1		
28	Rx1-	Receiver Data Inverted.	CML-O	3	Output from Host	
29	Rx1+	Receiver Data Non-Inverted.	CML-O	3	Output from Host	
30	GND	Module Ground.		1		
31	GND	Module Ground.		1		
32	Rx2+	Receiver Data Non-Inverted.	CML-O	3	Output from Host	
33	Rx2-	Receiver Data Inverted.	CML-O	3	Output from Host	
34	GND	Module Ground.		1		
35	Rx4+	Receiver Data Non-Inverted.	CML-O	3	Output from Host	
36	Rx4-	Receiver Data Inverted.	CML-O	3	Output from Host	
37	GND	Module Ground.		1		
38	Rx6+	Receiver Data Non-Inverted.	CML-O	3	Output from Host	
39	Rx6-	Receiver Data Inverted.	CML-O	3	Output from Host	

40	GND	Module Ground.		1		
41	Rx8+	Receiver Data Non-Inverted.	CML-O	3	Output from Host	
42	Rx8-	Receiver Data Inverted.	CML-O	3	Output from Host	
43	GND	Module Ground.		1		
44	INT/RSTn	Module Interrupt/Module Reset.	Multi-Level	3	Bi-Directional	2
45	Vcc	+3.3V Power.		2	Power from Host	
46	Vcc	+3.3V Power.		2	Power from Host	
47	SDA	2-Wire Serial Interface Data.	LVCMOS-I/O	3	Bi-Directional	1
48	GND	Module Ground.		1		
49	Tx7-	Transmitter Data Inverted.	CML-I	3	Input from Host	
50	Tx7+	Transmitter Data Non-Inverted.	CML-I	3	Input from Host	
51	GND	Module Ground.		1		
52	Tx5-	Transmitter Data Inverted.	CML-I	3	Input from Host	
53	Tx5+	Transmitter Data Non-Inverted.	CML-I	3	Input from Host	
54	GND	Module Ground.		1		
55	Tx3-	Transmitter Data Inverted.	CML-I	3	Input from Host	
56	Tx3+	Transmitter Data Non-Inverted.	CML-I	3	Input from Host	
57	GND	Module Ground.		1		
58	Tx1-	Transmitter Data Inverted.	CML-I	3	Input from Host	
59	Tx1+	Transmitter Data Non-Inverted.	CML-I	3	Input from Host	
60	GND	Module Ground.		1		

Notes:

1. Open-drain with pull-up resistor on the host.
2. See below for required circuit.

Electrical Pin-Out Details for OSFP

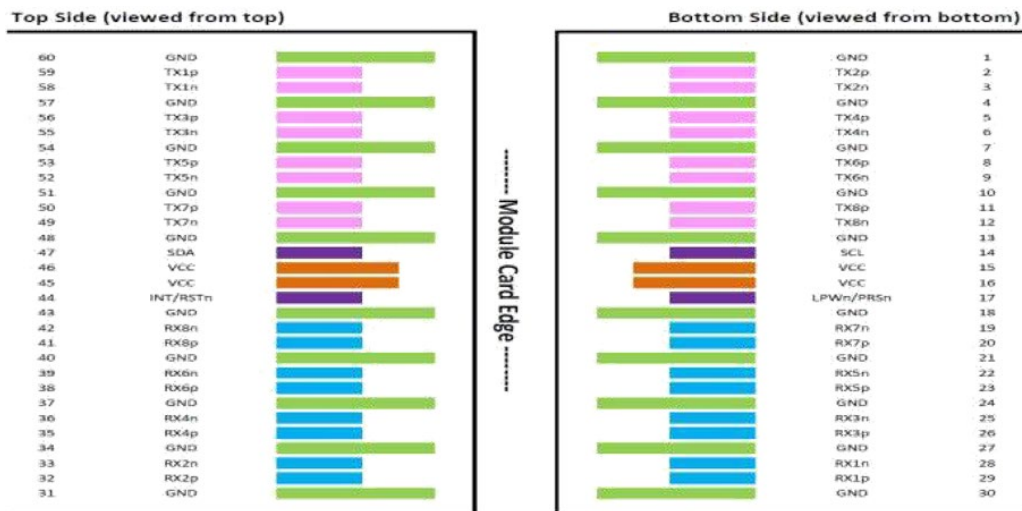

Pin Descriptions for QSFP112

Pin	Logic	Symbol	Name/Description	Plug Sequence	Notes
1		GND	Module Ground.	1	1
2	CML-I	Tx2-	Transmitter Inverted Data Input.	3	
3	CML-I	Tx2+	Transmitter Non-Inverted Data Input.	3	
4		GND	Module Ground.	1	1
5	CML-I	Tx4-	Transmitter Inverted Data Input.	3	
6	CML-I	Tx4+	Transmitter Non-Inverted Data Input.	3	
7		GND	Module Ground.	1	1
8	LVTTTL-I	ModSelL	Module Select.	3	
9	LVTTTL-I	ResetL	Module Reset.	3	
10		VccRx	+3.3V Receiver Power Supply.	2	2
11	LVC MOS-I/O	SCL	2-Wire Serial Interface Clock.	3	
12	LVC MOS-I/O	SDA	2-Wire Serial Interface Data.	3	
13		GND	Module Ground.	1	1
14	CML-O	Rx3+	Receiver Non-Inverted Data Output.	3	
15	CML-O	Rx3-	Receiver Inverted Data Output.	3	
16		GND	Module Ground.	1	1
17	CML-O	Rx1+	Receiver Non-Inverted Data Output.	3	
18	CML-O	Rx1-	Receiver Inverted Data Output.	3	
19		GND	Module Ground.	1	1
20		GND	Module Ground.	1	1
21	CML-O	Rx2-	Receiver Inverted Data Output.	3	
22	CML-O	Rx2+	Receiver Non-Inverted Data Output.	3	
23		GND	Module Ground.	1	1
24	CML-O	Rx4-	Receiver Inverted Data Output.	3	
25	CML-O	Rx4+	Receiver Non-Inverted Data Output.	3	
26		GND	Module Ground.	1	1
27	LVTTTL-O	ModPrsL	Module Present.	3	
28	LVTTTL-O	IntL	Interrupt.	3	
29		Vcc	+3.3V Transmitter Power Supply.	2	2
30		Vcc	+3.3V Power Supply.	2	2
31	LVTTTL-I	LPMODE	Low-Power Mode.	3	
32		GND	Module Ground.	1	1
33	CML-I	Tx3+	Transmitter Non-Inverted Data Input.	3	
34	CML-I	Tx3-	Transmitter Inverted Data Input.	3	

35		GND	Module Ground.	1	1
36	CML-I	Tx1+	Transmitter Non-Inverted Data Input.	3	
37	CML-I	Tx1-	Transmitter Inverted Data Input.	3	
38		GND	Module Ground.	1	1

Notes:

1. GND is the symbol for signal and supply (power) common for the QSFP+ module. All are common within the QSFP module, and all module voltages are referenced to this potential unless otherwise noted. Connect these directly to the host board signal common ground plane.
2. VccRx, Vcc1, and VccTx are the receiver and transmitter power supplies and shall be applied concurrently. VccRx, Vcc1, and VccTx may be internally connected within the QSFP transceiver module in any combination. The connector pins are each rated for a maximum current of 500mA.

Electrical Pin-Out Details for QSFP112

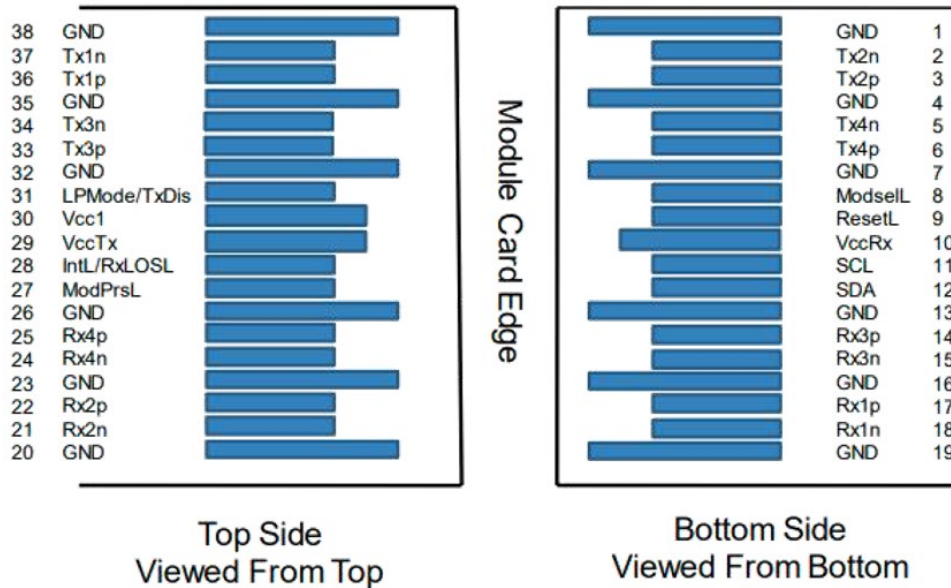

Mechanical Specifications

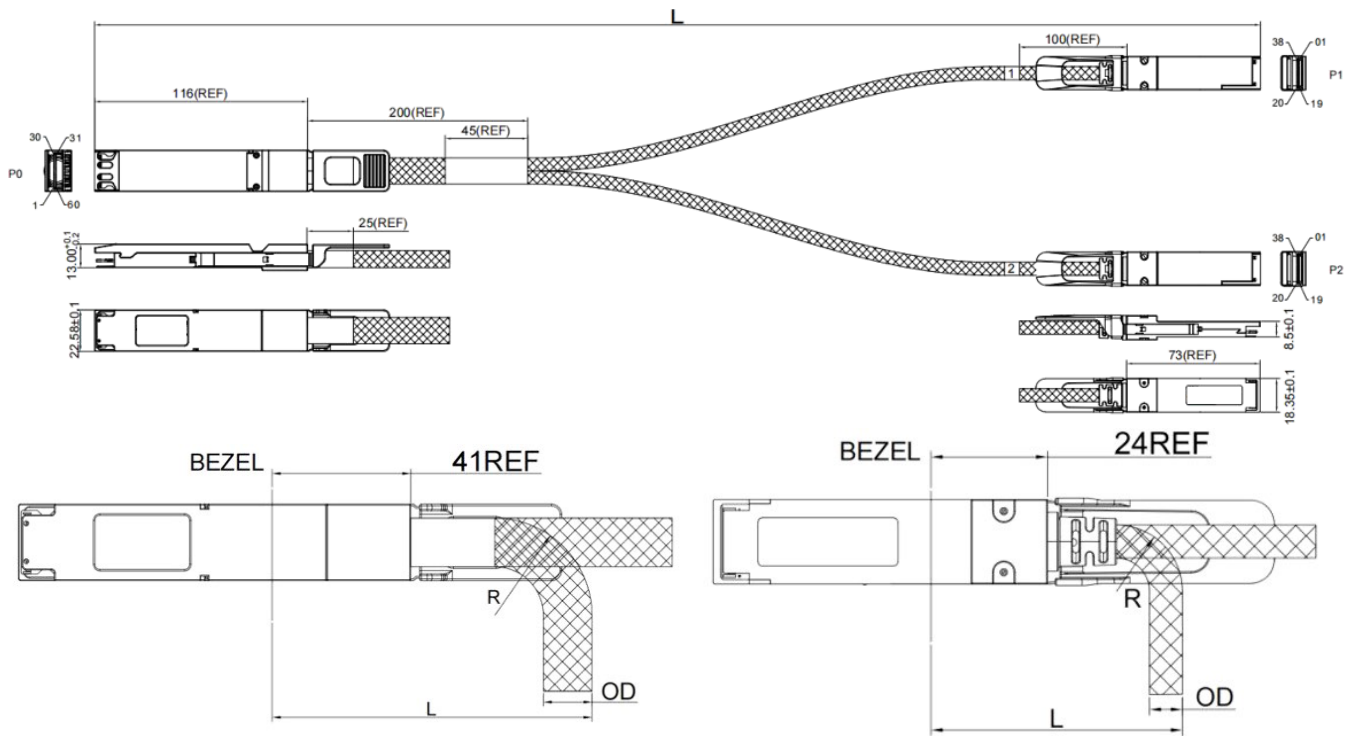

800G OSFP				QSFP112			
Gauge	OD	Bend Radius "R"	Min. Bend Radius "L"	Gauge	OD	Bend Radius "R"	Min. Bend Radius "L"
25AWG	12.1MM	25MM	70MM	25AWG	8.3MM	17MM	55MM

About ProLabs

Our extensive experience comes as standard. For over 20 years ProLabs has delivered optical connectivity solutions that give our customers freedom and choice through our ability to provide seamless interoperability. At the heart of our company is the ability to provide state-of-the-art optical transport and connectivity solutions that are compatible with more than 100 optical switching and transport platforms.

A Complete Portfolio of Network Solutions

ProLabs is focused on innovations in optical transport and connectivity. The combination of our knowledge of optics and networking equipment enables ProLabs to be your single source for optical transport and connectivity solutions from 100Mb to 1.6T while providing innovative solutions that increase network efficiency. We provide the optical connectivity expertise that is compatible with and enhances your switching and transport equipment.

The Trusted Partner

Customer service is our number one value. ProLabs has invested in people, labs and manufacturing capacity to ensure compatible products, and immediate answers to your questions. With Engineering and Manufacturing offices in the U.K. and U.S. augmented by field offices throughout the U.S., U.K. and Asia, ProLabs is able to be our customers best advocate 24 hours a day.



Contact Information

ProLabs US

Email: sales@prolabs.com

Telephone: 952-852-0252

ProLabs UK

Email: salessupport@prolabs.com

Telephone: +44 1285 719 600