

QSFP112-400GB-DR4-LPO-AO

MSA and TAA 400GBase-DR4 PAM4 QSFP112 Transceiver (SMF, 1310nm, 500m, MPO-12, DOM, CMIS 5.0) LPO

Features

- Supports 106.25Gbps Data Rate Per Channel
- CMIS 5.0
- QSFP112 MSA Compliant
- Single 3.3V Power Supply
- Type 2A Housing MPO-12 Connector
- Electrically Hot-Pluggable
- Up to 500m Reach Over SMF
- Power Dissipation: 5W, Typical 4.5W
- RoHS Compliant and Lead-Free
- Operating Temperature: 0 to 70 Celsius



Applications

- 400GBase Ethernet

Product Description

This MSA compliant QSFP112 transceiver provides 400GBase-DR4 throughput up to 500m over single-mode fiber (SMF) using a wavelength of 1310nm via an MPO connector. All of our transceivers are built to comply with Multi-Source Agreement (MSA) standards and are uniquely serialized and tested for data-traffic and application to ensure seamless network integration. Additional product features include Digital Optical Monitoring (DOM) support which allows access to real-time operating parameters. This transceiver is Trade Agreements Act (TAA) compliant. We stand behind the quality of our products and proudly offer a limited lifetime warranty.

AddOn's transceivers are RoHS compliant and lead-free.

TAA refers to the Trade Agreements Act (19 U.S.C. & 2501-2581), which is intended to foster fair and open international trade. TAA requires that the U.S. Government may acquire only "U.S.-made or designated country end products."



Absolute Maximum Ratings

Parameter	Symbol	Min.	Typ.	Max.	Unit	Notes
Storage Temperature	Tstg	-40		85	°C	
Operating Case Temperature	Tc	0		70	°C	Without air flow
Relative Humidity	RH	5		85	%	
Supply Voltage	Vcc	-0.5		3.6	V	
Data Rate	DR		53.125 ± 100ppm			@PAM4 per channel
Power Supply Voltage	Vcc	3.135	3.3	3.465	V	
Power Supply Current	Icc			1515	mA	When Vcc is 3.3V
Power Dissipation	PD		4.5	5	W	
Transmission Distance	TD			500	m	
Coupled Fiber			Single-Mode Fiber			9/125µm SMF

Optical Characteristics

Parameter	Symbol	Min.	Typ.	Max.	Unit	Notes
Transmitter						
Center Wavelength	λ_C	1304.5		1317.5	nm	1
Average Launch Power Per Lane	P	-2.9		4	dBm	
Transmit OMA Per Lane		-0.8		4.2	dBm	
Transmitter and Dispersion Eye Closure for PAM4 TDECQ Per Lane	TDECQ			3.4	dB	
Side-Mode Suppression Ratio	SMSR	30			dB	
Optical Extinction Ratio	ER	3.5			dB	
Average Launch Power of Off Per Lane	Poff			-15	dBm	
RIN _{17,1} OMA	RIN			-136	dB/Hz	
Transmitter Reflectance	TR			-26	dBm	
Receiver						
Lane Wavelength	λ	1304.5		1317.5	nm	1
Damage Threshold Per Lane		5			dBm	2
Receive Power (OMA) Per Lane	ROMA			4.2	dBm	
Average Input Power Per Channel	RxPx	-5.9		4.0	dBm	
Receiver Sensitivity (OMA) Per Lane	PxSens			-4.4	dBm	3
Receiver Reflectance	RR			-26	dB	

Notes:

1. The wavelength assignment is suitable for all channels.
2. Measured wavelength with a PRBS31Q test pattern, BER@ 2.4×10^{-4} .
3. The receiver shall be able to tolerate, without damage, continuous exposure to an optical input signal having this average power level.

Pin Descriptions

Pin	Symbol	Name/Description	Notes
1	GND	Module Ground.	1
2	Tx2-	Transmitter Inverted Data Input.	
3	Tx2+	Transmitter Non-Inverted Data Input.	
4	GND	Module Ground.	1
5	Tx4-	Transmitter Inverted Data Input.	
6	Tx4+	Transmitter Non-Inverted Data Input.	
7	GND	Module Ground.	1
8	ModSelL	Module Select.	
9	ResetL	Module Reset.	
10	VccRx	+3.3V Receiver Power Supply.	2
11	SCL	2-Wire Serial Interface Clock.	
12	SDA	2-Wire Serial Interface Data.	
13	GND	Module Ground.	1
14	Rx3+	Receiver Non-Inverted Data Output.	
15	Rx3-	Receiver Inverted Data Output.	
16	GND	Module Ground.	1
17	Rx1+	Receiver Non-Inverted Data Output.	
18	Rx1-	Receiver Inverted Data Output.	
19	GND	Module Ground.	1
20	GND	Module Ground.	1
21	Rx2-	Receiver Inverted Data Output.	
22	Rx2+	Receiver Non-Inverted Data Output.	
23	GND	Module Ground.	1
24	Rx4-	Receiver Inverted Data Output.	
25	Rx4+	Receiver Non-Inverted Data Output.	
26	GND	Module Ground.	1
27	ModPrsL	Module Present.	
28	IntL/RxLOS	Interrupt/Optional RxLOS.	
29	VccTx	+3.3V Transmitter Power Supply.	2
30	Vcc1	+3.3V Power Supply.	2
31	LPMoDe/TxDis	Low-Power Mode/ Optional Tx Disable.	
32	GND	Module Ground.	1
33	Tx3+	Transmitter Non-Inverted Data Input.	
34	Tx3-	Transmitter Inverted Data Input.	
35	GND	Module Ground.	1

36	Tx1+	Transmitter Non-Inverted Data Input.	
37	Tx1-	Transmitter Inverted Data Input.	
38	GND	Module Ground.	1

Notes:

1. QSFP112 uses common ground (GND) for all signals and supply (power). All are common within the QSFP112 module, and all module voltages are referenced to this potential unless otherwise noted. Connect these directly to the host board signal-common ground plane.
2. VccRx, Vcc1, and VccTx are the receiver and transmitter power supplies and shall be applied concurrently. VccRx, Vcc1, and VccTx may be internally connected within the QSFP112 module in any combination. The connector pins are each rated for a maximum current of 1.5A.

Pin Assignment

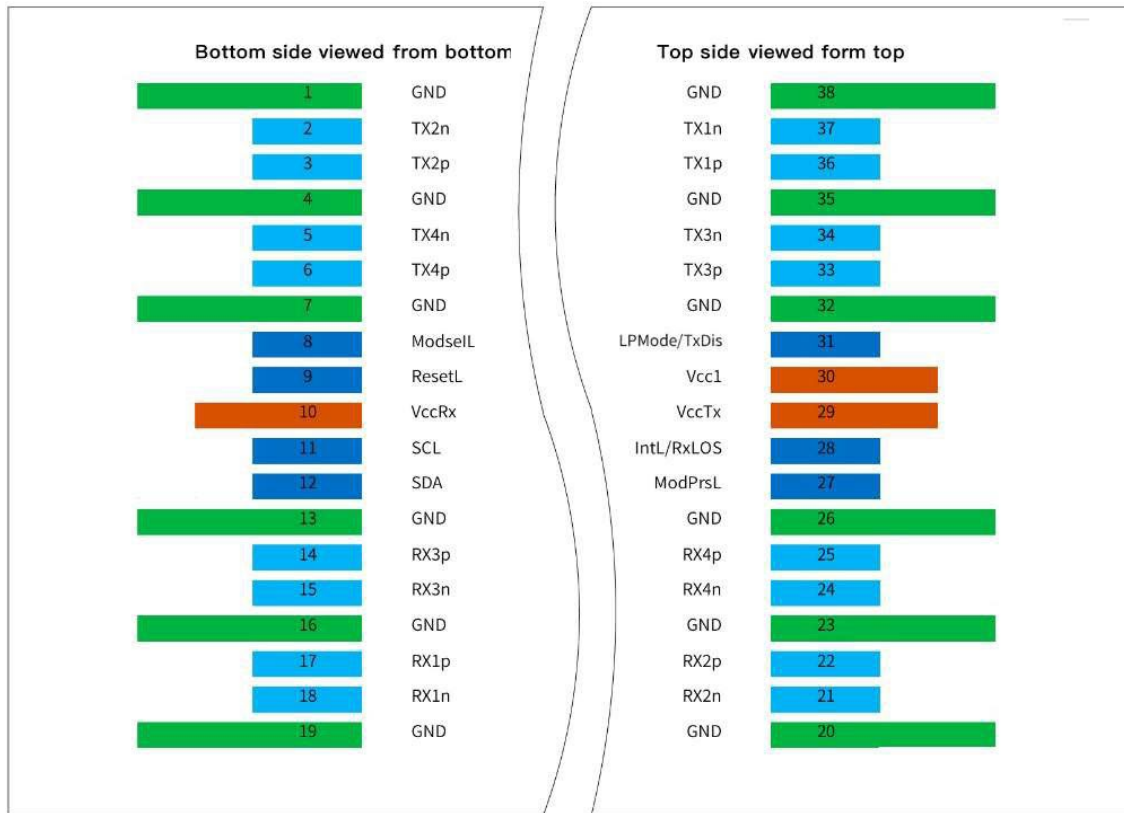

Recommended Host Board Power Supply Filter Network

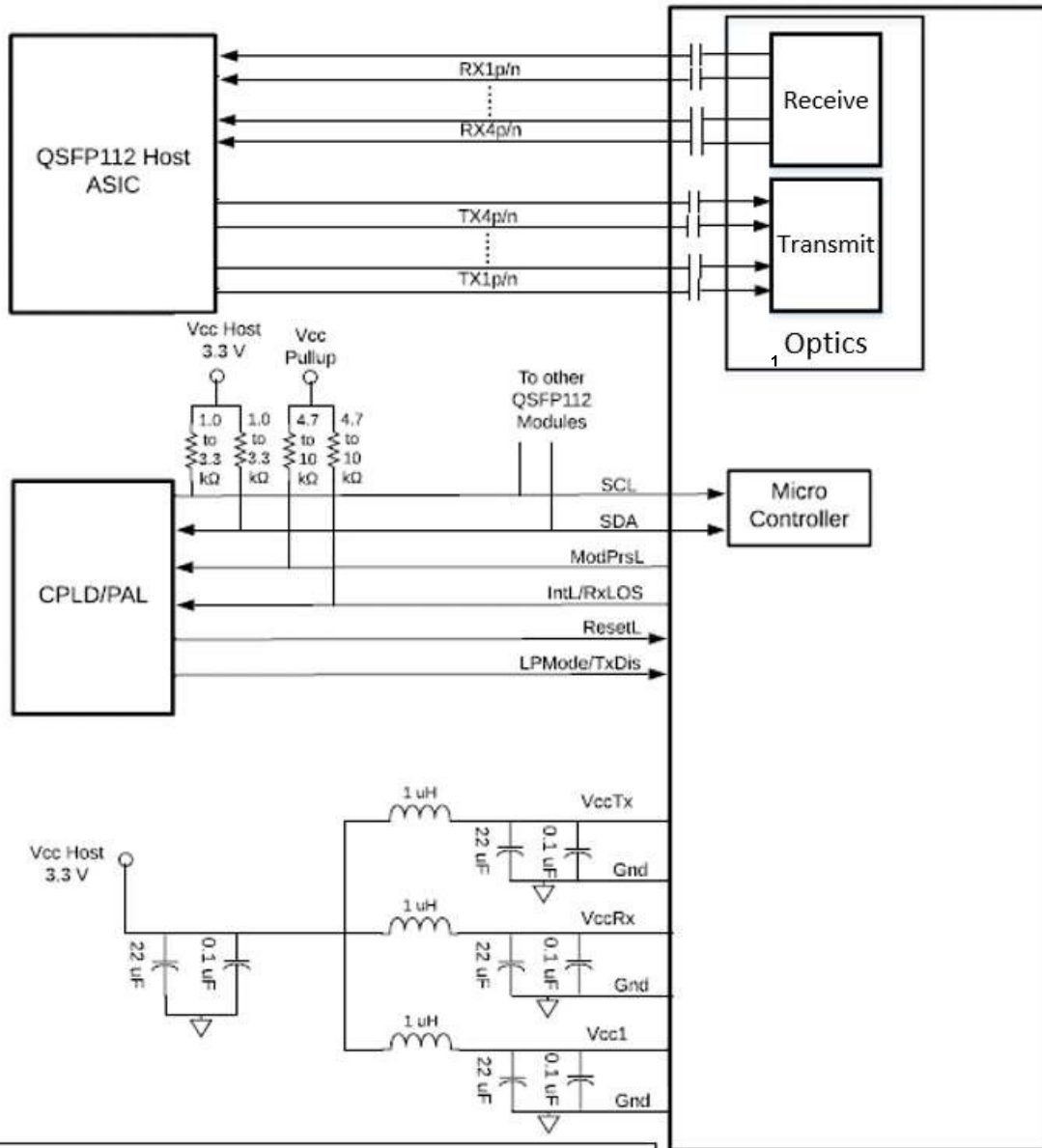

QSFP112 Optical Module

Note: Filter capacitors values are informative and application dependent, 0.1 μF capacitors should be placed in close proximity to power pads and may be duplicated for individual pads to provide additional high frequency filtering.

Note: Vcc1 may be connected to VccTx or VccRx within the module provided the applicable derating of the maximum current limit is used.

Mechanical Specifications

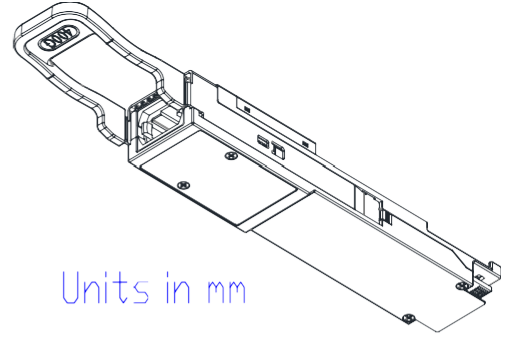
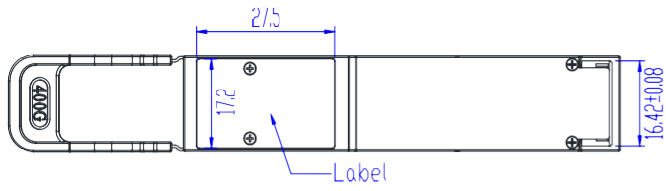

Units in mm

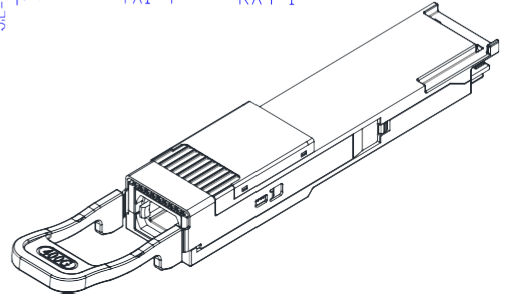
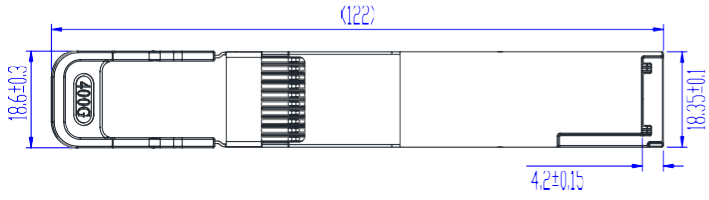
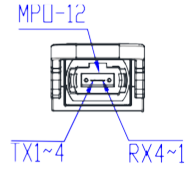
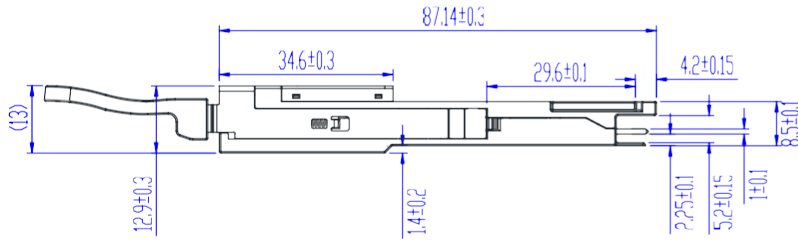

About AddOn Networks

In 1999, AddOn Networks entered the market with a single product. Our founders fulfilled a severe shortage for compatible, cost-effective optical transceivers that compete at the same performance levels as leading OEM manufacturers. Adhering to the idea of redefining service and product quality not previously had in the fiber optic networking industry, AddOn invested resources in solution design, production, fulfillment, and global support.

Combining one of the most extensive and stringent testing processes in the industry, an exceptional free tech support center, and a consistent roll-out of innovative technologies, AddOn has continually set industry standards of quality and reliability throughout its history.

Reliability is the cornerstone of any optical fiber network and is ingrained in AddOn's DNA. It has played a key role in nurturing the long-term relationships developed over the years with customers. AddOn remains committed to exceeding industry standards with certifications ranging from NEBS Level 3 to ISO 9001:2015 with every new development while maintaining the signature reliability of its products.



U.S. Headquarters

Email: sales@addonnetworks.com

Telephone: +1 877.292.1701

Fax: 949.266.9273

Europe Headquarters

Email: salesemea@addonnetworks.com

Telephone: +44 1285 842070