

C-ATTN-SCPC-5DB

2-Pack of 5dB fixed SC Male to SC Female OS1 SMF Simplex Fiber Attenuators

Features

- SC Male to SC Female Connectors
- OS1 SMF Attenuator

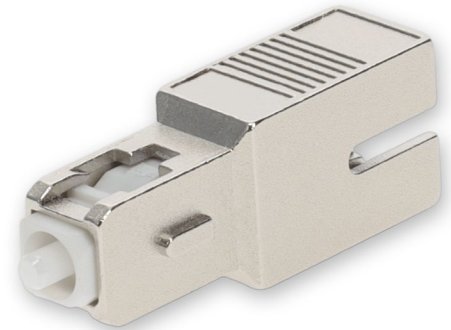

Product Description

This is a simplex SMF OS1 fiber optic attenuator, used in fiber optic links to reduce or attenuate optical power. This fixed value attenuator will reduce optical power by 5dB. It uses male to female SC connection and is used in single-mode (SMF) applications. This attenuator comes as a 2-pack. Our attenuators are cost effective and 100% compliant for all of your networking needs. Our products are guaranteed by federal law to not affect or void OEM warranties.

Specifications

Parameter	Specifications
Connector 1	SC
Connector 1 Gender	Male
Connector 2	SC
Connector 2 Gender	Female
Cable Mode	Simplex
Media	SMF
Shielded	Not Shielded
Standard	OS1
Return Loss	RL= -50dB (UPC)
Operating Temperature	-40°C to 75°C
Attenuation Tolerance	
1 to 9dB	±0.5
10 to 15dB	±1.0
16 to 20dB	±1.5

Mechanical Specifications

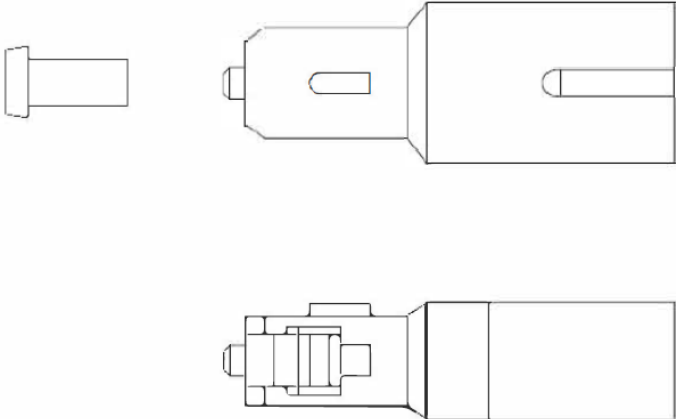
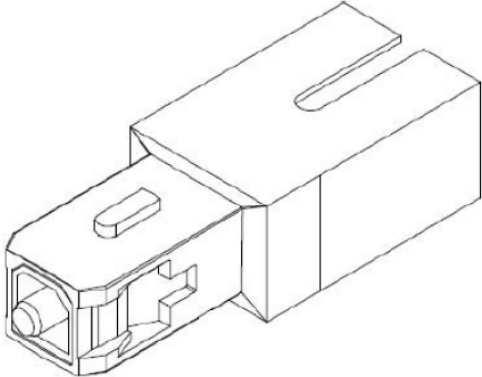

About ProLabs

Our experience comes as standard; for over 15 years ProLabs has delivered optical connectivity solutions that give our customers freedom and choice through our ability to provide seamless interoperability. At the heart of our company is the ability to provide state-of-the-art optical transport and connectivity solutions that are compatible with over 90 optical switching and transport platforms.

Complete Portfolio of Network Solutions

ProLabs is focused on innovations in optical transport and connectivity. The combination of our knowledge of optics and networking equipment enables ProLabs to be your single source for optical transport and connectivity solutions from 100Mb to 400G while providing innovative solutions that increase network efficiency. We provide the optical connectivity expertise that is compatible with and enhances your switching and transport equipment.

Trusted Partner

Customer service is our number one value. ProLabs has invested in people, labs and manufacturing capacity to ensure that you get immediate answers to your questions and compatible product when needed. With Engineering and Manufacturing offices in the U.K. and U.S. augmented by field offices throughout the U.S., U.K. and Asia, ProLabs is able to be our customers best advocate 24 hours a day.



Contact Information

ProLabs US

Email: sales@prolabs.com

Telephone: 952-852-0252

ProLabs UK

Email: salessupport@prolabs.com

Telephone: +44 1285 719 600