

SFP-1GB-CW-49-160-C

MSA and TAA 1000Base-CWDM SFP Transceiver (SMF, 1490nm, 160km, LC, DOM)

Features:

- INF-8074 and SFF-8472 Compliance
- Duplex LC Connector
- Single-mode Fiber
- Commercial Temperature 0 to 70 Celsius
- Hot Pluggable
- Metal with Lower EMI
- Excellent ESD Protection
- RoHS Compliant and Lead Free



Applications:

- Gigabit Ethernet over CWDM
- 1x Fibre Channel
- Access, Metro and Enterprise

Product Description

This MSA compliant SFP transceiver provides 1000Base-CWDM throughput up to 160km over single-mode fiber (SMF) using a wavelength of 1490nm via an LC connector. It can operate at temperatures between 0 and 70C. The listed reach has been determined using a link budget calculation and tested in a standard environment. Actual link distances achieved will be dependent upon the deployed environment. All of our transceivers are built to comply with Multi-Source Agreement (MSA) standards and are uniquely serialized and tested for data-traffic and application to ensure seamless network integration. Additional product features include Digital Optical Monitoring (DOM) support which allows access to real-time operating parameters. This transceiver is Trade Agreements Act (TAA) compliant. We stand behind the quality of our products and proudly offer a limited lifetime warranty.

ProLabs' transceivers are RoHS compliant and lead-free.

TAA refers to the Trade Agreements Act (19 U.S.C. & 2501-2581), which is intended to foster fair and open international trade. TAA requires that the U.S. Government may acquire only "U.S.-made or designated country end products.")



Absolute Maximum Ratings

Parameter	Symbol	Min.	Typ.	Max.	Unit	Notes
Data Rate	DR	0.622		1.25	Gbps	
Bit Error Rate	BER			10 ⁻¹²		
Operating Case Temperature	Tc	0		70	C	1, 4
Storage Temperature	Tstg	-40		85	C	2
Supply Current	Icc		200	300	mA	3
Maximum Voltage	VMAX	-0.5		4	V	3

Notes:

1. Case temperature.
2. Ambient temperature.
3. For the electrical power interface.
4. Commercial temperature.

Electrical Characteristics

Parameter	Symbol	Min.	Typ.	Max.	Unit	Notes
Input Voltage	Vcc	3.14	3.3	3.46	V	
Supply Current	Icc		200	300	mA	3
Transmitter						
Input Differential Impedance	RIN		100		Ω	
Single-Ended Data Input Swing	VIN,pp	250		1200	mV	
Transmit Disable Voltage	VD	Vcc-1.3		Vcc	V	
Transmit Enable Voltage	VEN	Vee		Vee+0.8	V	
Transmit Disable Assert Time				10	us	
Receiver						
Single-Ended Data Output Swing	VOUT,pp	300	400	800	mV	
Data Output Rise/Fall Time	Tr/Tf		100	175	ps	
LOS Asserted	VLOSA	Vcc-0.5		Host_Vcc	V	
LOS De-Asserted	VLOSD	Vee		Vee+0.5	V	

Optical Characteristics

Parameter	Symbol	Min.	Typ.	Max.	Unit	Notes
Transmitter						
Output Optical Power	PTX	3		7	dBm	1
Optical Center Wavelength	λ_C	1485	1491	1497	nm	
Extinction Ratio	ER	9			dB	
Side-Mode Suppression Ratio	SMSR	30			dB	
Spectral Width (-20dB)	$\Delta\lambda$			1	nm	
Optical Rise/Fall Time (20-80%)	T_r/T_f			180	ps	
Relative Intensity Noise	RIN			-120	dB/Hz	
Transmitter Jitter (Pk-Pk)	TJ			100	ps	
Output Eye	Compliant with IEEE 802.3					
Receiver						
Optical Input Wavelength	λ_C	1270		1620	nm	
Receiver Sensitivity	Rx_SEN			-34	dBm	2
Receiver Overload	POL	-7			dBm	
LOS Assert	LOSA	-42			dBm	
LOS De-Assert	LOSD			-34	dBm	
LOS Hysteresis	LOSH	0.5			dB	

Notes:

1. Average launch power.
2. Measured with a 2^7-1 test pattern over 120km @1.25Gbps with $BER < 10^{-12}$.

Pin Descriptions

Pin	Symbol	Name/Description	Notes
1	VeeT	Transmitter Ground (Common with Receiver Ground).	1
2	Tx_Fault	Transmitter Fault.	
3	Tx_Disable	Transmitter Disable. Laser output disabled on "high" or "open."	2
4	SDA	2-Wire Serial Interface Data.	3
5	SCL	2-Wire Serial Interface Clock.	3
6	MOD_ABS	Module Absent. Grounded within the module.	3
7	RS0	No Connection Required.	
8	LOS	Loss of Signal Indication. "Logic 0" indicates normal operation.	4
9	RS1	No Connection Required.	1
10	VeeR	Receiver Ground (Common with Transmitter Ground).	1
11	VeeR	Receiver Ground (Common with Transmitter Ground).	1
12	RD-	Receiver Inverted Data Out. AC Coupled.	
13	RD+	Receiver Non-Inverted Data Out. AC Coupled.	
14	VeeR	Receiver Ground (Common with Transmitter Ground).	1
15	VccR	Receiver Power Supply.	
16	VccT	Transmitter Power Supply.	
17	VeeT	Transmitter Ground (Common with Receiver Ground).	1
18	TD+	Transmitter Non-Inverted Data In. AC Coupled.	
19	TD-	Transmitter Inverted Data In. AC Coupled.	
20	VeeT	Transmitter Ground (Common with Receiver Ground).	1

Notes:

1. The circuit ground is isolated from the chassis ground.
2. Disabled: TDIS>2V or open, enabled: TDIS<0.8V.
3. Should be pulled up with 4.7k Ω to 10k Ω on the host board to a voltage between 2V and 3.6V.
4. LOS is open collector output.

Electrical Pad Layout



Top of Board



Bottom of Board

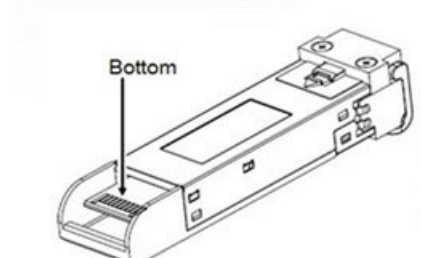
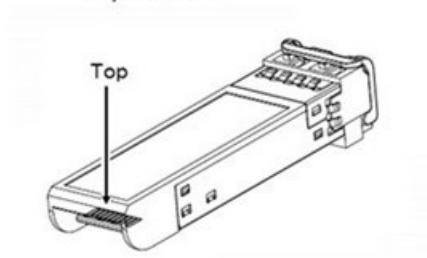

Block Diagram of Transceiver



Mechanical Specifications

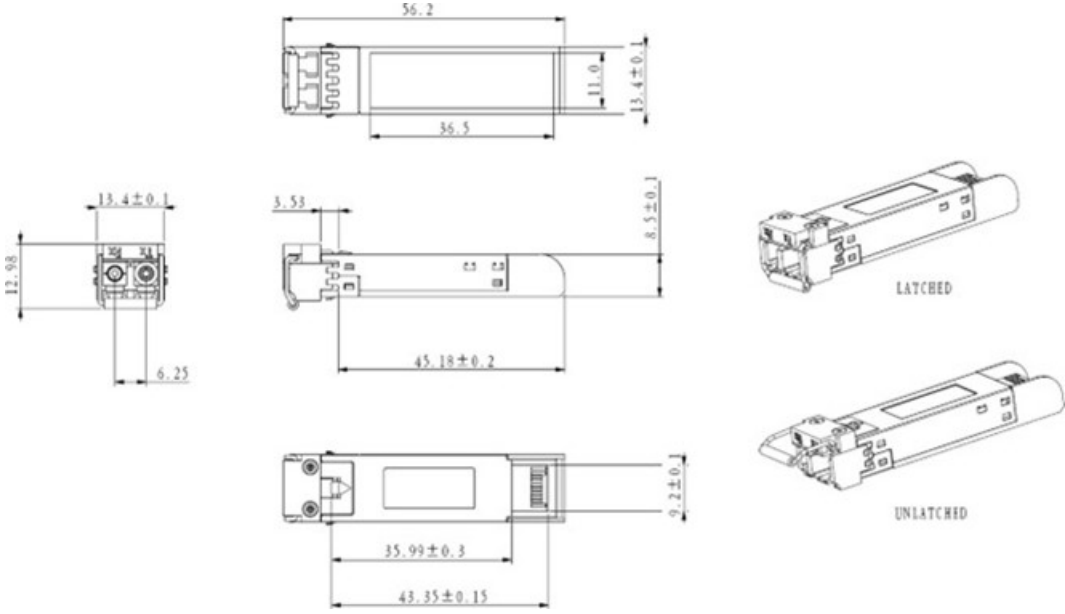

All dimensions are ± 0.2 mm unless otherwise specified.
Unit: mm

About ProLabs

Our extensive experience comes as standard. For over 20 years ProLabs has delivered optical connectivity solutions that give our customers freedom and choice through our ability to provide seamless interoperability. At the heart of our company is the ability to provide state-of-the-art optical transport and connectivity solutions that are compatible with more than 100 optical switching and transport platforms.

A Complete Portfolio of Network Solutions

ProLabs is focused on innovations in optical transport and connectivity. The combination of our knowledge of optics and networking equipment enables ProLabs to be your single source for optical transport and connectivity solutions from 100Mb to 1.6T while providing innovative solutions that increase network efficiency. We provide the optical connectivity expertise that is compatible with and enhances your switching and transport equipment.

The Trusted Partner

Customer service is our number one value. ProLabs has invested in people, labs and manufacturing capacity to ensure compatible products, and immediate answers to your questions. With Engineering and Manufacturing offices in the U.K. and U.S. augmented by field offices throughout the U.S., U.K. and Asia, ProLabs is able to be our customers best advocate 24 hours a day.



Contact Information

ProLabs US

Email: sales@prolabs.com

Telephone: 952-852-0252

ProLabs UK

Email: salessupport@prolabs.com

Telephone: +44 1285 719 600