

XFP-10GB-CW53-80-I-C

MSA and TAA 10GBase-CWDM XFP Transceiver (SMF, 1530nm, 80km, LC, DOM, -40 to 85C)

Features:

- INF-8077i Compliance
- Duplex LC Connector
- Single-mode Fiber
- Industrial Temperature -40 to 85 Celsius
- Hot Pluggable
- Metal with Lower EMI
- Excellent ESD Protection
- RoHS Compliant and Lead Free



Applications:

- 10x Gigabit Ethernet over CWDM
- 8x/10x Fibre Channel
- Access, Metro and Enterprise
- Mobile Fronthaul CPRI/OBSAI

Product Description

This MSA compliant XFP transceiver provides 10GBase-CWDM throughput up to 80km over single-mode fiber (SMF) using a wavelength of 1530nm via an LC connector. It is capable of withstanding rugged environments and can operate at temperatures between -40 and 85C. The listed reach has been determined using a link budget calculation and tested in a standard environment. Actual link distances achieved will be dependent upon the deployed environment. All of our transceivers are built to comply with Multi-Source Agreement (MSA) standards and are uniquely serialized and tested for data-traffic and application to ensure seamless network integration. Additional product features include Digital Optical Monitoring (DOM) support which allows access to real-time operating parameters. This transceiver is Trade Agreements Act (TAA) compliant. We stand behind the quality of our products and proudly offer a limited lifetime warranty.

ProLabs' transceivers are RoHS compliant and lead-free.

TAA refers to the Trade Agreements Act (19 U.S.C. & 2501-2581), which is intended to foster fair and open international trade. TAA requires that the U.S. Government may acquire only "U.S.-made or designated country end products.")



CWDM Available Wavelengths

| Wavelength | Min. | Typ. | Max. |
|------------|------|------|------|
| 47 | 1465 | 1471 | 1477 |
| 49 | 1485 | 1491 | 1497 |
| 51 | 1505 | 1511 | 1517 |
| 53 | 1525 | 1531 | 1537 |
| 55 | 1545 | 1551 | 1557 |
| 57 | 1565 | 1571 | 1577 |
| 59 | 1585 | 1591 | 1597 |
| 61 | 1605 | 1611 | 1617 |

Absolute Maximum Ratings

| Parameter | Symbol | Min. | Typ. | Max. | Unit | Notes |
|----------------------------|--------|------|------|-------------------|------|-------|
| Storage Temperature | Tstg | -40 | | 85 | °C | |
| Supply Voltage - 5V | Vcc5 | -0.5 | | 5.5 | | |
| Supply Voltage - 3.3V | Vcc3 | -0.5 | | 4 | V | |
| Data Rate | DR | 9.95 | | 11.3 | Gbps | |
| Bit Error Rate | BER | | | 10 ⁻¹² | | |
| Operating Case Temperature | Tc | -40 | | 85 | °C | 2 |

Notes:

1. Operating environment.
2. Case temperature.

Electrical Characteristics

| Parameter | Symbol | Min. | Typ. | Max. | Unit | Notes |
|--|---------|---------|------|----------|------|-------|
| Total Power Consumption | PC | | | 2.5 | W | |
| Power Supply Voltage - 5V | Vcc5 | 4.75 | 5.0 | 5.25 | V | 1 |
| Power Supply Voltage - 3.3V | Vcc3 | 3.14 | | 3.46 | V | 1 |
| Power Supply Current - Vcc5 | Icc5 | | | 350 | mA | |
| Power Supply Current - Vcc3 | Icc3 | | | 500 | mA | |
| Transmitter | | | | | | |
| Input Differential Impedance | RIN | | 100 | | Ω | 2 |
| Differential Data Input Swing | VIN,pp | 120 | | 820 | mV | |
| Transmit Disable Voltage | VD | 2 | | Vcc | V | 3 |
| Transmit Enable Voltage | VEN | GND | | GND+0.8 | V | |
| Transmit Disable Assert Time | | | | 10 | us | |
| Receiver | | | | | | |
| Differential Data Output Swing | VOUT,pp | 340 | 650 | 850 | mV | |
| Data Output Rise/Fall Time (20-80%) | Tr/Tf | | | 38 | ps | |
| LOS Fault | VLOSA | Vcc-0.5 | | Host_Vcc | V | |
| LOS Normal | VLOSD | GND | | GND+0.5 | V | |

Notes:

1. Operating environment.
2. After internal AC coupling.
3. Or open circuit.

Optical Characteristics

| Parameter | Symbol | Min. | Typ. | Max. | Unit | Notes |
|---------------------------------|-------------|------|------|------|-------|-------|
| Transmitter | | | | | | |
| Output Optical Power | PTX | 0 | | 4 | dBm | 1 |
| Optical Center Wavelength | λ_C | 1525 | 1531 | 1537 | | |
| Extinction Ratio | ER | 9 | | | dB | |
| Side-Mode Suppression Ratio | SMSR | 30 | | | dB | |
| Relative Intensity Noise | RIN | | | -130 | dB/Hz | |
| Transmitter Dispersion Penalty | TDP | | | 3 | dB | |
| Launch Power of Off Transmitter | Poff | | | -30 | dBm | 1 |
| Transmitter Jitter (Pk-Pk) | TJ | | | 0.1 | UI | |
| Receiver | | | | | | |
| Center Wavelength Range | λ_C | 1260 | | 1600 | nm | |
| Receiver Overload | POL | -7 | | | dBm | |
| Receiver Sensitivity @10.3Gbps | RX_SEN | | | -24 | dBm | 2 |
| Receiver Reflectance | TRRX | | | -27 | dB | |
| LOS Assert | LOSA | -35 | | | dBm | |
| LOS De-Assert | LOSD | | | -27 | dBm | |
| LOS Hysteresis | LOSH | 0.5 | | | dB | |

Notes:

1. Average.
2. Measured with worst ER, BER10^{-12}, and $2^{31}-1$ PRBS.

Pin Descriptions

| Pin | Symbol | Name/Description | Notes |
|-----|------------|---|-------|
| 1 | GND | Module Ground. | 1 |
| 2 | Vee5 | Optional -5.2 Power Supply. Not Required. | |
| 3 | MOD_DESEL | Module De-Select. When held "low," allows the module to respond to 2-wire serial interface commands. | |
| 4 | Interrupt | Indicates the presence of an important condition which can be read over the serial 2-wire interface. | 2 |
| 5 | Tx_Disable | Transmitter Disable. Transmitter laser source is turned off. | |
| 6 | Vcc5 | +5V Power Supply. | |
| 7 | GND | Module Ground. | 1 |
| 8 | Vcc3 | +3.3V Power Supply. | |
| 9 | Vcc3 | +3.3V Power Supply. | |
| 10 | SCL | 2-Wire Serial Interface Clock. | 2 |
| 11 | SDA | 2-Wire Serial Interface Data. | 2 |
| 12 | MOD_ABS | Module Absent. Indicates that the module is not present. Grounded within the module. | 2 |
| 13 | MOD_NR | Module Not Ready. Indicates a module operating fault. | 2 |
| 14 | Rx_LOS | Receiver Loss of Signal Indicator. | 2 |
| 15 | GND | Module Ground. | 1 |
| 16 | GND | Module Ground. | 1 |
| 17 | RD- | Receiver Inverted Data Output. | |
| 18 | RD+ | Receiver Non-Inverted Data Output. | |
| 19 | GND | Module Ground. | 1 |
| 20 | Vcc2 | +1.8V Power Supply. | |
| 21 | PDown/RST | Power Down. When "high," places the module in the low-power stand-by mode and, on the falling edge of P_Down, initiates a module reset. Reset. The falling edge initiates a complete reset of the module including the 2-wire serial interface, equivalent to a power cycle. | |
| 22 | Vcc2 | +1.8V Power Supply. | |
| 23 | GND | Module Ground. | 1 |
| 24 | RefCLK+ | Reference Clock Non-Inverted Input. AC coupled on the host board. | |
| 25 | RefCLK- | Reference Clock Inverted Input. AC coupled on the host board. | |
| 26 | GND | Module Ground. | 1 |
| 27 | GND | Module Ground. | 1 |
| 28 | TD- | Transmitter Inverted Data Input. | |
| 29 | TD+ | Transmitter Non-Inverted Data Input. | |
| 30 | GND | Module Ground. | 1 |

Notes:

1. The module ground pins (GND) are isolated from the module case and chassis ground within the module.
2. Open collector. Should be pulled up with 4.7kΩ to 10kΩ on the host board to a voltage between 3.15V and 3.6V.

Electrical Pad Layout

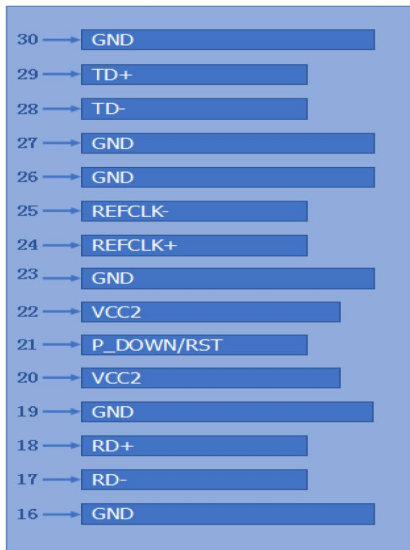

Top of Board

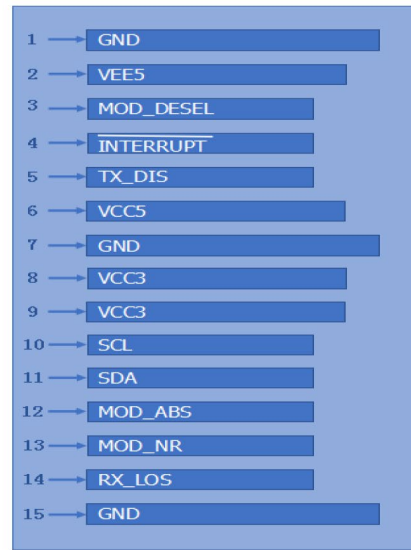

Bottom of Board

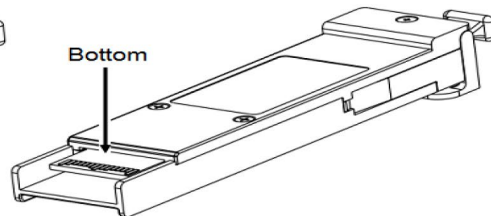
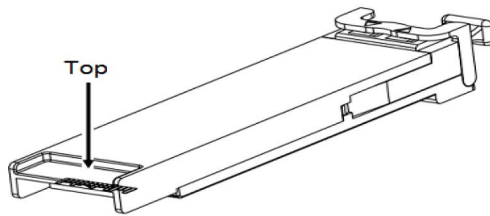

Block Diagram

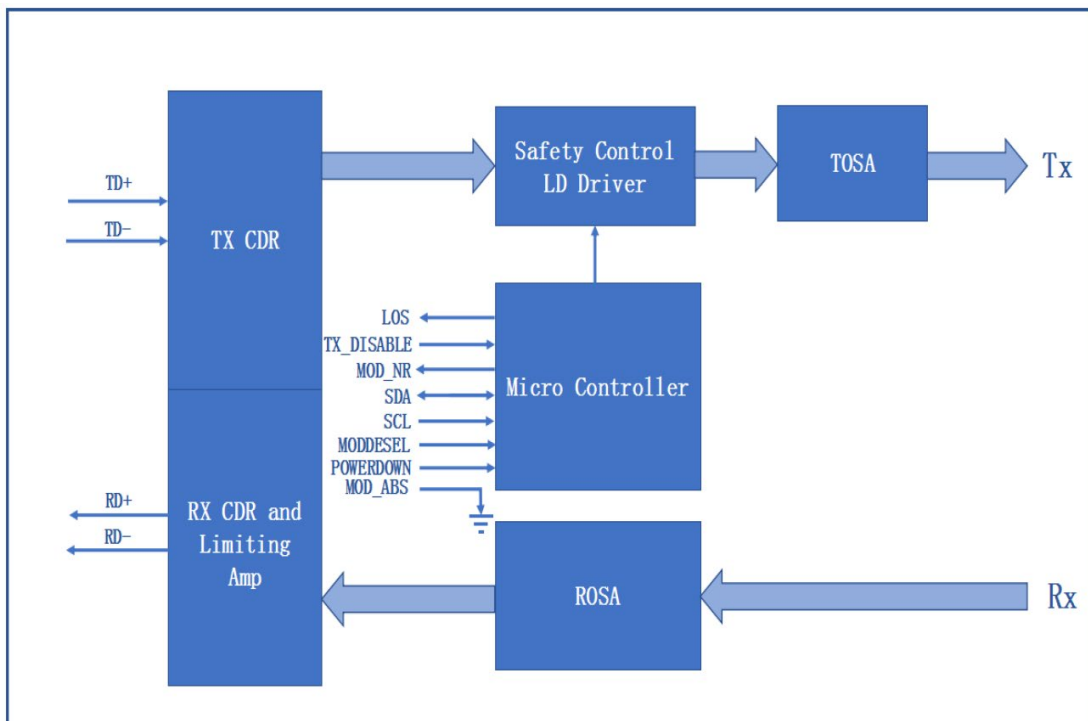

Mechanical Specifications

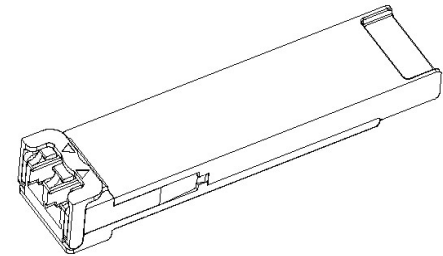
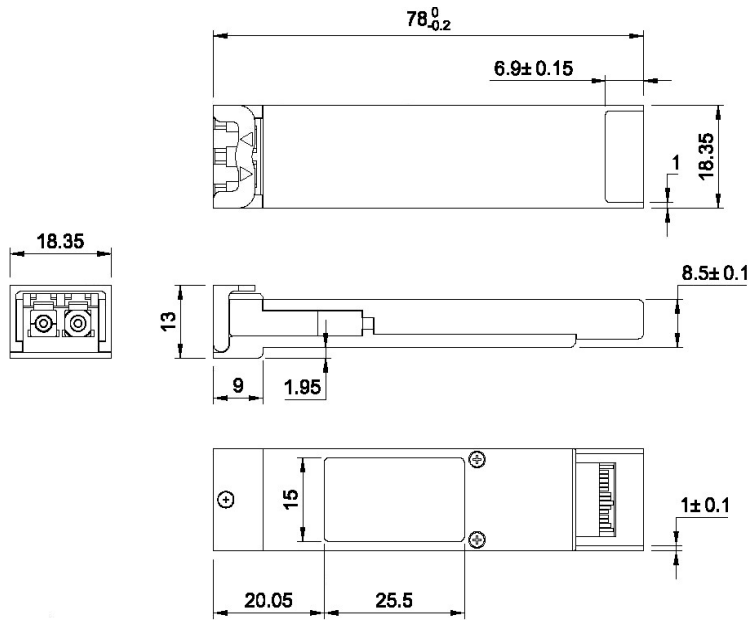

LATCHED

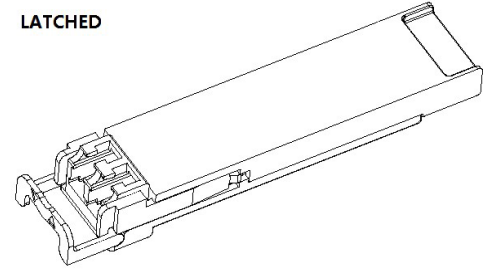

UNLATCHED

All dimensions are ± 0.2 mm unless otherwise specified.

Unit: mm

About ProLabs

Our extensive experience comes as standard. For over 20 years ProLabs has delivered optical connectivity solutions that give our customers freedom and choice through our ability to provide seamless interoperability. At the heart of our company is the ability to provide state-of-the-art optical transport and connectivity solutions that are compatible with more than 100 optical switching and transport platforms.

A Complete Portfolio of Network Solutions

ProLabs is focused on innovations in optical transport and connectivity. The combination of our knowledge of optics and networking equipment enables ProLabs to be your single source for optical transport and connectivity solutions from 100Mb to 1.6T while providing innovative solutions that increase network efficiency. We provide the optical connectivity expertise that is compatible with and enhances your switching and transport equipment.

The Trusted Partner

Customer service is our number one value. ProLabs has invested in people, labs and manufacturing capacity to ensure compatible products, and immediate answers to your questions. With Engineering and Manufacturing offices in the U.K. and U.S. augmented by field offices throughout the U.S., U.K. and Asia, ProLabs is able to be our customers best advocate 24 hours a day.



Contact Information

ProLabs US

Email: sales@prolabs.com

Telephone: 952-852-0252

ProLabs UK

Email: salessupport@prolabs.com

Telephone: +44 1285 719 600