

## FTLC1121RDNL-AO

Finisar® FTLC1121RDNL Compatible TAA 100GBase-LR4 CFP2 Transceiver (SMF, 1310nm, 10km, LC, DOM)

### Features

- CFP MSA 1.0 Compliance
- Duplex LC Connector
- Commercial Temperature 0 to 70 Celsius
- Single-mode Fiber
- Hot Pluggable
- Excellent ESD Protection
- Metal with Lower EMI
- RoHS Compliant and Lead Free



### Applications

- OTU4 Operation
- 100GBase Ethernet
- Access and Enterprise

### Product Description

This Finisar® FTLC1121RDNL compatible CFP2 transceiver provides 100GBase-LR4 throughput up to 10km over single-mode fiber (SMF) using a wavelength of 1310nm via an LC connector. It is guaranteed to be 100% compatible with the equivalent Finisar® transceiver. This easy to install, hot swappable transceiver has been programmed, uniquely serialized and data-traffic and application tested to ensure that it will initialize and perform identically. Digital optical monitoring (DOM) support is also present to allow access to real-time operating parameters. This transceiver is Trade Agreements Act (TAA) compliant. We stand behind the quality of our products and proudly offer a limited lifetime warranty.

AddOn's transceivers are RoHS compliant and lead-free.

TAA refers to the Trade Agreements Act (19 U.S.C. & 2501-2581), which is intended to foster fair and open international trade. TAA requires that the U.S. Government may acquire only "U.S. – made or designated country end products."



### Absolute Maximum Ratings

| Parameter                        | Symbol | Min. | Max. | Unit | Notes |
|----------------------------------|--------|------|------|------|-------|
| Storage Temperature              | TS     | -40  | +85  | °C   |       |
| Power Supply Voltage             | VCC    | -0.5 | 3.6  | V    |       |
| Operating Case Temperature Range | Tc     | 0    | +70  | °C   |       |
| Relative Humidity                | Rh     | 5    | 85   | %    |       |
| ESD                              |        |      | 500  | V    | 2     |

### Notes:

1. Exceeding any one of these values may destroy the device immediately.
2. Human body model.

### Electrical Characteristics

| Parameter                     | Symbol | Min. | Typ. | Max. | Unit | Notes               |
|-------------------------------|--------|------|------|------|------|---------------------|
| Power Supply Voltage          | VCC    | 3.2  | 3.3  | 3.4  | V    |                     |
| Power Consumption             | P      |      |      | 6    | W    |                     |
| <b>Transmitter</b>            |        |      |      |      |      |                     |
| Differential Input Amplitude  | Vin    |      |      | 900  | mVpp | AC coupled inputs   |
| Input differential impedance  | Zin    | 80   | 100  | 115  | Ω    | Rin > 100kohms @ DC |
| <b>Receiver</b>               |        |      |      |      |      |                     |
| Differential output amplitude | Vout   |      |      | 900  | mVpp | AC coupled outputs  |
| Output differential impedance | Zoout  | 80   | 100  | 120  | Ω    |                     |

## 1.2V MDIO Interface Specifications

| Parameter                          | Symbol                   | Min. | Typ. | Max   | Unit | Notes |
|------------------------------------|--------------------------|------|------|-------|------|-------|
| Input Voltage                      | V <sub>IH</sub>          | 0.84 |      | 1.5   | V    |       |
|                                    | V <sub>IL</sub>          | -0.3 |      | 0.36  | V    |       |
| Input Leak current                 | I <sub>IN</sub>          | -100 |      | 100   | uA   |       |
| Output Voltage                     | V <sub>OH</sub>          | 1.0  |      | 1.5   | V    |       |
|                                    | V <sub>OL</sub>          | -0.3 |      | 0.2   | V    |       |
| Input Capacitance                  | C <sub>I</sub>           |      |      | 10    | pF   |       |
| Input MDC Clock                    | f <sub>MDC</sub>         | 0.1  |      | 4     | MHz  |       |
| MDC Clock Period                   | T <sub>MDC</sub>         | 250  |      | 10000 | ns   |       |
| MDIO Hold Time                     | T <sub>hold</sub>        | 10   |      |       | ns   |       |
| MDIO Setup Time                    | T <sub>setup</sub>       | 10   |      |       | ns   |       |
| Clock to output delay from the MMD | T <sub>dely</sub>        | 0    |      | 300   | ns   |       |
| GLB_ALM                            | T <sub>glb_alm_ass</sub> |      |      | 150   | ms   |       |
|                                    | T <sub>glb_alm_dea</sub> |      |      | 150   | ms   |       |
| MDC High time                      | T <sub>high</sub>        |      |      | 160   | ns   |       |
| MDC Low time                       | T <sub>low</sub>         |      |      | 160   | ns   |       |

## OTU4 Operation Optical Characteristics

| Parameter   | Symbol         | Min.              | Typical | Max.    | Unit | Notes |
|---|----------------|-------------------|---------|---------|------|-------|
| <b>Transmitter</b>  |                |                   |         |         |      |       |
| Signaling Speed per Lane                                    | BRAVE          |                   | 27.95   |         | Gbps |       |
| Data Rate Variation   |                | -20               |         | +20     |      |       |
| Lane_0 Center Wavelength                                    | $\lambda_{C0}$ | 1294.53           | 1295.56 | 1296.59 | nm   |       |
| Lane_1 Center Wavelength                                    | $\lambda_{C1}$ | 1299.02           | 1300.05 | 1301.09 | nm   |       |
| Lane_2 Center Wavelength                                    | $\lambda_{C2}$ | 1303.54           | 1304.58 | 1305.63 | nm   |       |
| Lane_3 Center Wavelength                                    | $\lambda_{C3}$ | 1308.09           | 1309.14 | 1310.19 | nm   |       |
| Total Average Output Power                                  | PO1            |                   |         | 8.9     | dBm  | 1, 2  |
| Average Launch Power per Lane                               | Peach1         | -2.5              |         | 2.9     | dBm  | 2     |
| Maximum channel power difference                            |                |                   |         | 5       | dB   |       |
| Side Mode Suppression Ratio                                 | SMSR           | 30                |         |         | dB   |       |
| Optical Return Loss Tolerance                               |                |                   |         | 20      | dB   | 2     |
| Extinction Ratio  | ER1            | 7                 |         |         | dB   |       |
| Transmitter eye mask definition<br>{X1, X2, X3, Y1, Y2, Y3} |                | G.959.1 Compliant |         |         |      | 2     |
| Optical Eye Mask Margin                                     | MM             | 5                 |         |         | %    | 3     |
| TX Disable Assert Time                                      | t_off          |                   |         | 100     | us   |       |
| <b>Receiver</b>   |                |                   |         |         |      |       |
| Signaling Speed per Lane                                    | BRAVE          |                   | 27.95   |         | Gbps |       |
| Data Rate Variation   |                | -20               |         | +20     | ppm  |       |
| Lane_0 Center Wavelength                                    | $\lambda_{C0}$ | 1294.53           | 1295.56 | 1296.59 | nm   |       |
| Lane_1 Center Wavelength                                    | $\lambda_{C1}$ | 1299.02           | 1300.05 | 1301.09 | nm   |       |
| Lane_2 Center Wavelength                                    | $\lambda_{C2}$ | 1303.54           | 1304.58 | 1305.63 | nm   |       |
| Lane_3 Center Wavelength                                    | $\lambda_{C3}$ | 1308.09           | 1309.14 | 1310.19 | nm   |       |
| Average Receive Power per Lane                              | Rpow1          | -8.8              |         | 2.9     | dBm  | 4     |
| Equivalent Sensitivity per Lane                             | Pmin1          |                   |         | -10.3   | dBm  | 5     |
| Damage Threshold per Lane                                   | Pmax           | 5.5               |         |         | dBm  |       |
| Maximum channel power difference                            |                |                   |         | 5.5     | dB   |       |
| Maximum optical path penalty                                |                |                   |         | 1.5     | dB   |       |
| Optical Return Loss   | ORL            |                   |         | -26     | dB   |       |
| LOS Assert  | LOSA           | -21               | -17     | -16     | dBm  |       |
| LOS De-Assert   | LOSD           |                   | -16     | -15     | dBm  |       |
| LOS Hysteresis  |                | 0.5               |         |         | dB   |       |

**Notes:**

1. Output is coupled into a 9/125µm single-mode fiber.
2. Filtered, measured with a PRBS 2<sup>31</sup>-1 test pattern @27.95Gbps
3. Eye Margin within 1000 waveforms.
4. CFP2 transceiver works in OTU4 411-9D1F mode.
5. Minimum average optical power measured at BER less than 1E-12, with a 2<sup>31</sup>-1 PRBS@27.95Gbps.

**100GBASE-LR4 Operation Optical Characteristics**

| Parameter  | Symbol | Min.                       | Typical | Max.    | Unit | Notes |   |
|--|--------|----------------------------|---------|---------|------|-------|---|
| <b>Transmitter</b>                                       |        |                            |         |         |      |       |   |
| Signaling Speed per Lane                                 | BRAVE  |                            | 25.78   |         | Gbps |       |   |
| Data Rate Variation                                      |        | -100                       |         | +100    | ppm  |       |   |
| Lane_0 Center Wavelength                                 | λC0    | 1294.53                    | 1295.56 | 1296.59 | nm   |       |   |
| Lane_1 Center Wavelength                                 | λC1    | 1299.02                    | 1300.05 | 1301.09 | nm   |       |   |
| Lane_2 Center Wavelength                                 | λC2    | 1303.54                    | 1304.58 | 1305.63 | nm   |       |   |
| Lane_3 Center Wavelength                                 | λC3    | 1308.09                    | 1309.14 | 1310.19 | nm   |       |   |
| Total Average Output Power                               | PO2    | -                          |         | 10.5    | dBm  | 1, 2  |   |
| Average Launch Power per Lane                            | Peach2 | -4.3                       |         | 4.5     | dBm  | 2     |   |
| Side Mode Suppression Ratio                              | SMSR   | 30                         |         |         | dB   |       |   |
| Difference in launch power between any two lanes         |        |                            |         | 5       | dB   |       |   |
| Average launch power of OFF transmitter per lane         |        |                            |         | -30     | dBm  |       |   |
| Optical Return Loss Tolerance                            |        |                            |         | 20      | dB   |       |   |
| Transmitter reflectance                                  |        |                            |         | -12     | dB   |       |   |
| Extinction Ratio   | ER     | 4                          |         |         | dB   | 2     |   |
| Transmitter eye mask definition {X1, X2, X3, Y1, Y2, Y3} |        | IEEE802.3ba-2010 Compliant |         |         |      |       | 2 |
| Optical Eye Mask Margin                                  | MM     | 5                          |         |         | %    | 3     |   |
| TX Disable Assert Time                                   | t_off  |                            |         | 100     | us   |       |   |
| <b>Receiver</b>  |        |                            |         |         |      |       |   |
| Signaling Speed per Lane                                 | BRAVE  |                            | 25.78   |         | Gbps |       |   |
| Data Rate Variation                                      |        | -100                       |         | +100    | ppm  |       |   |
| Lane_0 Center Wavelength                                 | λC0    | 1294.53                    | 1295.56 | 1296.59 | nm   |       |   |
| Lane_1 Center Wavelength                                 | λC1    | 1299.02                    | 1300.05 | 1301.09 | nm   |       |   |
| Lane_2 Center Wavelength                                 | λC2    | 1303.54                    | 1304.58 | 1305.63 | nm   |       |   |
| Lane_3 Center Wavelength                                 | λC3    | 1308.09                    | 1309.14 | 1310.19 | nm   |       |   |
| Average Receive Power per Lane                           | Rpow2  | -10.6                      |         | 4.5     | dBm  | 4     |   |
| Receive Sensitivity (OMA) per lane                       | Pmin2  |                            |         | -8.6    | dBm  | 5     |   |

|  |      |     |     |      |     |   |
|--|------|-----|-----|------|-----|---|
| <b>Stressed Sensitivity (OMA) per lane</b> | SRS  |     |     | -6.8 | dBm |   |
| <b>Damage Threshold per Lane</b>           | Pmax | 5.5 |     |      | dBm |   |
| <b>Optical Return Loss</b>                 | ORL  |     |     | -26  | dB  |   |
| <b>LOS Assert</b>                          | LOSA | -21 | -17 | -16  | dBm |   |
| <b>LOS De-Assert</b>                       | LOSD |     | -16 | -15  | dBm |   |
| <b>LOS Hysteresis</b>                      |      | 0.5 |     |      | dB  | 6 |

**Notes:**

1. Output is coupled into a 9/125µm single-mode fiber.
2. Filtered, measured with a PRBS 2<sup>31</sup>-1 test pattern @25.78Gbps
3. Eye Margin within 1000 waveforms.
4. CFP2 transceiver works in 100GBASE-LR4 mode
5. Minimum average optical power measured at BER less than 1E-12, with a 2<sup>31</sup>-1 PRBS@25.78Gbps.
6. LOS Hysteresis

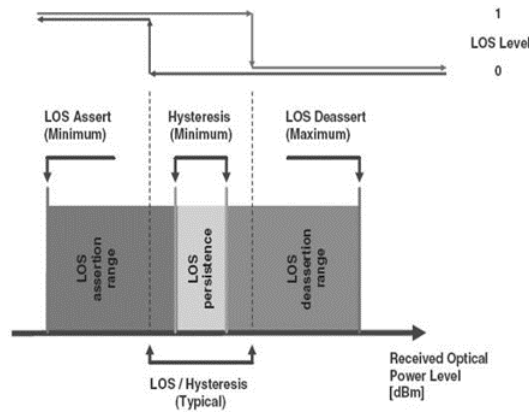

**Functional Description of Transceiver**

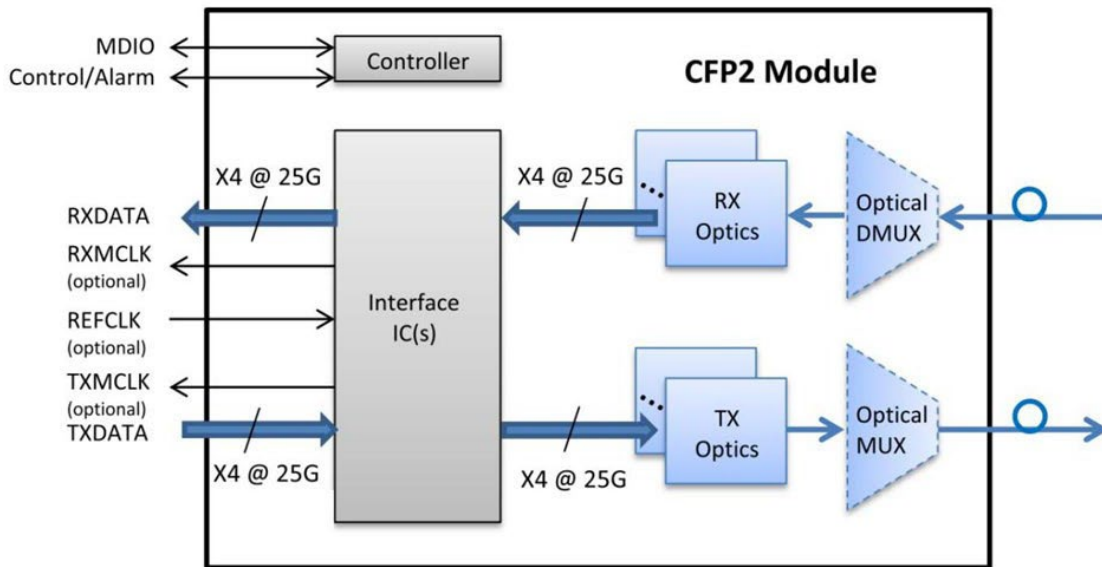

## Electrical Pad Layout

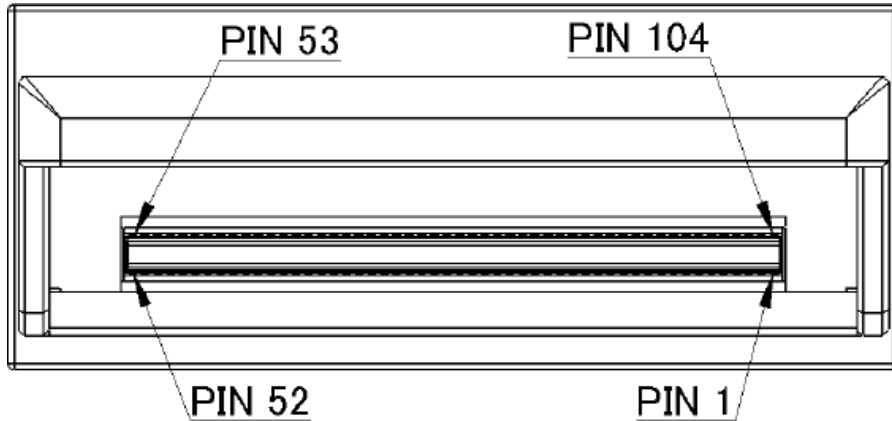

## Pin Descriptions

### Part A: Bottom Row Pin Function Definition

| Pin | Name       | Function | Notes   |
|-----|------------|----------|---|
| 1   | GND        |          |   |
| 2   | (TX_MCK_N) | O CML    | For optical waveform testing. Not for normal use.   |
| 3   | (TX_MCK_P) | O CML    | For optical waveform testing. Not for normal use.   |
| 4   | GND        |          |   |
| 5   | N.C.       |          |   |
| 6   | N.C.       |          |   |
| 7   | 3.3V_GND   |          |   |
| 8   | 3.3V_GND   |          |   |
| 9   | 3.3V       |          | 3.3V Module Supply Voltage  |
| 10  | 3.3V       |          | 3.3V Module Supply Voltage  |
| 11  | 3.3V       |          | 3.3V Module Supply Voltage  |
| 12  | 3.3V       |          | 3.3V Module Supply Voltage  |
| 13  | 3.3V_GND   |          |   |
| 14  | 3.3V_GND   |          |   |
| 15  | VND_IO_A   |          | Module Vendor I/O A. Do not connect!  |
| 16  | VND_IO_B   |          | Module Vendor I/O B. Do not connect!  |
| 17  | PRG_CNTL1  |          | Programmable control 1 set over MDIO, MSA default: TRXIC_RSTn. TX&RX ICs reset. "0": reset; "1" or NC: enabled = not used               |
| 18  | PRG_CNTL2  |          | Programmable Control 2 set over MDIO, MSA Default: Hardware Interlock LSB, "00": ≤3W, "01": ≤6W, "10": ≤9W, "11" or NC: ≤12W = not used |
| 19  | PRG_CNTL3  |          | Programmable Control 3 set over MDIO, MSA Default: Hardware Interlock MSB, "00": ≤3W, "01": ≤6W, "10": ≤9W, "11" or NC: ≤12W = not used |
| 20  | PRG_ALARM1 |          | Programmable alarm 1 set over MDIO, MSA default: HIPWR_ON. "1": module power up completed; "0": module not high powered up.             |
| 21  | PRG_ALARM2 |          | Programmable alarm 2 set over MDIO, MSA default: MOD_READY. "1": ready; "0": not ready.   |
| 22  | PRG_ALARM3 |          | Programmable alarm 3 set over MDIO, MSA default: MOD_FAULT, fault detected. "1": fault; "0": not fault.                                 |
| 23  | GND        |          |   |
| 24  | TX_DIS     | I LVCMOS | Transmitter disable for all lanes. "1" or NC: transmitter disabled; "0": transmitter enabled.   |

|    |            |               |  |
|----|------------|---------------|--|
| 25 | RX_LOS     | O LVCMOS      | Receiver loss of optical signal. "1": low optical signal; "0": normal condition.   |
| 26 | MOD_LOPWR  | I LVCMOS      | Module Low power mode. "1" or NC: module in low power (safe) mode; "0": power-on enabled.                                    |
| 27 | MOD_ABS    | O GND         | Module Absent. "1" or NC: module absent; "0": module present. Pull up resistor on Host.                                      |
| 28 | MOD_RSTn   | I LVCMOS      | Module Reset. "0": resets the module; "1" or NC: module enabled. Pull Down Resistor in module.                               |
| 29 | GLB_ALRMn  | O LVCMOS      | Global Alarm. "0": alarm condition in any MDIO alarm register; "1": no alarm condition. Open Drain, Pull up resistor on Host |
| 30 | GND        |               |  |
| 31 | MDC        | I 1.2V CMOS   | Management Data Clock  |
| 32 | MDIO       | I/O 1.2V CMOS | Management Data I/O bi-directional data  |
| 33 | PRTADR0    | I 1.2V CMOS   | MDIO Physical Port address bit 0   |
| 34 | PRTADR1    | I 1.2V CMOS   | MDIO Physical Port address bit 1   |
| 35 | PRTADR2    | I 1.2V CMOS   | MDIO Physical Port address bit 2   |
| 36 | VND_IO_C   | I/O           | Module Vendor I/O C. Do not connect!   |
| 37 | VND_IO_D   | I/O           | Module Vendor I/O D. Do not connect!   |
| 38 | VND_IO_E   | I/O           | Module Vendor I/O E. Do not connect!   |
| 39 | 3.3V_GND   |               |  |
| 40 | 3.3V_GND   |               |  |
| 41 | 3.3V       |               | 3.3V Module Supply Voltage   |
| 42 | 3.3V       |               | 3.3V Module Supply Voltage   |
| 43 | 3.3V       |               | 3.3V Module Supply Voltage   |
| 44 | 3.3V       |               | 3.3V Module Supply Voltage   |
| 45 | 3.3V_GND   |               |  |
| 46 | 3.3V_GND   |               |  |
| 47 | N.C.       |               | No Connect   |
| 48 | N.C.       |               | No Connect   |
| 49 | GND        |               |  |
| 50 | (RX_MCK_N) | O CML         | For optical waveform testing. Not for normal use.  |
| 51 | (RX_MCK_P) | O CML         | For optical waveform testing. Not for normal use.  |
| 52 | GND        |               |  |

#### Part B: Top Row Pin Function Definition

| Pin | Name | Function           | Notes      |
|-----|------|--------------------|------------|
| 53  | GND  |                    |            |
| 54  | N.C. |                    |            |
| 55  | N.C. |                    |            |
| 56  | GND  |                    |            |
| 57  | RX0p | Lane 0 Rx Output O | CML Output |
| 58  | RX0n | Lane 0 Rx Output O | CML Output |
| 59  | GND  |                    |            |
| 60  | RX1p | Lane 1 Rx Output O | CML Output |
| 61  | RX1n | Lane 1 Rx Output O | CML Output |
| 62  | GND  |                    |            |
| 63  | N.C. |                    |            |
| 64  | N.C. |                    |            |



|     |           |                    |                       |
|-----|-----------|--------------------|-----------------------|
| 65  | GND       |                    |                       |
| 66  | N.C.      |                    |                       |
| 67  | N.C.      |                    |                       |
| 68  | GND       |                    |                       |
| 69  | RX2p      | Lane 2 Rx Output O | CML Output            |
| 70  | RX2n      | Lane 2 Rx Output O | CML Output            |
| 71  | GND       |                    |                       |
| 72  | RX3p      | Lane 3 Rx Output O | CML Output            |
| 73  | RX3n      | Lane 3 Rx Output O | CML Output            |
| 74  | GND       |                    |                       |
| 75  | N.C.      |                    |                       |
| 76  | N.C.      |                    |                       |
| 77  | GND       |                    |                       |
| 78  | (REFCLKn) | Reference Clock I  | Reference Clock Input |
| 79  | (REFCLKp) | Reference Clock I  | Reference Clock Input |
| 80  | GND       |                    |                       |
| 81  | N.C.      |                    |                       |
| 82  | N.C.      |                    |                       |
| 83  | GND       |                    |                       |
| 84  | TX0p      | Lane 0 Tx Input I  | CML Input             |
| 85  | TX0n      | Lane 0 Tx Input I  | CML Input             |
| 86  | GND       |                    |                       |
| 87  | TX1p      | Lane 1 Tx Input I  | CML Input             |
| 88  | TX1n      | Lane 1 Tx Input I  | CML Input             |
| 89  | GND       |                    |                       |
| 90  | N.C.      |                    |                       |
| 91  | N.C.      |                    |                       |
| 92  | GND       |                    |                       |
| 93  | N.C.      |                    |                       |
| 94  | N.C.      |                    |                       |
| 95  | GND       |                    |                       |
| 96  | TX2p      | Lane 2 Tx Input I  | CML Input             |
| 97  | TX2n      | Lane 2 Tx Input I  | CML Input             |
| 98  | GND       |                    |                       |
| 99  | TX3p      | Lane 3 Tx Input I  | CML Input             |
| 100 | TX3n      | Lane 3 Tx Input I  | CML Input             |
| 101 | GND       |                    |                       |
| 102 | N.C.      |                    |                       |
| 103 | N.C.      |                    |                       |
| 104 | GND       |                    |                       |

# Mechanical Specifications

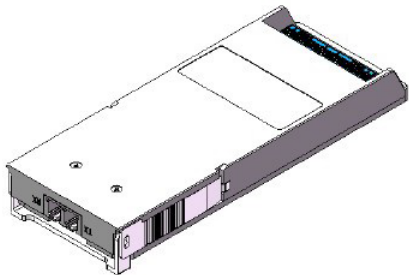
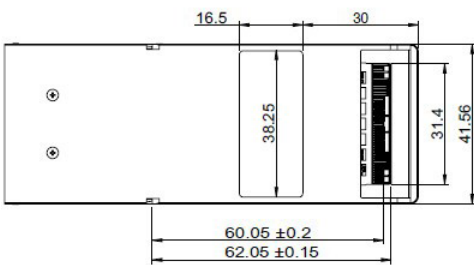
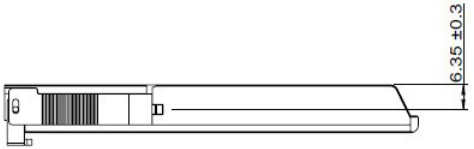
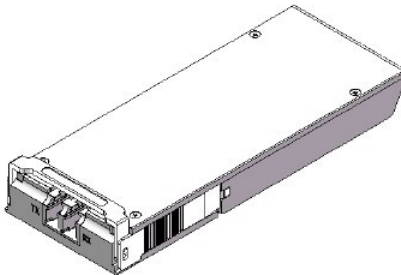
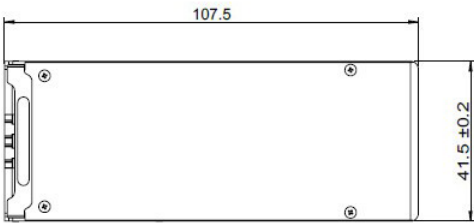
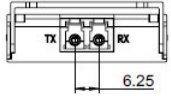
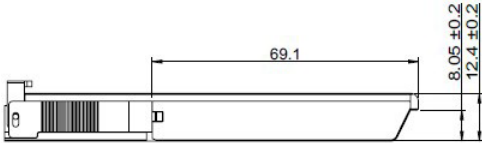

## **About AddOn Networks**

In 1999, AddOn Networks entered the market with a single product. Our founders fulfilled a severe shortage for compatible, cost-effective optical transceivers that compete at the same performance levels as leading OEM manufacturers. Adhering to the idea of redefining service and product quality not previously had in the fiber optic networking industry, AddOn invested resources in solution design, production, fulfillment, and global support.

Combining one of the most extensive and stringent testing processes in the industry, an exceptional free tech support center, and a consistent roll-out of innovative technologies, AddOn has continually set industry standards of quality and reliability throughout its history.

Reliability is the cornerstone of any optical fiber network and is engrained in AddOn's DNA. It has played a key role in nurturing the long-term relationships developed over the years with customers. AddOn remains committed to exceeding industry standards with certifications from ranging from NEBS Level 3 to ISO 9001:2005 with every new development while maintaining the signature reliability of its products.



## **U.S. Headquarters**

Email: [sales@addonnetworks.com](mailto:sales@addonnetworks.com)

Telephone: +1 877.292.1701

Fax: 949.266.9273

## **Europe Headquarters**

Email: [salesupportemea@addonnetworks.com](mailto:salesupportemea@addonnetworks.com)

Telephone: +44 1285 842070