

### SFP-25GB-CW-33-10-HW2-C

Huawei® Compatible TAA 25GBase-CWDM SFP28 Transceiver (SMF, 1330nm, 10km, LC, DOM)

#### Features:

- SFF-8432 and SFF-8472 Compliance
- Duplex LC Connector
- Built-in dual CDR with bypass function
- Single-mode Fiber
- Commercial Temperature 0 to 70 Celsius
- Up to 10km on 9/125um SMF
- Single +3.3V power supply
- Hot Pluggable
- Metal with Lower EMI
- Excellent ESD Protection
- RoHS Compliant and Lead Free
- RoHS compliant and lead-free



#### Applications:

- 25x Gigabit Ethernet over CWDM
- Access, Metro and Enterprise
- Mobile Fronthaul CPRI/OBSAI

#### Product Description

This Huawei® compatible SFP28 transceiver provides 25GBase-CWDM throughput up to 10km over single-mode fiber (SMF) using a wavelength of 1330nm via an LC connector. Our transceiver is built to meet or exceed OEM specifications and is guaranteed to be 100% compatible with Huawei®. It has been programmed, uniquely serialized, and tested for data-traffic and application to ensure that it will initialize and perform identically. All of our transceivers comply with Multi-Source Agreement (MSA) standards to provide seamless network integration. Additional product features include Digital Optical Monitoring (DOM) support which allows access to real-time operating parameters. This transceiver is Trade Agreements Act (TAA) compliant. We stand behind the quality of our products and proudly offer a limited lifetime warranty.

ProLabs' transceivers are RoHS compliant and lead-free.

TAA refers to the Trade Agreements Act (19 U.S.C. & 2501-2581), which is intended to foster fair and open international trade. TAA requires that the U.S. Government may acquire only "U.S.-made or designated country end products.")



## Regulatory Compliance

- ESD to the Electrical PINs: compatible with MIL-STD-883E Method 3015.4
- ESD to the LC Receptacle: compatible with IEC 61000-4-3
- EMI/EMC compatible with FCC Part 15 Subpart B Rules, EN55022:2010
- Laser Eye Safety compatible with FDA 21CFR, EN60950-1& EN (IEC) 60825-1,2
- RoHS compliant with EU RoHS 2.0 directive 2015/863/EU

## Absolute Maximum Ratings

Parameter	Symbol	Min.	Typ.	Max.	Unit	Notes
Maximum Supply Voltage	Vcc	-0.5		4.0	V	1
Storage Temperature	Tstg	-40		85	°C	2
Operating Case Temperature	Tc	0		70	°C	3
Data Rate	DR		24.3	26.5	Gb/s	4
Bit Error Rate	BER			5×10 <sup>-5</sup>		5

### Notes:

1. For Electrical power interface.
2. Ambient Temperature.
3. Case Temperature.
4. IEEE 802.3cc.
5. Measured with data rate at 25.78GBps, PRBS 2<sup>31</sup> – 1.

## Electrical Characteristics

Parameter	Symbol	Min.	Typ.	Max.	Unit	Notes
Power Supply Voltage	Vcc	3.14	3.3	3.46	V	
Module Supply Current	Icc		220	450	mA	1
<b>Transmitter</b>						
Input Differential Impedance	RIN		100		Ω	
Differential Data Input Swing	VIN, pp	250		900	mV	
Transmit Disable Voltage	Vd	2		Vcc	V	
Transmit Enable Voltage	Ven	Vee		Vee+0.8	V	
<b>Receiver</b>						
Differential Data Output Swing	Vout_pp	300		850	mV	
LOS Assert	Vlos_a	2		Vcc_host	V	
LOS De-Assert	Vlos_d	Vee		Vee+0.8	V	

### Notes:

1. For electrical power interface.

## Optical Characteristics

Parameter	Symbol	Min.	Typ.	Max.	Unit	Notes
<b>Transmitter</b>						
Output Optical Power	Ptx	2	4.5	7	dBm	1
Optical Center Wavelength	$\lambda_c$	$\lambda_c - 6.5$	$\lambda_c$	$\lambda_c + 6.5$	nm	2
Transmitter and Dispersion Penalty	TDP			2.7	dB	
Extinction Ratio	ER	3.5			dB	
Spectral Width(-20dB)	$\Delta\lambda$			1	nm	
Side Mode Suppression Ratio	SMSR	30			dB	
Transmitter Reflectance				12	dB	
Launch Power of OFF Transmitter	Pout_off			-30	dBm	1
<b>Receiver</b>						
Optical Center Wavelength	$\lambda_c$	1260		1390	nm	
Receive Overload	Pol	2			dBm	
Receiver Sensitivity (OMA)@ 25.78 Gbps	Rx_sen			-13.3	dBm	3
Receiver Reflectance	TRrx			-26	dB	
LOS Assert	LOSA	-30			dBm	
LOS De-Assert	LOSD			-14	dBm	
LOS Hysteresis	LOSH	0.5			dB	

### Notes:

1. Average.
2.  $\lambda_c = 1271, 1291, 1311, 1331, 1351, 1371$ .
3. Average optical power, measured with data rate at 25.78Gbps, PRBS  $2^{31} - 1$ .

## Pin Descriptions

Pin	Symbol	Name/Descriptions	Notes
1	VeeT	Transmitter Ground. Common with receiver ground.	1
2	TX_Fault	Transmitter Fault.	2
3	TX_Disable	Transmitter Disable. Laser output disables on high or open.	3
4	SDA	Two wire serial interface Data Line.	4
5	SCL	Two wire serial interface Clock Line.	4
6	MOD_ABS	Module Absent. Grounded within the module.	4
7	RS0	No connection required.	
8	LOS	Loss of signal indication. Logic 0 indicated normal operation.	5
9	RS1	No connection required.	1
10	VeeR	Receiver Ground. Common with transmitter ground.	1
11	VeeR	Receiver Ground. Common with transmitter ground.	1
12	RD-	Receiver Inverted DATA out. AC coupled.	
13	RD+	Receiver Non-Inverted DATA out. AC coupled.	
14	VeeR	Receiver Ground. Common with transmitter ground.	1
15	VccR	Receiver power supply.	
16	VccT	Transmitter power supply.	
17	VeeT	Transmitter ground. Common with receiver ground.	1
18	TD+	Transmitter Non-Inverted Data in. AC coupled.	
19	TD-	Transmitter Inverted Data in. AC coupled.	
20	VeeT	Transmitter Ground. Common with receiver ground.	1

### Notes:

1. Circuit ground is isolated from chassis ground.
2. TX\_Fault is the open collector output and should be pulled up with 4.7k $\Omega$ -10k $\Omega$  on host board to a voltage between 2V and Vcc+0.3V.
3. Disables: T<sub>DIS</sub>>2V or open, Enabled T<sub>DIS</sub><0.8V.
4. Should be pulled up with 4.7k $\Omega$ -10k $\Omega$  on host board to a voltage between 2V and Vcc+0.3V.
5. LOS is open collector output and should be pulled up with 4.7k $\Omega$ -10k $\Omega$  on host board to a voltage between 2V and Vcc0.3V, the logic "0" indicated normal operation, and the logic "1" indicates that the receiver signal is lost.

## Block Diagram of Transceiver

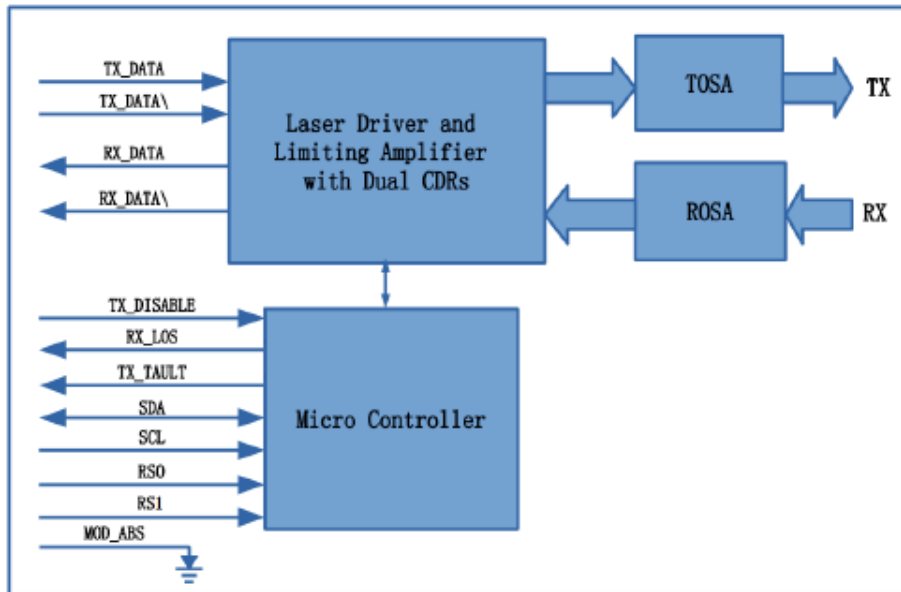

## Electrical Pad Layout

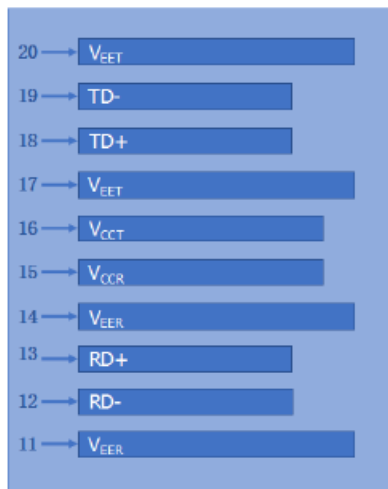

Top of Board

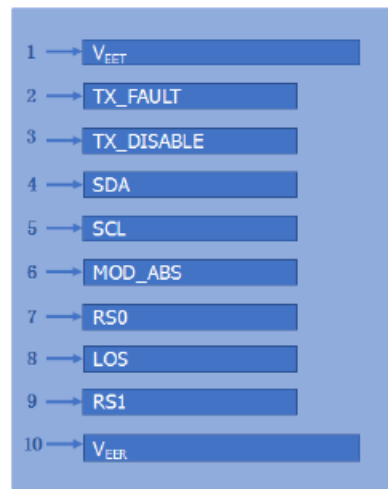
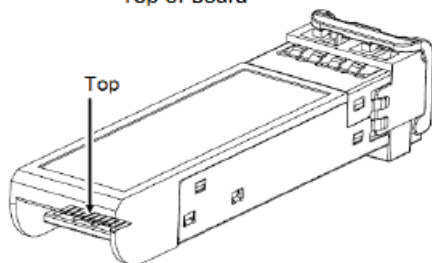

Bottom of Board

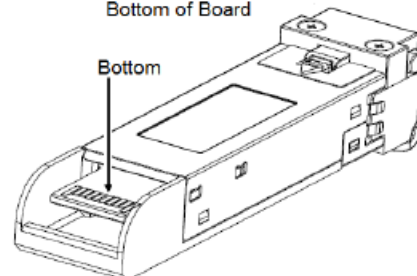

## Mechanical Specifications

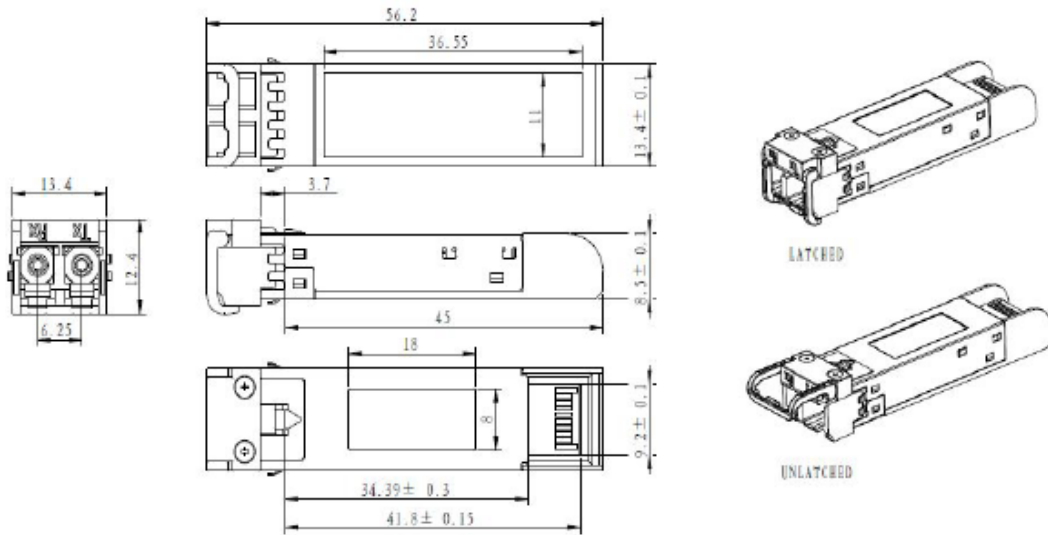

## Typical Eye Diagram

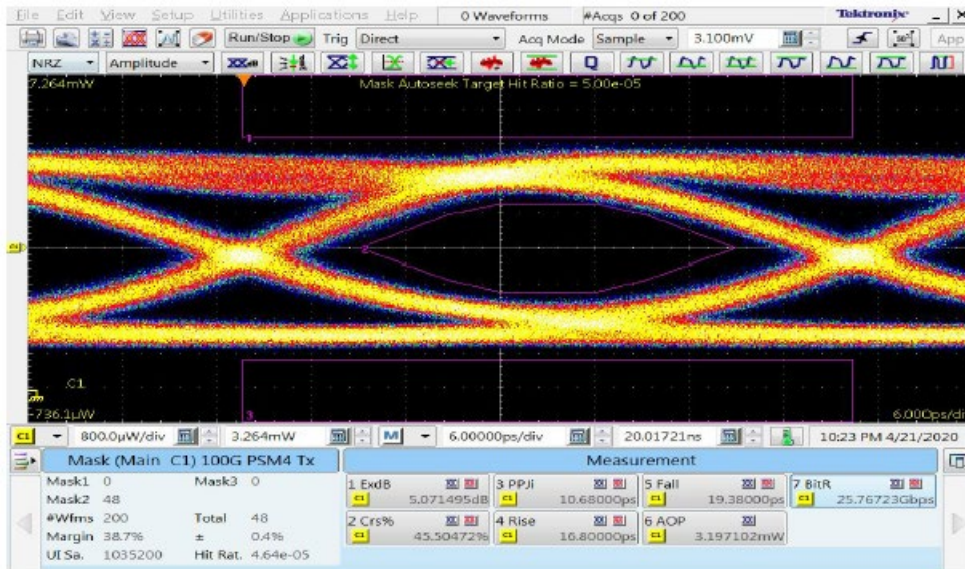

## About ProLabs

Our extensive experience comes as standard. For over 20 years ProLabs has delivered optical connectivity solutions that give our customers freedom and choice through our ability to provide seamless interoperability. At the heart of our company is the ability to provide state-of-the-art optical transport and connectivity solutions that are compatible with more than 100 optical switching and transport platforms.

## A Complete Portfolio of Network Solutions

ProLabs is focused on innovations in optical transport and connectivity. The combination of our knowledge of optics and networking equipment enables ProLabs to be your single source for optical transport and connectivity solutions from 100Mb to 1.6T while providing innovative solutions that increase network efficiency. We provide the optical connectivity expertise that is compatible with and enhances your switching and transport equipment.

## The Trusted Partner

Customer service is our number one value. ProLabs has invested in people, labs and manufacturing capacity to ensure compatible products, and immediate answers to your questions. With Engineering and Manufacturing offices in the U.K. and U.S. augmented by field offices throughout the U.S., U.K. and Asia, ProLabs is able to be our customers best advocate 24 hours a day.



## Contact Information

ProLabs US

Email: [sales@prolabs.com](mailto:sales@prolabs.com)

Telephone: 952-852-0252

ProLabs UK

Email: [salessupport@prolabs.com](mailto:salessupport@prolabs.com)

Telephone: +44 1285 719 600