

QDD-400GB-2Q56-AOC7M-AR-C

Arista Networks® Compatible TAA 400GBase-AOC QSFP-DD to 2xQSFP56 Active Optical Cable (850nm, MMF, 7m)

Features:

- Supports 26.5625GBd PAM4 and 25.78125Gbps NRZx4 Channels Per Cable
- OM3 MMF
- 850nm VCSEL and PIN Receiver
- QSFP-DD and QSFP56 MSA Package
- Hot Pluggable
- Single 3.3V Power Supply
- Maximum Power Consumption of 8.5W on QSFP-DD End and 5W on Each QSFP56 End
- Operating Temperature Range: 0 to 70 Celsius
- RoHS Compliant and Lead-Free



Applications:

- 400GBase Ethernet

Product Description

This is an Arista Networks® compatible TAA compliant 400GBase QSFP-DD 400G to 2xQSFP56 200G active optical cable that operates over multi-mode fiber with a maximum reach of 7.0m. At a wavelength of 850nm, it has been programmed, uniquely serialized, and data-traffic and application tested to ensure it is 100% compliant and functional. This active optical cable is TAA (Trade Agreements Act) compliant, and is built to comply with MSA (Multi-Source Agreement) standards. We stand behind the quality of our products and proudly offer a limited lifetime warranty.

ProLabs' transceivers are RoHS compliant and lead-free.

TAA refers to the Trade Agreements Act (19 U.S.C. & 2501-2581), which is intended to foster fair and open international trade. TAA requires that the U.S. Government may acquire only "U.S.-made or designated country end products.")



General Specifications

Parameter	Symbol	Min	Typ.	Max.	Unit
Storage Temperature	Tstg	-40		85	°C
Operating Case Temperature	Tc	0		70	°C
Supply Voltage	Vcc	0		3.63	V
Operating Humidity (Non-Condensing)		5		85	%
Supply Current	QSFP-DD	Icc		2575	
	QSFP56	Icc		1450	
Module Power Dissipation	QSFP-DD	P		8.5	
	QSFP56	P		5	
Power Supply Voltage	Vcc	3.135	3.3	3.465	V

QSFP-DD I/O Timing Characteristics

Parameter	Symbol	Min.	Typ.	Max.	Unit	Notes
MgmtInit Duration	Max. MgmtInit Duration			2000	ms	1
ResetL Assert Time	t_reset_init	10			µs	2
IntL Assert Time	ton_IntL			200	ms	3
IntL De-Assert Time	toff_IntL			500	µs	4
Rx_LOS Assert Time	ton_los			100	ms	5
Flag Assert Time	ton_flag			200	ms	6
Mask Assert Time	ton_mask			100	ms	7
Mask De-Assert Time	toff_mask			100	ms	8

Notes:

1. Time from power on, hot plug, or rising edge of reset until the completion of the MgmtInit state.
2. Minimum pulse time on the ResetL signal to initiate a module reset.
3. Time from occurrence of condition triggering IntL until VOUT: IntL=VOL.
4. Time from clear on read operation of associated flag until VOUT: IntL=VOH. This includes de-assert times for Rx_LOS, Tx_Fault, and other flag bits.
5. Time from Rx_LOS state to Rx_LOS bit is set (value = 1b), and the IntL is asserted.
6. Time from occurrence of condition triggering flag to associated flag bit is set (value = 1b), and the IntL is asserted.
7. Time from mask bit is set (value = 1b) until the associated IntL assertion is inhibited.
8. Time from mask bit is cleared (value = 0b) until the associated IntL operation resumes.

QSFP56 I/O Timing Characteristics

Parameter	Symbol	Min.	Typ.	Max.	Unit	Notes
Initialization Time	t_init			2	s	1
Reset Init Assert Time	t_reset_init	10			μs	2
Serial Bus Hardware Ready Time	t_serial			2	s	3
Monitor Data Ready Time	t_data			2	s	4
Reset Assert Time	t_reset			2	s	5
LPMode/TxDis Mode Change Time	t_LPMode/TxDis			100	ms	6
LPMode Assert Time	ton_LPMode			100	ms	7
LPMode De-Assert Time	toff_LPMode			300	ms	8
IntL/RxLOSL Mode Change Time	t_IntL/RxLOSL			100	ms	9
IntL Assert Time	ton_IntL			200	ms	10
IntL De-Assert Time	toff_IntL			500	μs	11
Rx_LOS Assert Time	ton_LOS			100	ms	12
Tx_Fault Assert Time	ton_Txfault			200	ms	13
Flag Assert Time	ton_flag			200	ms	14
Mask Assert Time	ton_mask			100	ms	15
Mask De-Assert Time	toff_mask			100	ms	16
Power Override or Power-Set Assert Time	ton_Pdown			100	ms	17
Power Override or Power-Set De-Assert Time	toff_Pdown			300	ms	18

Notes:

1. Time from power on, or hot plug, until the module is fully functional. This time applies to Power Class 2 or higher modules when LPMode is pulled “low” by the host and to all Power Class 1 modules.
2. Host is required to provide a reset pulse of at least the minimum value for the module to guarantee a reset sequence. Shorter pulses may reset the module depending on implementation.
3. Time from power on until the module responds to data transmission over the 2-wire serial bus.
4. Time from power on to “Data Not Ready,” Byte 2 Bit 0, cleared to 0 and IntL output is pulled “low.”
5. Time from a rising edge on the ResetL input until the module is fully functional.
6. Time to change between LPMode and TxDis modes of the dual mode signal LPMode/TxDis.
7. Time from when the host releases LPMode to “high” until the module’s power consumption reaches Power Class 1.
8. Time from when the host pulls LPMode “low” until the module is fully functional.
9. Time to change between IntL and RxLOSL modes of the dual mode signal IntL/RxLOSL.
10. Time from the occurrence of condition triggering an interrupt until IntL is “low.”
11. Time from clear on read operation of associated flag until module releases IntL to “high.” This includes the time to clear Rx_LOS, Tx_Fault, and other flag bits.
12. Time from Rx optical signal loss to Rx_LOS bit is set to 1, and the IntL is pulled “low” by the module.

13. Time from Tx_Fault state to Tx_Fault bit is set to 1, and the IntL is pulled “low” by the module.
14. Time from condition triggering flag to associated flag bit is set to 1, and the IntL is pulled “low” by the module.
15. Time from mask bit is set to 1 until the module is prevented from pulling the IntL “low” when the associated flag is set “high.”
16. Time from mask bit is cleared to 0 until the module is enabled to pull the IntL “low” when the associated flag is set “high.”
17. Time from Power_Override or Power_Set bit is set to 1 until the module’s power consumption reaches Power Class 1.
18. Time from Power_Override or Power_Set bit is cleared to 0 until the module is fully functional.

Optical Characteristics

Parameter	Symbol	Min.	Typ.	Max.	Unit	Notes
Transmitter						
Data Rate Per Lane	DR		26.5625		GBd	
Modulation Format	MF		PAM4			
Signaling Speed Accuracy	SSA	-100		100	ppm	
Center Wavelength	CW		850		nm	
RMS Spectral Width	$\Delta\lambda$			0.6	nm	
Average Optical Power	PO	-6.5		4	dBm	
Laser Off Power	Poff			-30	dBm	
Receiver						
Data Rate Per Lane	DR		26.5625		GBd	
Modulation Format	MF		PAM4			
Differential Data Output Voltage Pk-Pk Swing	Vopp			900	mV	
Differential Output Impedance	Zos	90	100	110	Ω	
Common-Mode Voltage	Vcm	-350		2850	mV	
Common-Mode Noise RMS				17.5	mV	
Differential Output Return Loss	SDD22	OIF CEI-56G-VSR-PAM4 and 400GAUI-8 Requirements			dB	
Common-Mode to Differential Conversion and Differential to Common-Mode Conversion	SDC22 SCD22					
Common-Mode Return Loss	SCC22			-2	dB	

QSFP-DD Pin Descriptions

Pin	Logic	Symbol	Name/Description	Plug Sequence	Notes
1		GND	Module Ground.	1B	1
2	CML-I	Tx2-	Transmitter Inverted Data Input.	3B	
3	CML-I	Tx2+	Transmitter Non-Inverted Data Input.	3B	
4		GND	Module Ground.	1B	1
5	CML-I	Tx4-	Transmitter Inverted Data Input.	3B	
6	CML-I	Tx4+	Transmitter Non-Inverted Data Input.	3B	
7		GND	Module Ground.	1B	1
8	LVTTL-I	ModSelL	Module Select.	3B	
9	LVTTL-I	ResetL	Module Reset.	3B	
10		VccRx	+3.3V Receiver Power Supply.	2B	2
11	LVC MOS-I/O	SCL	2-Wire Serial Interface Clock.	3B	
12	LVC MOS-I/O	SDA	2-Wire Serial Interface Data.	3B	
13		GND	Module Ground.	1B	1
14	CML-O	Rx3-	Transmitter Inverted Data Output.	3B	
15	CML-O	Rx3+	Transmitter Non-Inverted Data Output.	3B	
16		GND	Module Ground.	1B	1
17	CML-O	Rx1-	Transmitter Inverted Data Output.	3B	
18	CML-O	Rx1+	Transmitter Non-Inverted Data Output.	3B	
19		GND	Module Ground.	1B	1
20		GND	Module Ground.	1B	1
21	CML-O	Rx2-	Transmitter Inverted Data Output.	3B	
22	CML-O	Rx2+	Transmitter Non-Inverted Data Output.	3B	
23		GND	Module Ground.	1B	1
24	CML-O	Rx4-	Transmitter Inverted Data Output.	3B	
25	CML-O	Rx4+	Transmitter Non-Inverted Data Output.	3B	
26		GND	Module Ground.	1B	1
27	LVTTL-O	ModPrsL	Module Present.	3B	
28	LVTTL-O	IntL	Interrupt.	3B	
29		VccTx	+3.3V Transmitter Power Supply.	2B	2
30		Vcc1	+3.3V Power Supply.	2B	2
31	LVTTL-I	InitMode	Initialization Mode. In legacy QSFP applications, the InitMode pad is called LPMODE.	3B	
32		GND	Module Ground.	1B	1
33	CML-I	Tx1-	Transmitter Inverted Data Input.	3B	
34	CML-I	Tx1+	Transmitter Non-Inverted Data Input.	3B	
35		GND	Module Ground.	1B	1

36	CML-I	Tx1-	Transmitter Inverted Data Input.	3B	
37	CML-I	Tx1+	Transmitter Non-Inverted Data Input.	3B	
38		GND	Module Ground.	1B	1
39		GND	Module Ground.	1A	1
40	CML-I	Tx6-	Transmitter Inverted Data Input.	3A	
41	CML-I	Tx6+	Transmitter Non-Inverted Data Input.	3A	
42		GND	Module Ground.	1A	1
43	CML-I	Tx8-	Transmitter Inverted Data Input.	3A	
44	CML-I	Tx8+	Transmitter Non-Inverted Data Input.	3A	
45		GND	Module Ground.	1A	1
46		Reserved	Not Connected.	3A	3
47		VS1	Not Connected.	3A	3
48		VccRx1	+ 3.3V Receiver Power Supply.	2A	2
49		VS2	Not Connected.	3A	3
50		VS3	Not Connected.	3A	3
51		GND	Module Ground.	1A	1
52	CML-O	Rx7-	Transmitter Inverted Data Output.	3A	
53	CML-O	Rx7+	Transmitter Non-Inverted Data Output.	3A	
54		GND	Module Ground.	1A	1
55	CML-O	Rx5-	Transmitter Inverted Data Output.	3A	
56	CML-O	Rx5+	Transmitter Non-Inverted Data Output.	3A	
57		GND	Module Ground.	1A	1
58		GND	Module Ground.	1A	1
59	CML-O	Rx6-	Transmitter Inverted Data Output.	3A	
60	CML-O	Rx6+	Transmitter Non-Inverted Data Output.	3A	
61		GND	Module Ground.	1A	1
62	CML-O	Rx8-	Transmitter Inverted Data Output.	3A	
63	CML-O	Rx8+	Transmitter Non-Inverted Data Output.	3A	
64		GND	Module Ground.	1A	1
65		NC	Not Connected.	3A	3
66		Reserved	Not Connected.	3A	3
67		VccTx1	+3.3V Transmitter Power Supply.	2A	2
68		Vcc2	+3.3V Power Supply.	2A	2
69		Reserved	Not Connected.	3A	3
70		GND	Module Ground.	1A	1
71	CML-I	Tx7-	Transmitter Inverted Data Input.	3A	
72	CML-I	Tx7+	Transmitter Non-Inverted Data Input.	3A	

73		GND	Module Ground.	1A	1
74	CML-I	Tx5-	Transmitter Inverted Data Input.	3A	
75	CML-I	Tx5+	Transmitter Non-Inverted Data Input.	3A	
76		GND	Module Ground.	1A	1

Notes:

1. QSFP-DD uses common ground (GND) for all signals and supply (power). All are common within the QSFP-DD module, and all module voltages are referenced to this potential unless otherwise noted. Connect these directly to the host board signal common ground plane. This pin is an open collector/drain output pin and shall be pulled up with 4.7kΩ to 10kΩ to the Host_Vcc on the host board. Pull-ups can be connected to multiple power supplies; however, the host board design shall ensure that no module pin has a voltage exceeding the module VccT/R+0.5V.
2. VccRx, VccRx1, Vcc1, Vcc2, VccTx, and VccTx1 shall be applied concurrently. Requirements defined for the host side of the Host Card Edge Connector are listed below. VccRx, VccRx1, Vcc1, Vcc2, VccTx, and VccTx1 may be internally connected within the module in any combination. The connector Vcc pins are each rated for a maximum current of 1000mA.
3. All Vendor-Specific, Reserved, and Not Connected pins may be terminated with 50Ω to the ground on the host. Pad 65 (Not Connected) shall be left unconnected within the module. Vendor-Specific and Reserved pads shall have an impedance to the GND that is greater than 10kΩ and less than 100pF.
4. Plug Sequence specifies the mating sequence of the host connector and the module. The sequence is 1A, 2A, 3A, 1B, 2B, and 3B. See below for pad locations. Contact Sequence A will make, then break contact with additional QSFP-DD pads. Sequence 1A, 1B will then occur simultaneously, followed by 2A, 2B, followed by 3A, 3B.

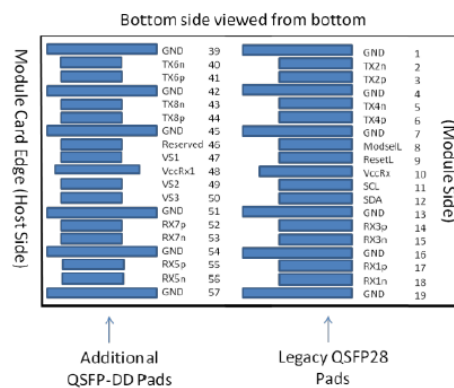
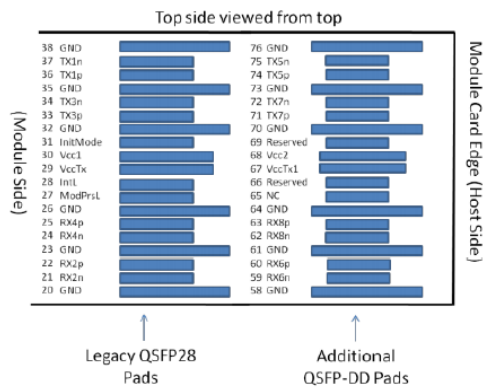

QSF56 Pin Descriptions

Pin	Symbol	Name/Description	Notes
1	GND	Module Ground.	1
2	Tx2-	Transmitter Inverted Data Input.	
3	Tx2+	Transmitter Non-Inverted Data Input.	
4	GND	Module Ground.	1
5	Tx4-	Transmitter Inverted Data Input.	
6	Tx4+	Transmitter Non-Inverted Data Input.	
7	GND	Module Ground.	
8	ModSelL	Module Select.	
9	ResetL	Module Reset.	
10	VccRx	+3.3V Receiver Power Supply.	2
11	SCL	2-Wire Serial Interface Clock.	
12	SDA	2-Wire Serial Interface Data.	
13	GND	Module Ground.	
14	Rx3+	Receiver Non-Inverted Data Output.	
15	Rx3-	Receiver Inverted Data Output.	
16	GND	Module Ground.	1
17	Rx1+	Receiver Non-Inverted Data Output.	
18	Rx1-	Receiver Inverted Data Output.	1
19	GND	Module Ground.	1
20	GND	Module Ground.	
21	Rx2-	Receiver Inverted Data Output.	
22	Rx2+	Receiver Non-Inverted Data Output.	
23	GND	Module Ground.	
24	Rx4-	Receiver Inverted Data Output.	
25	Rx4+	Receiver Non-Inverted Data Output.	
26	GND	Module Ground.	1
27	ModPrsL	Module Present.	
28	IntL/RxLOSL	Interrupt. Optionally configurable as RxLOSL via the management interface (SFF-8636).	
29	VccTx	+3.3V Transmitter Power Supply.	2
30	Vcc1	+3.3V Power Supply.	2
31	LPMoDe/TxDis	Low-Power Mode. Optionally configurable as TxDis via the management interface (SFF-8636).	
32	GND	Module Ground.	1
33	Tx3+	Transmitter Non-Inverted Data Input.	
34	Tx3-	Transmitter Inverted Data Input.	
35	GND	Module Ground.	1

36	Tx1+	Transmitter Non-Inverted Data Input.	
37	Tx1-	Transmitter Inverted Data Input.	
38	GND	Module Ground.	1

Notes:

1. GND is the symbol for signal and power supply common for the module. All are common within the module, and all module voltages are referenced to this potential unless otherwise noted. Connect these directly to the host board signal common ground plane.
2. VccRx, Vcc1, and VccTx are applied concurrently and may be internally connected within the module in any combination. Vcc contacts in SFF-8662 and SFF-8672 each have a steady state current rating of 1A.

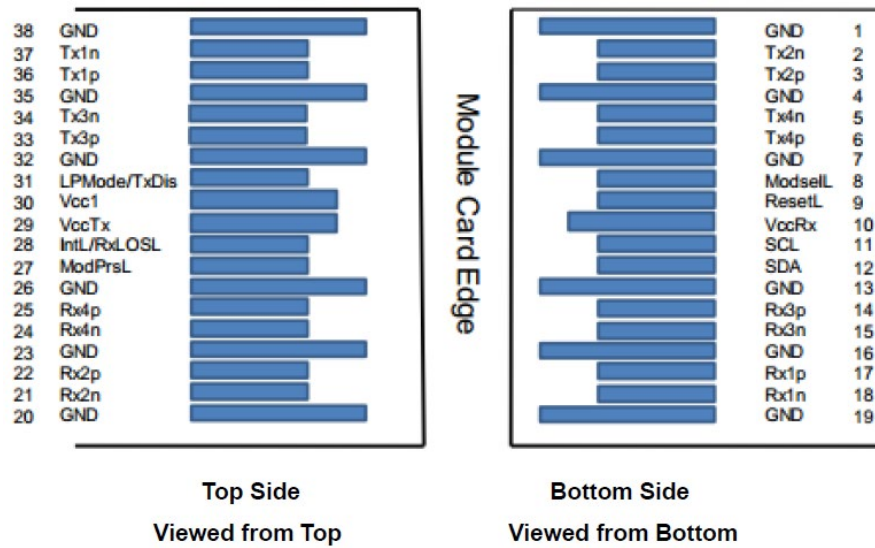

QSFP-DD Block Diagram of Transceiver

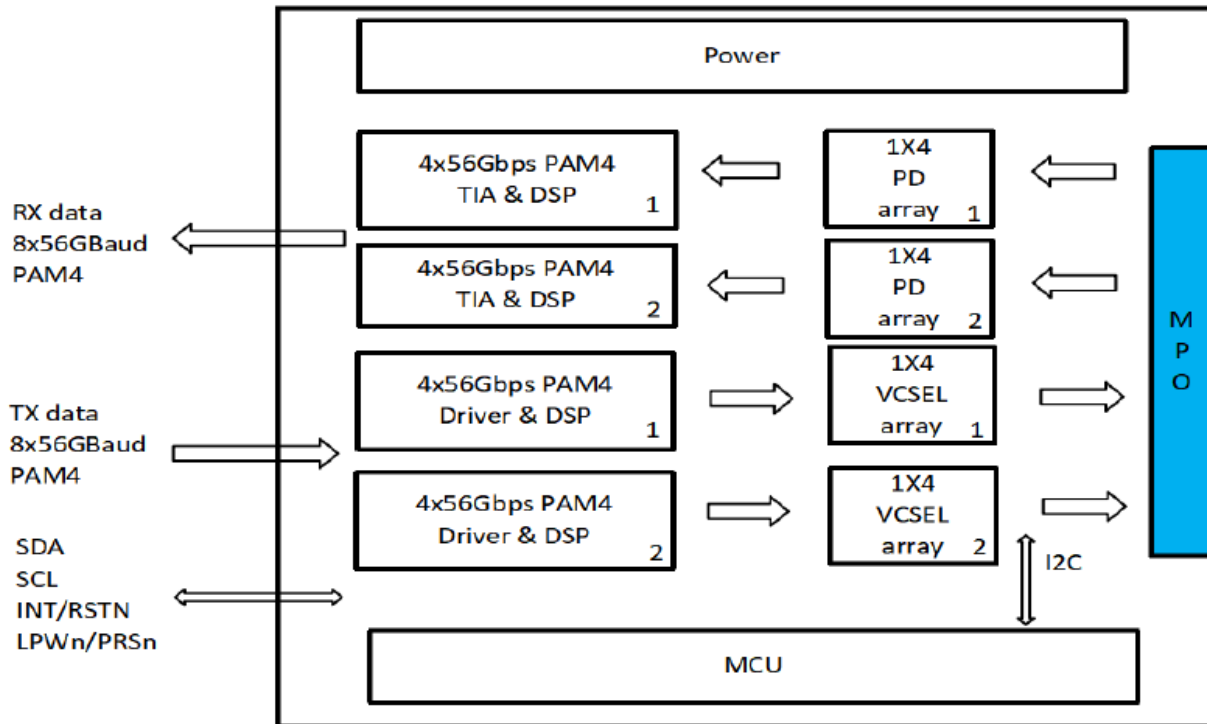

QSFP56 Block Diagram of Transceiver

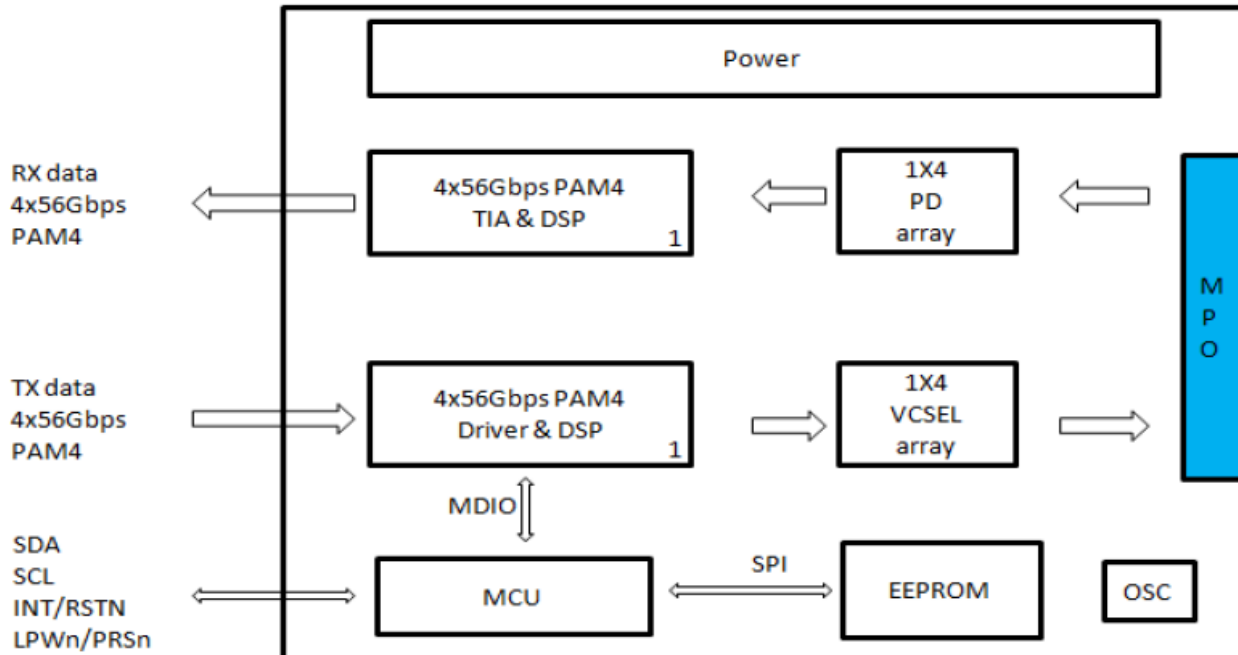

QSFP-DD Host Board

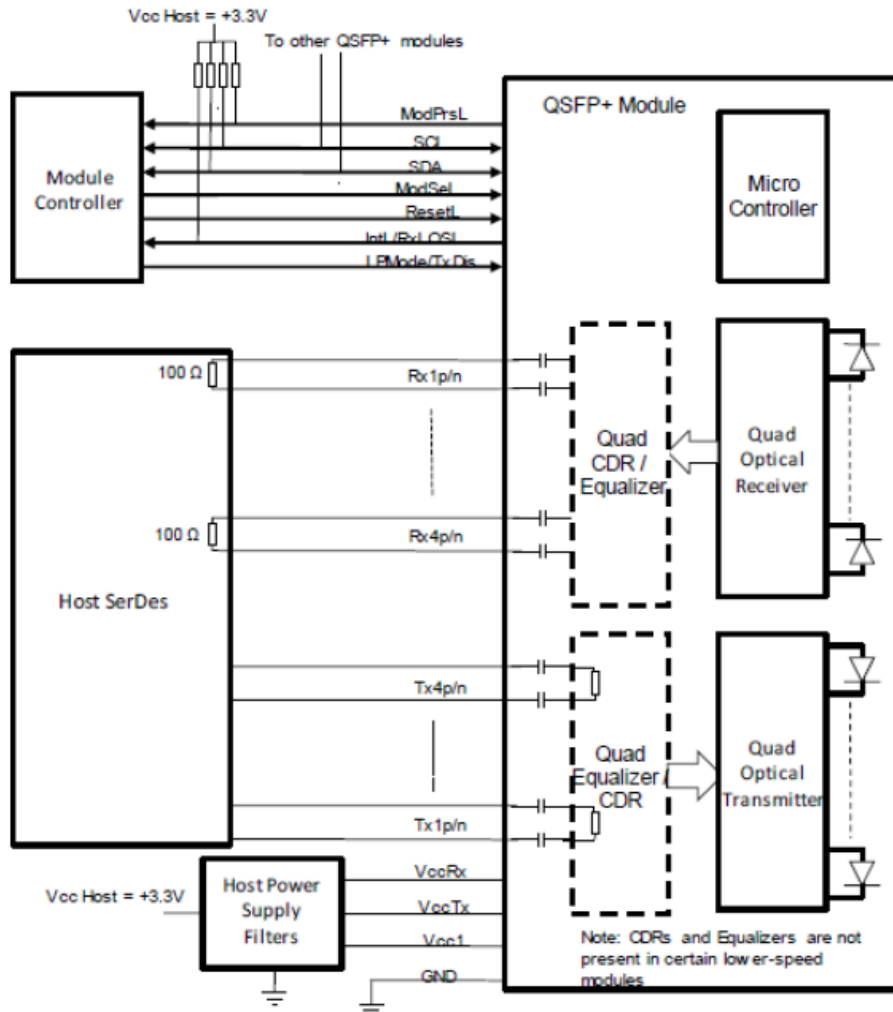

QSFP56 Host Board

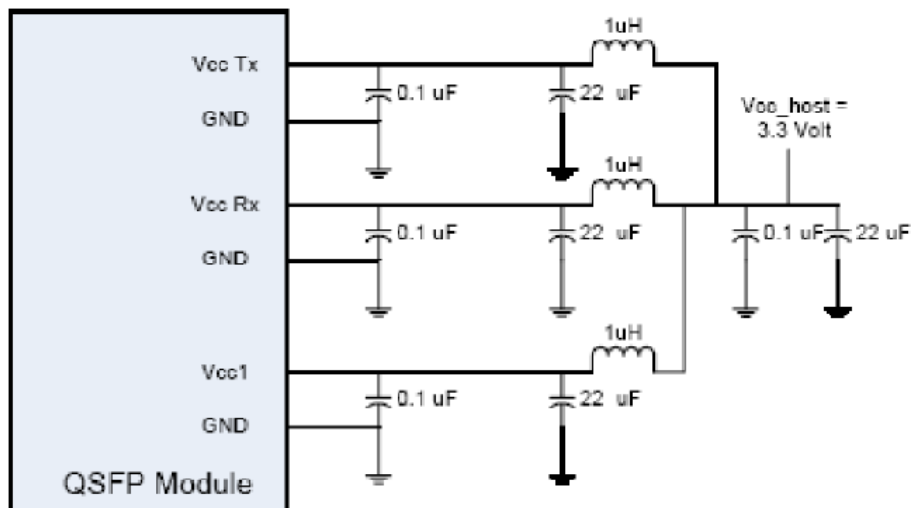

Mechanical Specifications

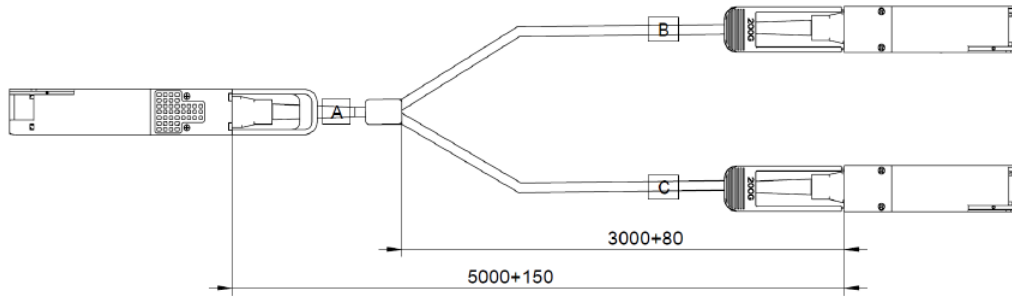

QSFP-DD Mechanical Specifications

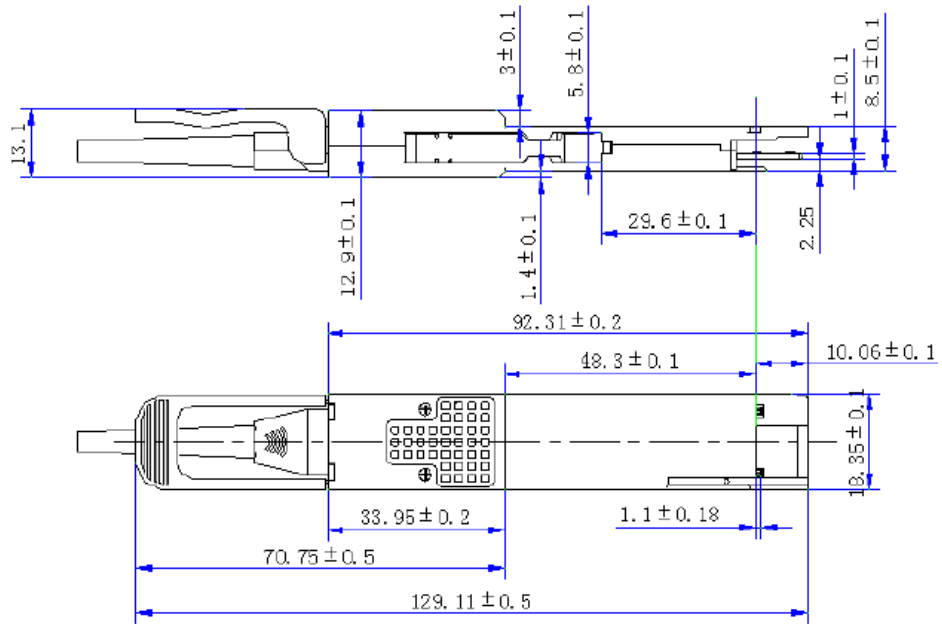

QSFP56 Mechanical Specifications

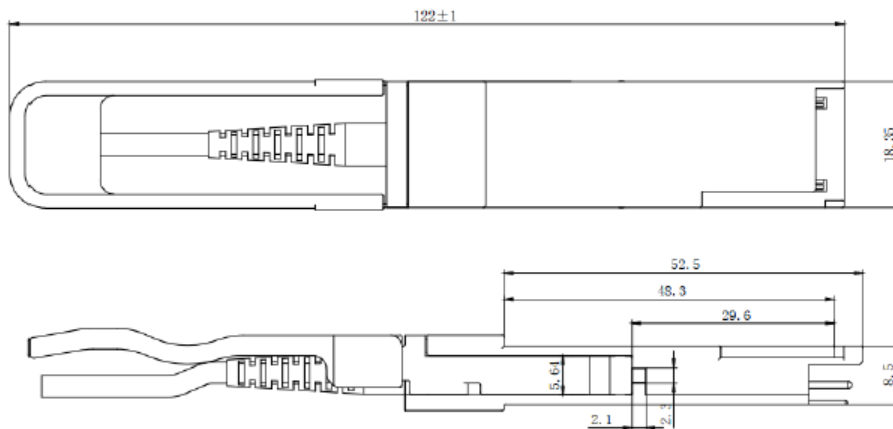

About ProLabs

Our extensive experience comes as standard. For over 20 years ProLabs has delivered optical connectivity solutions that give our customers freedom and choice through our ability to provide seamless interoperability. At the heart of our company is the ability to provide state-of-the-art optical transport and connectivity solutions that are compatible with more than 100 optical switching and transport platforms.

A Complete Portfolio of Network Solutions

ProLabs is focused on innovations in optical transport and connectivity. The combination of our knowledge of optics and networking equipment enables ProLabs to be your single source for optical transport and connectivity solutions from 100Mb to 1.6T while providing innovative solutions that increase network efficiency. We provide the optical connectivity expertise that is compatible with and enhances your switching and transport equipment.

The Trusted Partner

Customer service is our number one value. ProLabs has invested in people, labs and manufacturing capacity to ensure compatible products, and immediate answers to your questions. With Engineering and Manufacturing offices in the U.K. and U.S. augmented by field offices throughout the U.S., U.K. and Asia, ProLabs is able to be our customers best advocate 24 hours a day.



Contact Information

ProLabs US

Email: sales@prolabs.com

Telephone: 952-852-0252

ProLabs UK

Email: salessupport@prolabs.com

Telephone: +44 1285 719 600