

OSFP-800GB-AEC-2-5M-AR-C

Arista Networks® Compatible TAA 800GBase-AEC OSFP to OSFP Active Electrical Cable (AEC, 2.5m, CMIS 5.0)

Features:

- 8-Lane Active Transceiver, Supports Data Rates up to 800Gbps
- 8x106.25Gbps Tx and 8x106.25Gbps Rx Parallel Channels
- Hot-Pluggable OSFP Type 1 Form Factor, MSA Compliant
- Power Consumption: 8.0W Per Cable End
- PAM4 Encoding
- CMIS 5.4
- Single 3.3V Power Supply
- Operating Temperature Range: 0 to 70 Celsius
- RoHS Compliant and Lead-Free



Applications:

- 800GBase Ethernet

Product Description

This is an Arista Networks® compatible 800GBase-AEC OSFP to OSFP active electrical cable that operates over active copper with a maximum reach of 2.5m (8.2ft). It has been programmed, uniquely serialized, and data-traffic and application tested to ensure it is 100% compliant and functional. This active electrical cable is TAA (Trade Agreements Act) compliant, and is built to comply with MSA (Multi-Source Agreement) standards. We stand behind the quality of our products and proudly offer a limited lifetime warranty.

ProLabs' transceivers are RoHS compliant and lead-free.

TAA refers to the Trade Agreements Act (19 U.S.C. & 2501-2581), which is intended to foster fair and open international trade. TAA requires that the U.S. Government may acquire only "U.S.-made or designated country end products."



General Specifications

Parameter	Symbol	Min.	Typ.	Max.	Unit	Notes
Storage Temperature	Tstg	-40		85	°C	
Operating Case Temperature	Tc	0		70	°C	
Relative Operating Humidity	RH	5		85	%	
Bend Radius		3			cm	
Data Rate Per Channel	DR		53.125		GBd	
Aggregate Bit Rate	BRAVE		800		Gbps	
Lane Bit Rate	BRLANE		106.25		Gbps	1
Label Bit Tolerance		-100		100	ppm	
Bit Error Ratio	BER			2.4E ⁻⁴		2
2-Wire Serial Interface	I2C		400	1000	kHz	3

Notes:

1. PAM4.
2. Pre-FEC.
3. Timing per CMIS 5.x.

Physical Characteristics

Parameter	Symbol	Min.	Typ.	Max.	Unit	Notes
Length	L			2.5	M	
AWG			30		AWG	
Jacket Material	Plastic Braided Mesh Technology Net					

Electrical Specifications

Parameter	Symbol	Min.	Typ.	Max.	Unit	Notes
Supply Voltage	Vcc	3.13	3.3	3.47	V	
Power Dissipation Per End	PD		6.5	8.0	W	
ESD Rating High-Speed Signal Pins	VESD_IO	-1		1	kV	
ESD Rating All Pins Except High-Speed Signal Pins	VESD	-2		2	kV	
SCL and SDA Outputs	VOL	0		0.4	V	
SCL and SDA Inputs	VIL	-0.3		Vcc*0.3	V	
	VIH	Vcc*0.7		Vcc+0.5	V	
INT/RSTn	H_Vref_INT	2.475	2.5	2.525	V	
	M_Vref_RSTn	1.238	1.25	1.263	V	
	V_INT/RSTN_1	0	0	1	V	
	V_INT/RSTN_2	0	0	1	V	
	V_INT/RSTN_3	1.5	1.9	2.25	V	
	V_INT/RSTN_4	2.75	3.0	3.465	V	
LPWn/PRSn	H_Vref_PRSn	2.475	2.5	2.525	V	
	M_Vref_LPWn	1.238	1.25	1.263	V	
	V_LPWn/PRSn_1	0	0.95	1.1	V	
	V_LPWn/PRSn_2	1.4	1.7	2.25	V	
	V_LPWn/PRSn_3	2.75	3.3	3.465	V	
Transmitter						
Single-Ended Input Voltage		-0.35		2.85	V	
Differential Pk-Pk Input Voltage	VIN,pp	900			mVp-p	
Differential Input Impedance	ZIN	80	100	120	Ω	
Differential to Common-Mode Return Loss	SCD11	IEEE802.3ck_Equation (120G-2)			dB	
Effective Return Loss (ERL)				8.5	dB	
Differential Termination Mismatch				10	%	
Receiver						
Single-Ended Output Voltage		-0.35		2.85	V	
AC Common-Mode Voltage				17.5	mV	
Differential Output Voltage Swing	VOUT,pp			900	mVp-p	
Differential Output Impedance	ZOUT	80	100	120	Ω	
Common-Mode to Differential Return Loss	SCD11	IEEE802.3ck_Equation (120G-1)			dB	
Effective Return Loss (ERL)		8.5			dB	
Differential Termination Mismatch				10	!	
Transition Time (20-80%)	Tr/Tf	8.5			ps	

Pin Descriptions

Pin	Symbol	Name/Description	Logic	Plug Sequence	Direction	Notes
1	GND	Module Ground.		1		
2	Tx2+	Transmitter Data Non-Inverted.	CML-I	3	Input from Host	
3	Tx2-	Transmitter Data Inverted.	CML-I	3	Input from Host	
4	GND	Module Ground.		1		
5	Tx4+	Transmitter Data Non-Inverted.	CML-I	3	Input from Host	
6	Tx4-	Transmitter Data Inverted.	CML-I	3	Input from Host	
7	GND	Module Ground.		1		
8	Tx6+	Transmitter Data Non-Inverted.	CML-I	3	Input from Host	
9	Tx6-	Transmitter Data Inverted.	CML-I	3	Input from Host	
10	GND	Module Ground.		1		
11	Tx8+	Transmitter Data Non-Inverted.	CML-I	3	Input from Host	
12	Tx8-	Transmitter Data Inverted.	CML-I	3	Input from Host	
13	GND	Module Ground.		1		
14	SCL	2-Wire Serial Interface Clock.	LVCMOS-I/O	3	Bi-Directional	1
15	Vcc	+3.3V Power.		2	Power from Host	
16	Vcc	+3.3V Power.		2	Power from Host	
17	LPWn/PRSn	Low-Power Mode/Module Present.	Multi-Level	3	Bi-Directional	2
18	GND	Module Ground.		1		
19	Rx7-	Receiver Data Inverted.	CML-O	3	Output from Host	
20	Rx7+	Receiver Data Non-Inverted.	CML-O	3	Output from Host	
21	GND	Module Ground.		1		
22	Rx5-	Receiver Data Inverted.	CML-O	3	Output from Host	
23	Rx5+	Receiver Data Non-Inverted.	CML-O	3	Output from Host	
24	GND	Module Ground.		1		
25	Rx3-	Receiver Data Inverted.	CML-O	3	Output from Host	
26	Rx3+	Receiver Data Non-Inverted.	CML-O	3	Output from Host	
27	GND	Module Ground.		1		
28	Rx1-	Receiver Data Inverted.	CML-O	3	Output from Host	
29	Rx1+	Receiver Data Non-Inverted.	CML-O	3	Output from Host	
30	GND	Module Ground.		1		
31	GND	Module Ground.		1		
32	Rx2+	Receiver Data Non-Inverted.	CML-O	3	Output from Host	
33	Rx2-	Receiver Data Inverted.	CML-O	3	Output from Host	
34	GND	Module Ground.		1		
35	Rx4+	Receiver Data Non-Inverted.	CML-O	3	Output from Host	

36	Rx4-	Receiver Data Inverted.	CML-O	3	Output from Host	
37	GND	Module Ground.		1		
38	Rx6+	Receiver Data Non-Inverted.	CML-O	3	Output from Host	
39	Rx6-	Receiver Data Inverted.	CML-O	3	Output from Host	
40	GND	Module Ground.		1		
41	Rx8+	Receiver Data Non-Inverted.	CML-O	3	Output from Host	
42	Rx8-	Receiver Data Inverted.	CML-O	3	Output from Host	
43	GND	Module Ground.		1		
44	INT/RSTn	Module Interrupt/Module Reset.	Multi-Level	3	Bi-Directional	2
45	Vcc	+3.3V Power.		2	Power from Host	
46	Vcc	+3.3V Power.		2	Power from Host	
47	SDA	2-Wire Serial Interface Data.	LVC MOS-I/O	3	Bi-Directional	1
48	GND	Module Ground.		1		
49	Tx7-	Transmitter Data Inverted.	CML-I	3	Input from Host	
50	Tx7+	Transmitter Data Non-Inverted.	CML-I	3	Input from Host	
51	GND	Module Ground.		1		
52	Tx5-	Transmitter Data Inverted.	CML-I	3	Input from Host	
53	Tx5+	Transmitter Data Non-Inverted.	CML-I	3	Input from Host	
54	GND	Module Ground.		1		
55	Tx3-	Transmitter Data Inverted.	CML-I	3	Input from Host	
56	Tx3+	Transmitter Data Non-Inverted.	CML-I	3	Input from Host	
57	GND	Module Ground.		1		
58	Tx1-	Transmitter Data Inverted.	CML-I	3	Input from Host	
59	Tx1+	Transmitter Data Non-Inverted.	CML-I	3	Input from Host	
60	GND	Module Ground.		1		

Notes:

1. Open-drain with pull-up resistor on the host.
2. See below for the required circuit.

Electrical Pin-Out Details

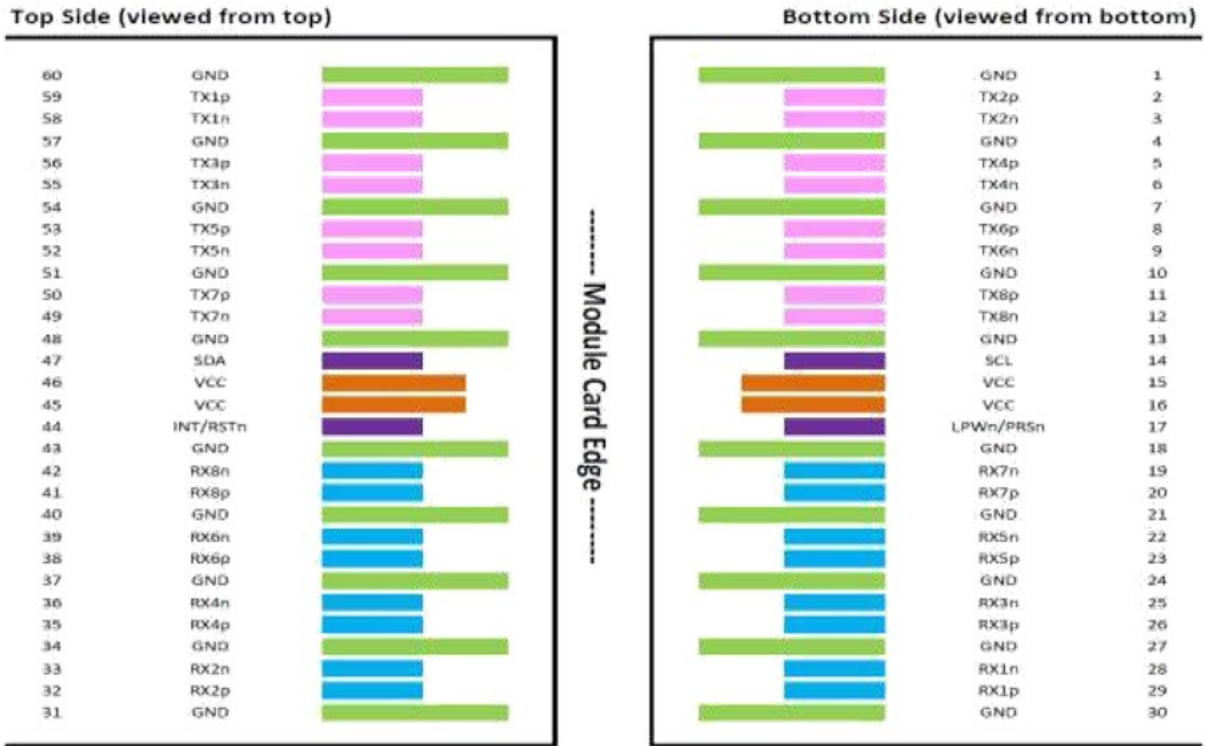

Block Diagram

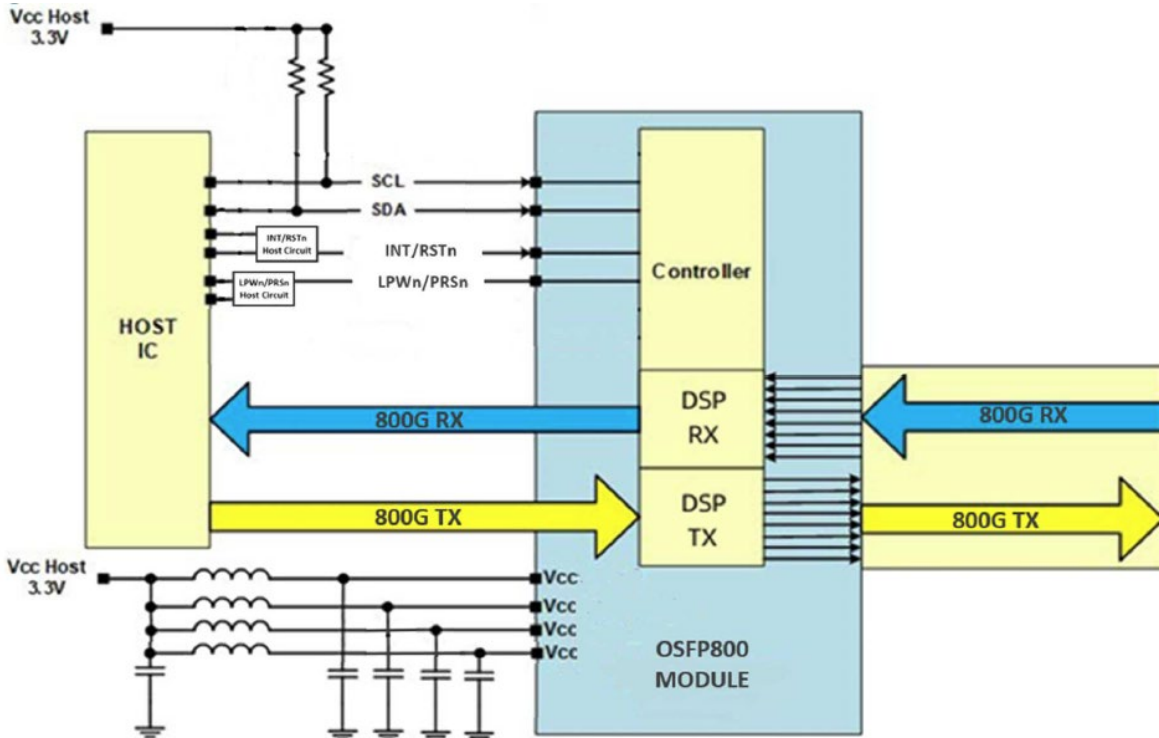

Mechanical Specifications

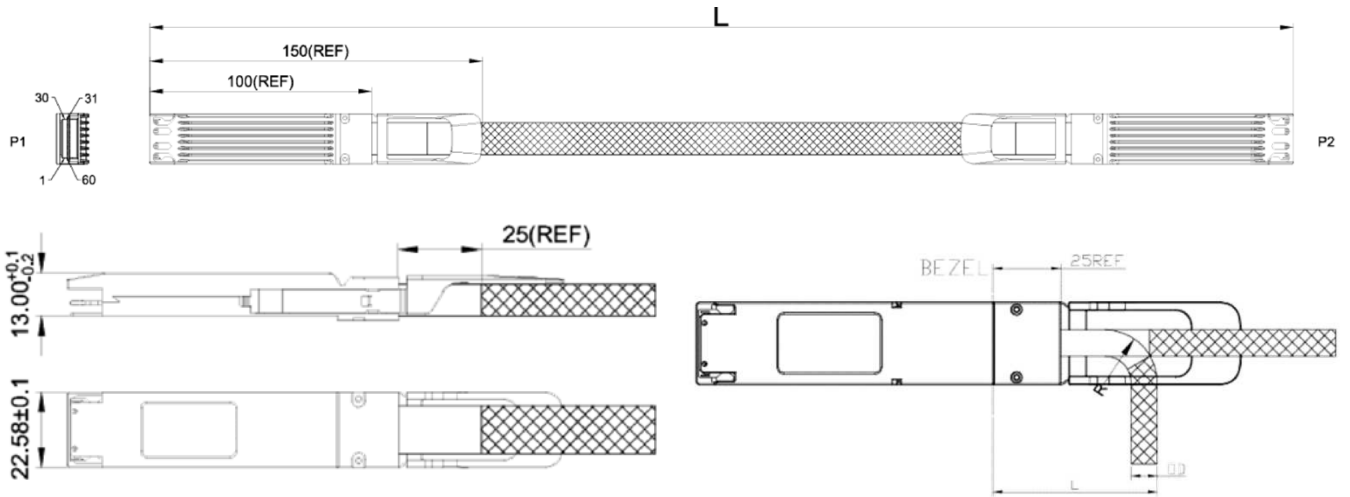

Bending Radius

Wire Gauge	OD (Ref.)	Bend Radius "R"	Min. Bend Radius "L"
30AWG	9.5mm	19mm	65mm

About ProLabs

Our extensive experience comes as standard. For over 20 years ProLabs has delivered optical connectivity solutions that give our customers freedom and choice through our ability to provide seamless interoperability. At the heart of our company is the ability to provide state-of-the-art optical transport and connectivity solutions that are compatible with more than 100 optical switching and transport platforms.

A Complete Portfolio of Network Solutions

ProLabs is focused on innovations in optical transport and connectivity. The combination of our knowledge of optics and networking equipment enables ProLabs to be your single source for optical transport and connectivity solutions from 100Mb to 1.6T while providing innovative solutions that increase network efficiency. We provide the optical connectivity expertise that is compatible with and enhances your switching and transport equipment.

The Trusted Partner

Customer service is our number one value. ProLabs has invested in people, labs and manufacturing capacity to ensure compatible products, and immediate answers to your questions. With Engineering and Manufacturing offices in the U.K. and U.S. augmented by field offices throughout the U.S., U.K. and Asia, ProLabs is able to be our customers best advocate 24 hours a day.



Contact Information

ProLabs US

Email: sales@prolabs.com

Telephone: 952-852-0252

ProLabs UK

Email: salessupport@prolabs.com

Telephone: +44 1285 719 600