

SFP56-50GB-PDAC2M-AR-AO

Arista Networks® Compatible TAA 50GBase-CU SFP56 to SFP56 Direct Attached Cable (Passive Twinax, 2m)

Features

- Up to 50Gbps Bi-Directional Data Links
- Compliant with SFF-8402
- Hot-Pluggable
- Single 3.3V Power Supply
- Operating Temperature: 0 to 70 Celsius
- Enhanced EMI Design
- RoHS Compliant and Lead-Free



Applications

- 50GBase Ethernet

Product Description

This is an Arista Networks® compatible 50GBase-CU SFP56 to SFP56 direct attach cable that operates over passive copper with a maximum reach of 2.0m (6.6ft). It has been programmed, uniquely serialized, and data-traffic and application tested to ensure it is 100% compliant and functional. This direct attach cable is TAA (Trade Agreements Act) compliant, and is built to comply with MSA (Multi-Source Agreement) standards. We stand behind the quality of our products and proudly offer a limited lifetime warranty.

AddOn's transceivers are RoHS compliant and lead-free.

TAA refers to the Trade Agreements Act (19 U.S.C. & 2501-2581), which is intended to foster fair and open international trade. TAA requires that the U.S. Government may acquire only "U.S.-made or designated country end products."



Absolute Maximum Ratings

Parameter	Symbol	Min.	Typ.	Max.	Unit	Notes
Data Rate	DR		50		Gbps	1
Bit Error Rate	BER			10 ⁻¹²		
Operating Temperature	Tc	0		70	°C	2
Storage Temperature	Tstg	-40		85	°C	3
Supply Voltage	Vcc	3.14	3.3	3.46	V	4
Supply Current	Icc			4	mA	4
Product Weight	GD		78		g/PCS	5
Cable Weight	GC		32		g/M	
Dust Cap Weight	GS		0.80		g/PCS	

Notes:

1. IEEE 802.3cd.
2. Case temperature.
3. Ambient temperature.
4. For the electrical power interface.
5. The total weight of the cable. For example, the weight of a 3M cable is $90 + 44*(3-1) + 0.80*2 = 179.6g$.

Cable Specifications

Parameter	Symbol	Min.	Typ.	Max.	Unit	Notes
Wire Gauge				30	AWG	
Cable Impedance	Z	90	100	110	Ω	

Cable Dimension and Nominal Length

Standard Wire Gauge (AWG)	Cable Diameter OD (mm)	Minimum Bending Radius R (mm)	Nominal Length (m)	Tolerance Range ± (cm)
30	4.6	26	Length≤2	2

Pin Descriptions

Pin	Symbol	Name/Description	Notes
1	VeeT	Transmitter Ground (Common with Receiver Ground).	1
2	Tx_Fault	Transmitter Failure Alarm. Not Used.	
3	Tx_Disable	The signal turns off the module transmitter when it is “high” or “open.” Not Used.	
4	SDA	Data Line for Serial ID.	2
5	SCL	Clock Line for Serial ID.	2
6	MOD_ABS	Module Absent. Grounded within the module.	2
7	RS0	No Connection Required.	
8	LOS	Loss of Signal Indication. “Logic 0” indicates normal operation.	
9	RS1	No Connection Required.	
10	VeeR	Receiver Ground (Common with Transmitter Ground).	1
11	VeeR	Receiver Ground (Common with Transmitter Ground).	1
12	RD-	Receiver Inverted Data Out. AC Coupled.	
13	RD+	Receiver Non-Inverted Data Out. AC Coupled.	
14	VeeR	Receiver Ground (Common with Transmitter Ground).	1
15	VccR	Receiver Power Supply.	
16	VccT	Transmitter Power Supply.	
17	VeeT	Transmitter Ground (Common with Receiver Ground).	1
18	TD+	Transmitter Non-Inverted Data In. AC Coupled.	
19	TD-	Transmitter Inverted Data In. AC Coupled.	
20	VeeT	Transmitter Ground (Common with Receiver Ground).	1

Notes:

1. The circuit ground is isolated from the chassis ground.
2. SFF-8472 specification for management interface for SFP+.

Electrical Pin-Out Details



Block Diagram of Transceiver

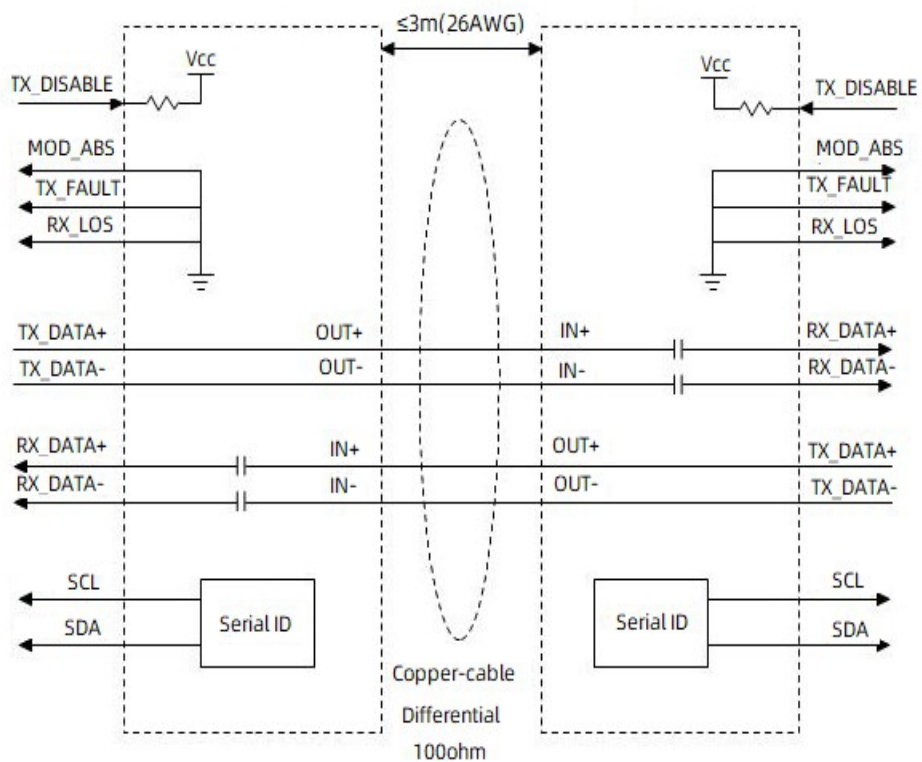

Mechanical Specifications

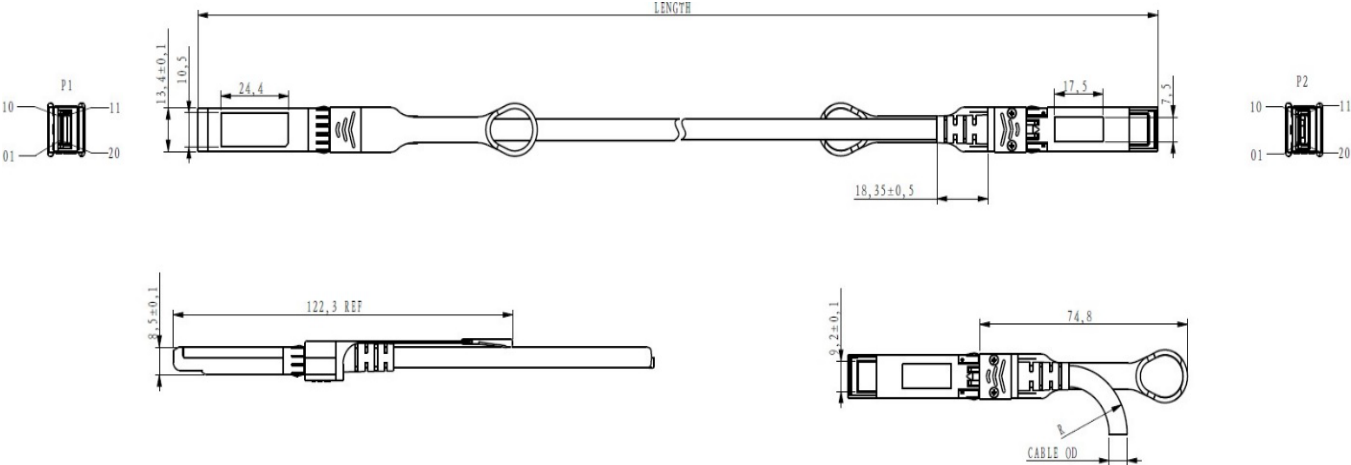

All dimensions are ±0.2mm unless otherwise specified.
 Unit: mm

About AddOn Networks

In 1999, AddOn Networks entered the market with a single product. Our founders fulfilled a severe shortage for compatible, cost-effective optical transceivers that compete at the same performance levels as leading OEM manufacturers. Adhering to the idea of redefining service and product quality not previously had in the fiber optic networking industry, AddOn invested resources in solution design, production, fulfillment, and global support.

Combining one of the most extensive and stringent testing processes in the industry, an exceptional free tech support center, and a consistent roll-out of innovative technologies, AddOn has continually set industry standards of quality and reliability throughout its history.

Reliability is the cornerstone of any optical fiber network and is ingrained in AddOn's DNA. It has played a key role in nurturing the long-term relationships developed over the years with customers. AddOn remains committed to exceeding industry standards with certifications ranging from NEBS Level 3 to ISO 9001:2015 with every new development while maintaining the signature reliability of its products.



U.S. Headquarters

Email: sales@addonnetworks.com

Telephone: +1 877.292.1701

Fax: 949.266.9273

Europe Headquarters

Email: salesemea@addonnetworks.com

Telephone: +44 1285 842070