

# Armstrong® Integrated Lighting for WoodWorks® Linear

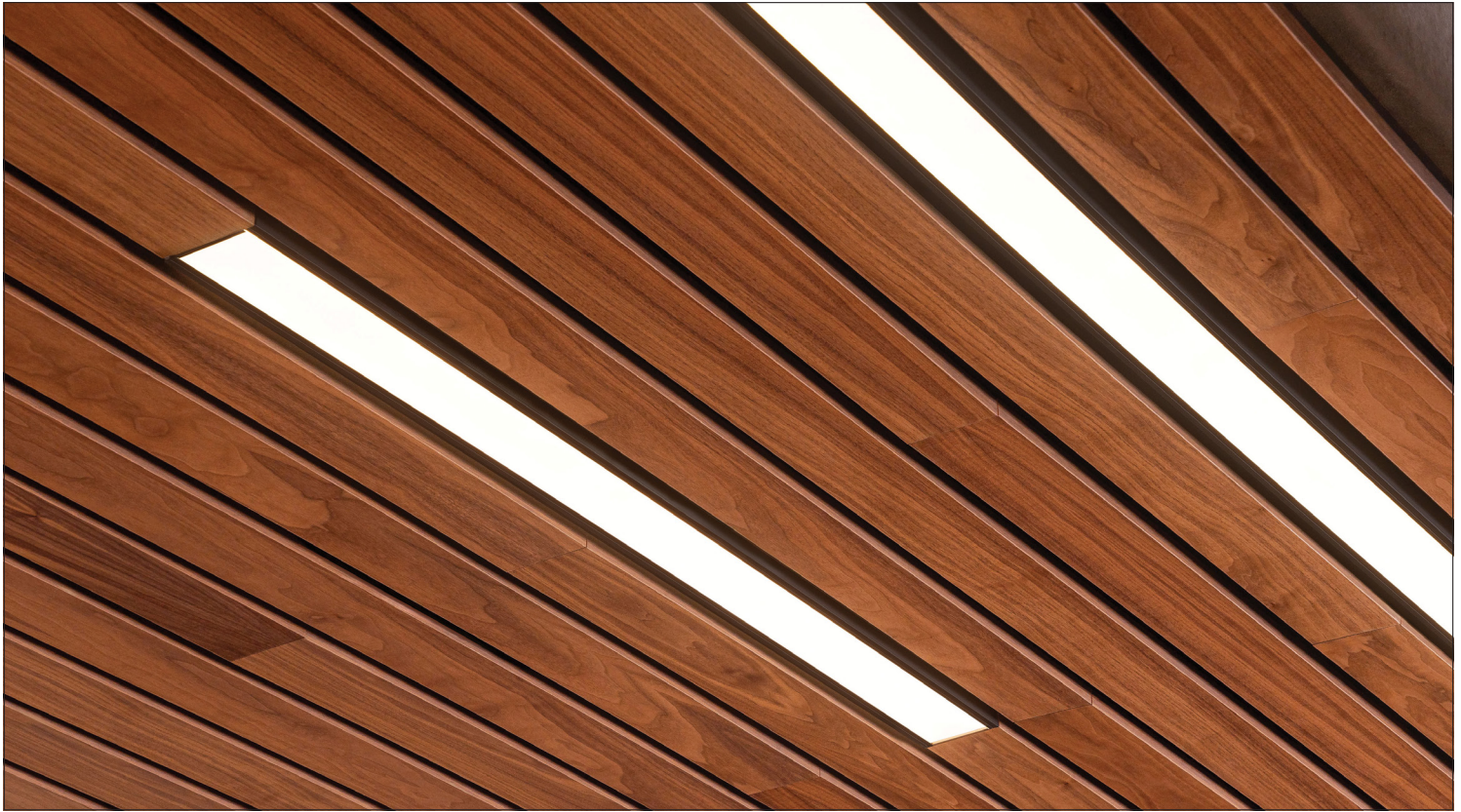

WoodWorks® Linear Veneered Open with 3.75" integrated lighting

---

## Specifications

### Lighting

Solid state LED system 120v–277v input 2700k, 3000k, 3500k, 4000k options, 90 CRI light source options

Our high-fidelity LED technology delivers stunning 90 CRI color accuracy with tight chromaticity control and the efficiency you expect from 80 CRI boards, giving lighting designers greater control over how materials, textures, and brand colors appear in real-world environments.

### Dimming

Dimming 0–10v

### Mounting

Integrates into the WoodWorks® Linear Veneered Open ceiling system. Standard fixture mounting meets DSA and OSHPD requirements. Additional hardware and safety lanyards are available for securing to the T grid.

### Certification

CSA approved to UL Standards  
Declare label certified  
Living Building Challenge compliant  
Damp rated  
Seismic Zone Certified

### Cleaning & Care

Designed to withstand the demands of rigorous cleaning requirements. Effective cleaning and disinfection of environmental surfaces reduces microbe transmission. Superior chemical resistance and durability promotes safety in any design application. Use common disinfectants and cleaners to reduce microbe transmission.

### Warranty

5 year warranty when used as a complete system with WoodWorks® Linear Veneered Open planks

# Armstrong® Integrated Lighting

Fixture Options



## Lighting Dimensions

Lengths & Widths *Custom lengths available*



48" L

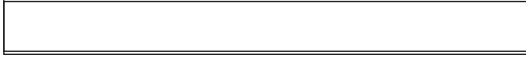

72" L



96" L

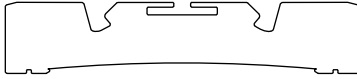

3.75" W

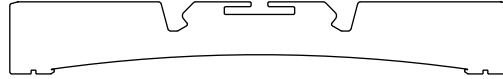

5.25" W

## Light Placement

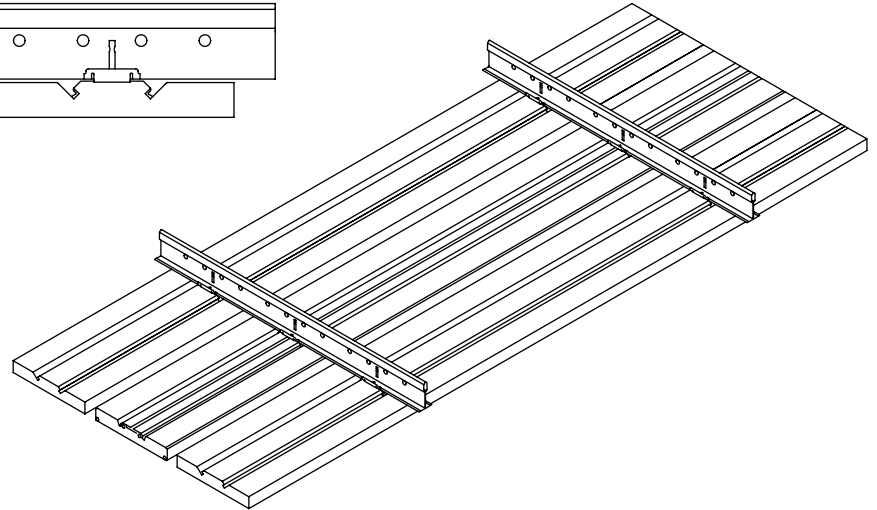
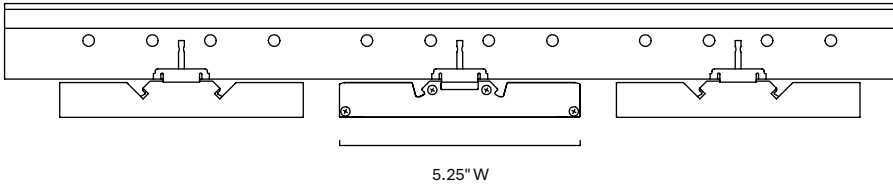

# Armstrong® Integrated Lighting Lighting Details



## Light Distribution Options

Consult factory or [lightart.com](http://lightart.com) for IES files, tested in accordance with IESNA LM79

END VIEW

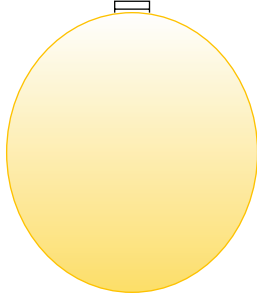

SIDE VIEW

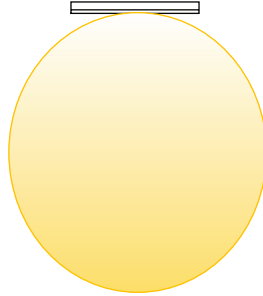

TOP VIEW

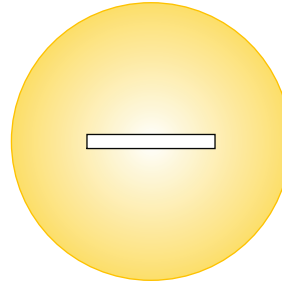

## Performance

Based on 3500K / 90CRI / Standard Distribution

NOMINAL LUMEN OUTPUT (LM/FT)	INPUT POWER (W/FT)		EFFICACY (LM/W)	
	3.75"	5.25"	3.75"	5.25"
400	4.21	3.76	95.10	106.25
500	5.35	4.79	93.41	104.29
600	6.50	5.85	92.31	102.51
700	7.65	6.88	91.54	101.71
800	8.82	7.94	90.67	100.74
900	10.00	9.00	90.00	100.00
1000	11.18	10.06	89.47	99.42
1100	12.38	11.15	88.84	98.68

(If fixture power is under 15W, please specify a 120V or 277V driver)

## Light Distribution

Based on measurement data

COLOR TEMPERATURE / CRI	MULTIPLIER
2700K / 90	0.98
3000K / 90	1.00
3500K / 90	1.00
4000K / 90	1.03

### OUTPUT MULTIPLIERS INSTRUCTIONS

Adjusted Value =  $L_1 \bar{y} C_m \bar{y}$  where:

$L_1$  = (Lumen output at 3500K / 90 CRI)  $\bar{y}$

$C_m$  = (Color Temp. / CRI Multiplier)  $\bar{y}$

Example:

850LM / 4000K / 90CRI

$(850) \bar{y} (1.03) \bar{y} = 875.5LM$

# Armstrong® Integrated Lighting

SKU Specification



**SPECIFICATION CODE**

EXAMPLE: 2 QTY AIL-WOOD-LINEAR-3.75-48L-935CK-600LM-EBM-STD-NO

QTY. AIL-WOOD-LINEAR-
  <sup>1</sup> -
  <sup>2</sup> -
  <sup>3</sup> -
  <sup>4</sup> -
  <sup>5</sup> -
  <sup>6</sup> -
  <sup>7</sup>

Complete form to order WoodWorks® Linear Veneered Open. For each number, make one selection and enter in the corresponding box above.  
 \*Indicates modified choices; additional lead times and/or costs may apply.

**1 PROFILE**

- 3.75 3.75"
- 5.25 5.25"

**2 LENGTH (Nominal)**

- 48L 48" LENGTH
- 60L 60" LENGTH
- 72L 72" LENGTH
- 84L 84" LENGTH
- 96L 96" LENGTH
- CRL CUSTOM RUN LENGTH  
*Max run length in 24" increments*

**3 LED CRI / CCT**

- 927CK 90 CRI / 2700K
- 930CK 90 CRI / 3000K
- 935CK 90 CRI / 3500K
- 940CK 90 CRI / 4000K

**4 OUTPUT**

- 400LM 400 LM/FT
- 500LM 500 LM/FT
- 600LM 600 LM/FT
- 700LM 700 LM/FT
- 800LM 800 LM/FT
- 900LM 900 LM/FT
- 1000LM 1000 LM/FT
- 1100LM 1100 LM/FT

**5 DIMMING AND CONTROLS**

- P01 0-10V 1% DIMMING
- LEC\* HI-LUME 1% ECOSYSTEM LED DRIVER SOFT ON, FADE TO BLACK (LDE1 SERIES)
- EBM 0-10V 1% DIMMING INTEGRATED EM BATTERY OPTION  
*Max lumen output limited - consult LightArt; only available for 48" L and 96" L configurations*

**6 REMOTE DRIVER BOX CORD LENGTH**

- STD 8'
- EXT\* 20'

**7 SEISMIC ZONE MOUNTING**

- YES YES  
*Checking "YES" will include additional hardware and safety lanyards for securing to the T grid*
- NO NO