



Armstrong® Integrated Lighting

for WoodWorks® Ceiling Panels



Integrated
Lighting

Armstrong®
World Industries

LightArt

WoodWorks® Linear

Create bold, directional ceiling designs with integrated lighting tailored for WoodWorks® Linear Veneered Open system. Continuous lines of light emphasize the linear geometry of the ceiling while providing consistent, high-quality illumination below.



*WoodWorks® Linear Open Ceiling Panels with
5.25" integrated lighting in White Ash finish*

WoodWorks® Grille

Elevate the ceiling plane with fully integrated linear lighting designed specifically for select WoodWorks® Grille systems. This solution unifies architecture and illumination, delivering clean lines of light that align seamlessly with wood slats for a refined, continuous aesthetic.



*WoodWorks® Grille Forté Solid Ceiling Panels with
1.50" integrated lighting in Rich Mahogany finish*

An Integrated System

Designed to work as a complete solution, lighting and ceiling panels install together with a coordinated clip-in system that simplifies specification and installation. Factory-aligned components ensure no modifications, with consistent spacing, clean transitions and reliable performance.



WoodWorks® Grille Forté

Configuration Examples

Specify lighting across a range of widths, placements, and ceiling systems to create unique visual expressions.

- Continuous runs that extend across panel joints
- Seamless transitions through ceiling planes
- Slat replacement or between-slat light positioning (Grille systems)

Designed for flexibility, the system supports long, uninterrupted runs — allowing light to define space without being constrained by panel dimensions.

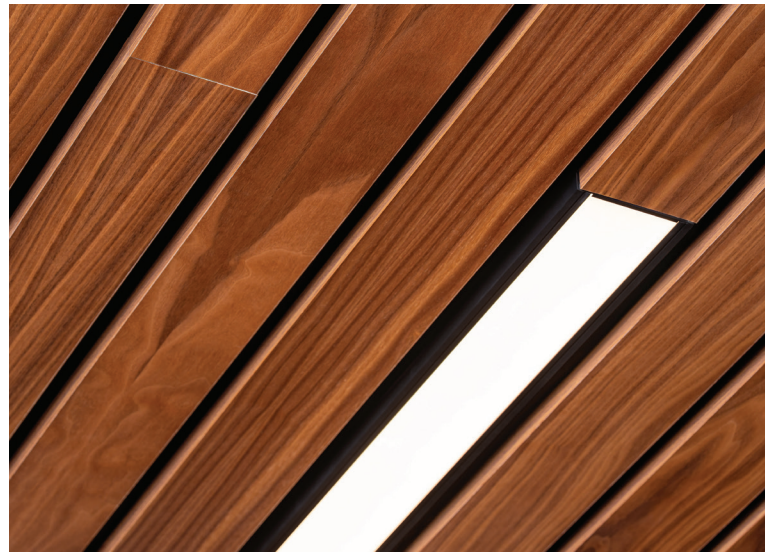

WoodWorks® Linear Veneered Open Ceiling Panels with 3.75" integrated lighting

Lighting & Performance

Our high-fidelity LED technology delivers stunning 90 CRI color accuracy with tight chromaticity control and the efficiency you expect from 80 CRI boards, giving lighting designers greater control over how materials, textures, and brand colors appear in real-world environments.



WoodWorks® Grille Forté

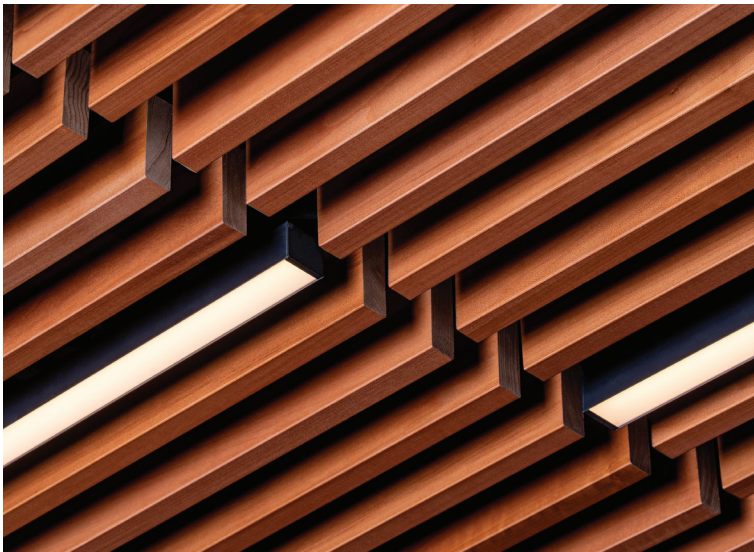

WoodWorks® Grille Forté Solid Ceiling Panels with 1.50" integrated lighting; slat replacement

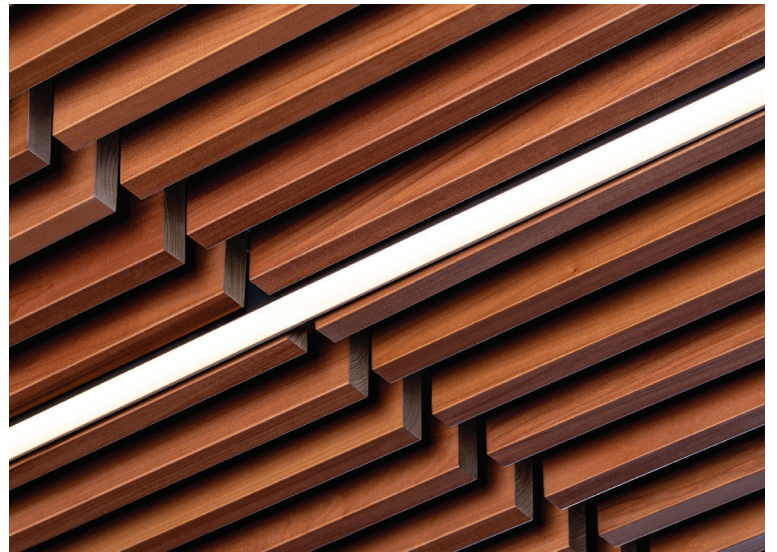

WoodWorks® Grille Forté Solid Ceiling Panels with 1.50" integrated lighting; between-slat and continued run across panel joint

Specifications

Lighting

Solid state LED system 120v–277v input 2700k, 3000k, 3500k, 4000k options, 90 CRI light source options.

Mounting*

Integrates into the WoodWorks® Grille Forté Veneered, WoodWorks® Grille Forté Solid, WoodWorks® Grille Classics ceiling panels, and WoodWorks® Linear Veneered Open ceiling planks.

Dimming

0–10v

Certification

CSA approved to UL Standards
 Declare label certified
 Living Building Challenge compliant
 Damp rated
 Seismic Zone Certified

Warranty

5 year warranty when used as a complete system with WoodWorks® Grille Forté Veneered, WoodWorks® Grille Forté Solid, WoodWorks® Grille Classics ceiling panels, and WoodWorks® Linear Veneered Open ceiling planks

WoodWorks® Grille

Lengths & Widths

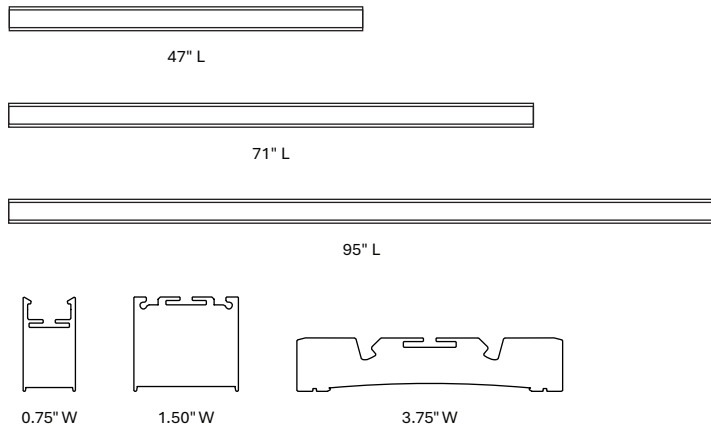

Light Placement

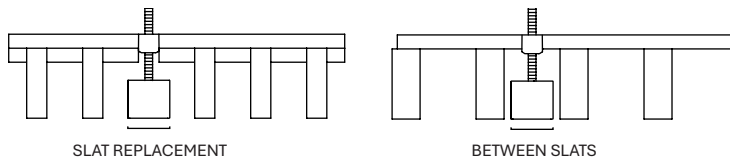

*(Grille) Standard fixture mounting meets the desired qualification level for California. Additional hardware and safety lanyards are available for securing to the T grid, meeting DSA and OSHPD requirements.

WoodWorks® Linear

Lengths & Widths

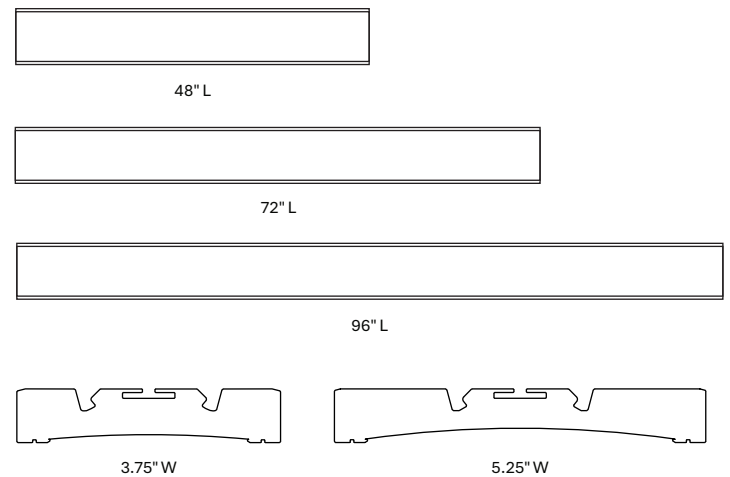

Light Placement

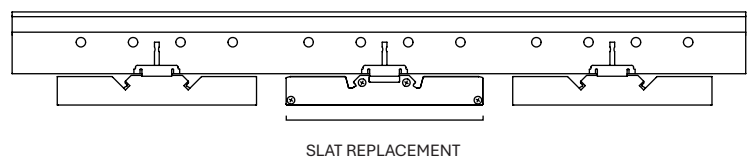

*(Linear) Standard fixture mounting meets DSA and OSHPD requirements. Additional hardware and safety lanyards are available for securing to the T grid.